



US00D540906S

(12) **United States Design Patent**
Hardwick

(10) **Patent No.:** **US D540,906 S**

(45) **Date of Patent:** **** Apr. 17, 2007**

(54) **DISPENSER HOUSING**

6,210,566 B1 * 4/2001 King 210/169
D503,770 S * 4/2005 Costa et al. D23/207

(75) Inventor: **Leonard P. Hardwick**, Naples, FL
(US)

* cited by examiner

(73) Assignee: **King Technologies, Inc.**, Hopkins, MN
(US)

Primary Examiner—Robin Webster

(74) *Attorney, Agent, or Firm*—Jacobson & Johnson

(**) Term: **14 Years**

(57) **CLAIM**

The ornamental design for a dispenser housing, as shown.

(21) Appl. No.: **29/236,586**

DESCRIPTION

(22) Filed: **Aug. 18, 2005**

(51) **LOC (8) Cl.** **23-01**

FIG. 1 is a perspective view of a dispenser housing, showing my design;

(52) **U.S. Cl.** **D23/208; D23/207**

FIG. 2 is a front elevation view of the dispenser housing;

(58) **Field of Classification Search** D23/208,

FIG. 3 is a left side elevation view of the dispenser housing;

D23/207, 209, 210; 210/416.2, 169; 422/264-5
See application file for complete search history.

FIG. 4 is a back side elevation view of the dispenser housing;

FIG. 5 is a right side elevation view of the dispenser housing;

(56) **References Cited**

U.S. PATENT DOCUMENTS

D273,033 S * 3/1984 Sangster et al. D23/207
D309,493 S * 7/1990 Casberg D23/208
D328,333 S * 7/1992 Casberg D23/208
5,427,748 A * 6/1995 Wiedrich et al. 422/284

FIG. 6 is a top view of the dispenser housing; and,

FIG. 7 is a bottom view of the dispenser housing.

The broken line showing is for illustrative purposes only and forms no part of the claimed design.

1 Claim, 3 Drawing Sheets

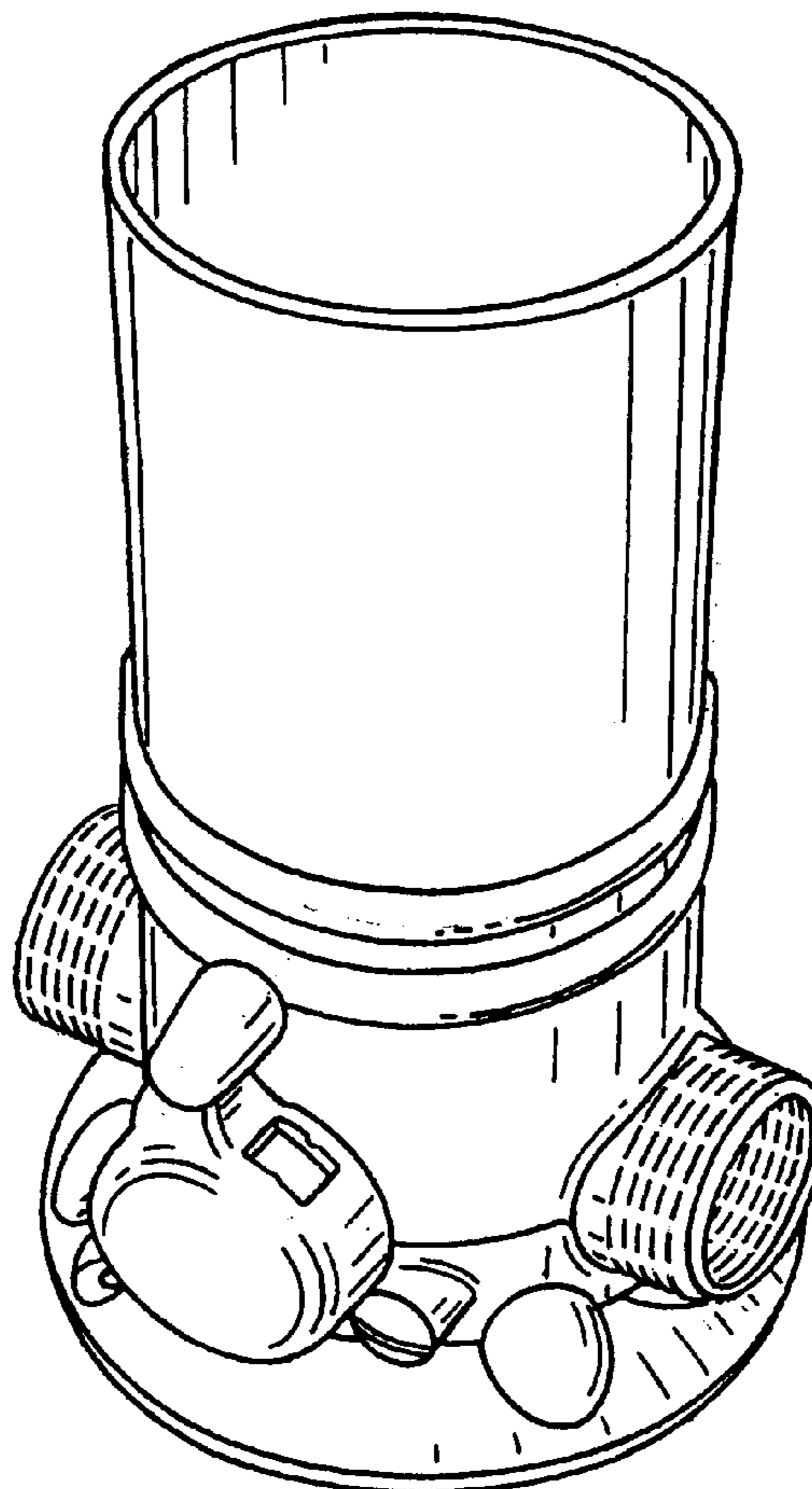

FIG. 1

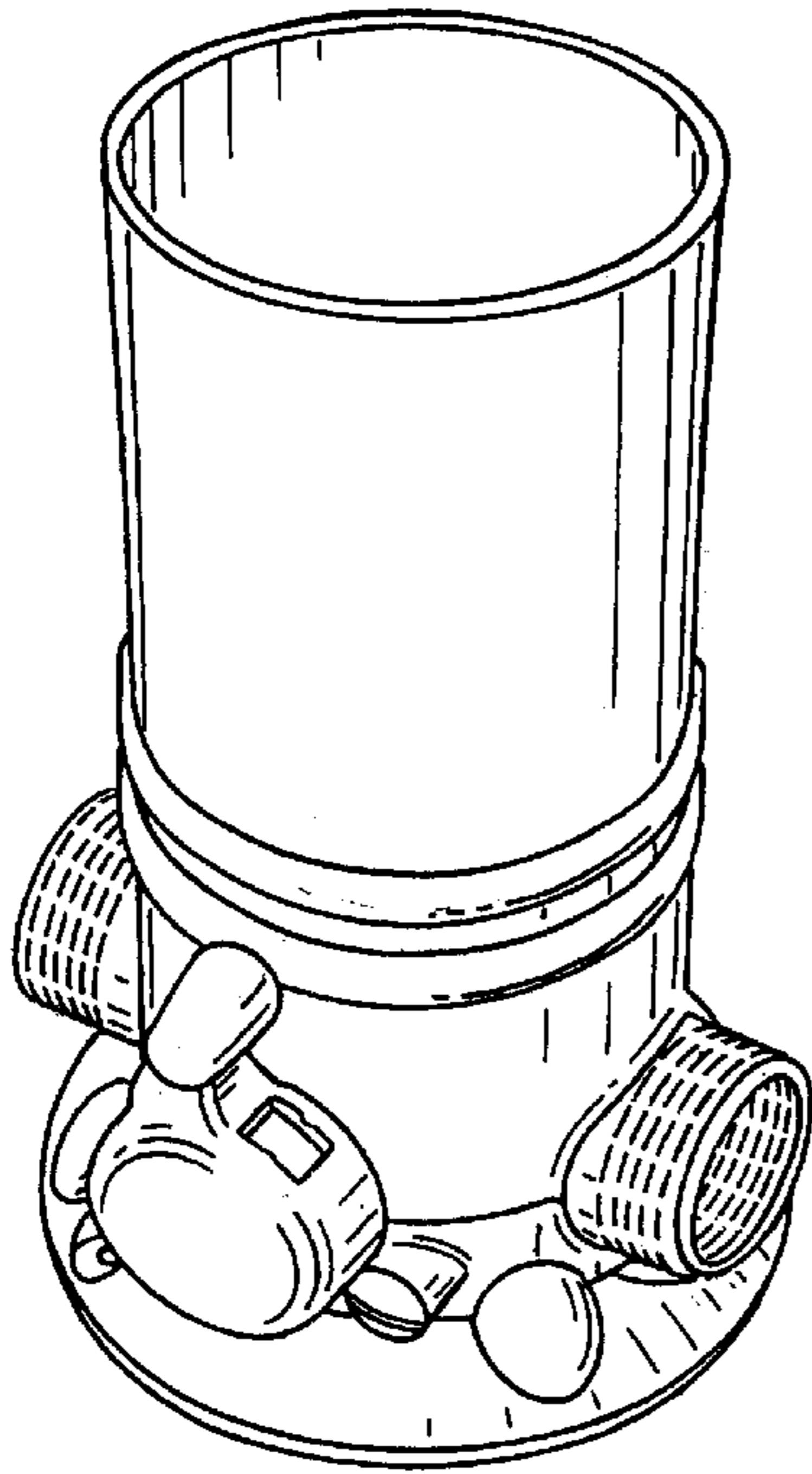

FIG. 2

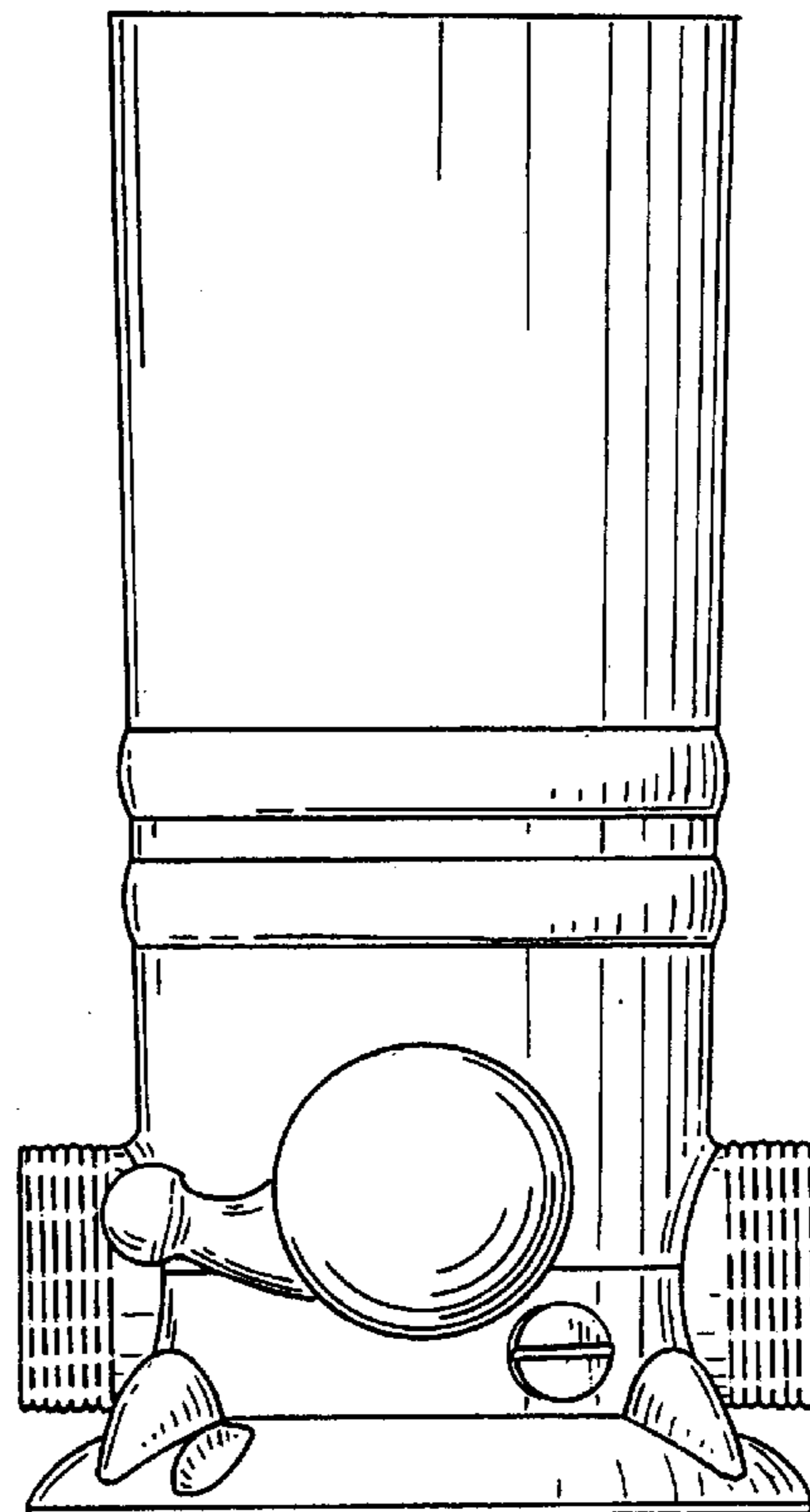

FIG. 3

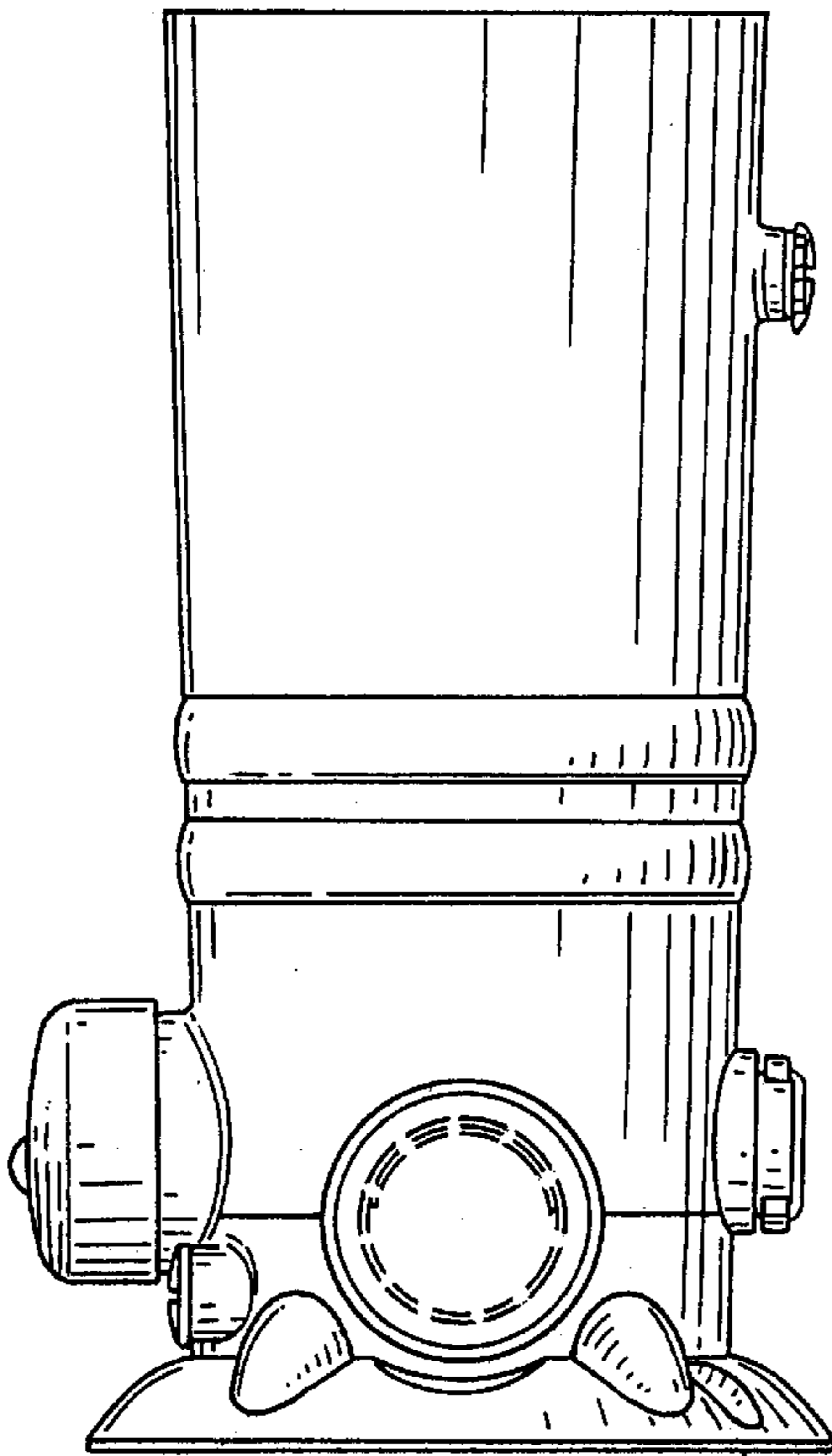

FIG. 4

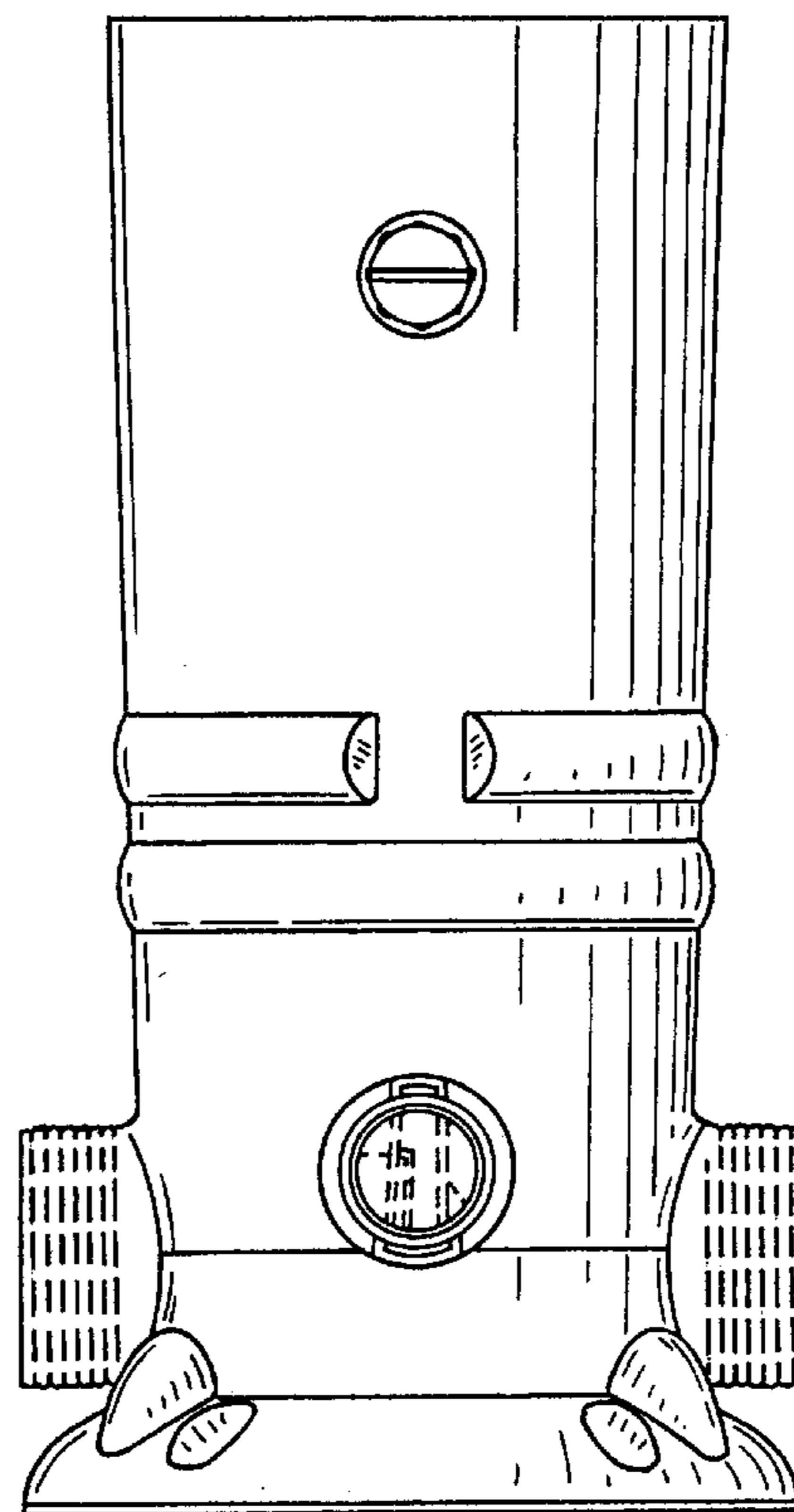

FIG. 5

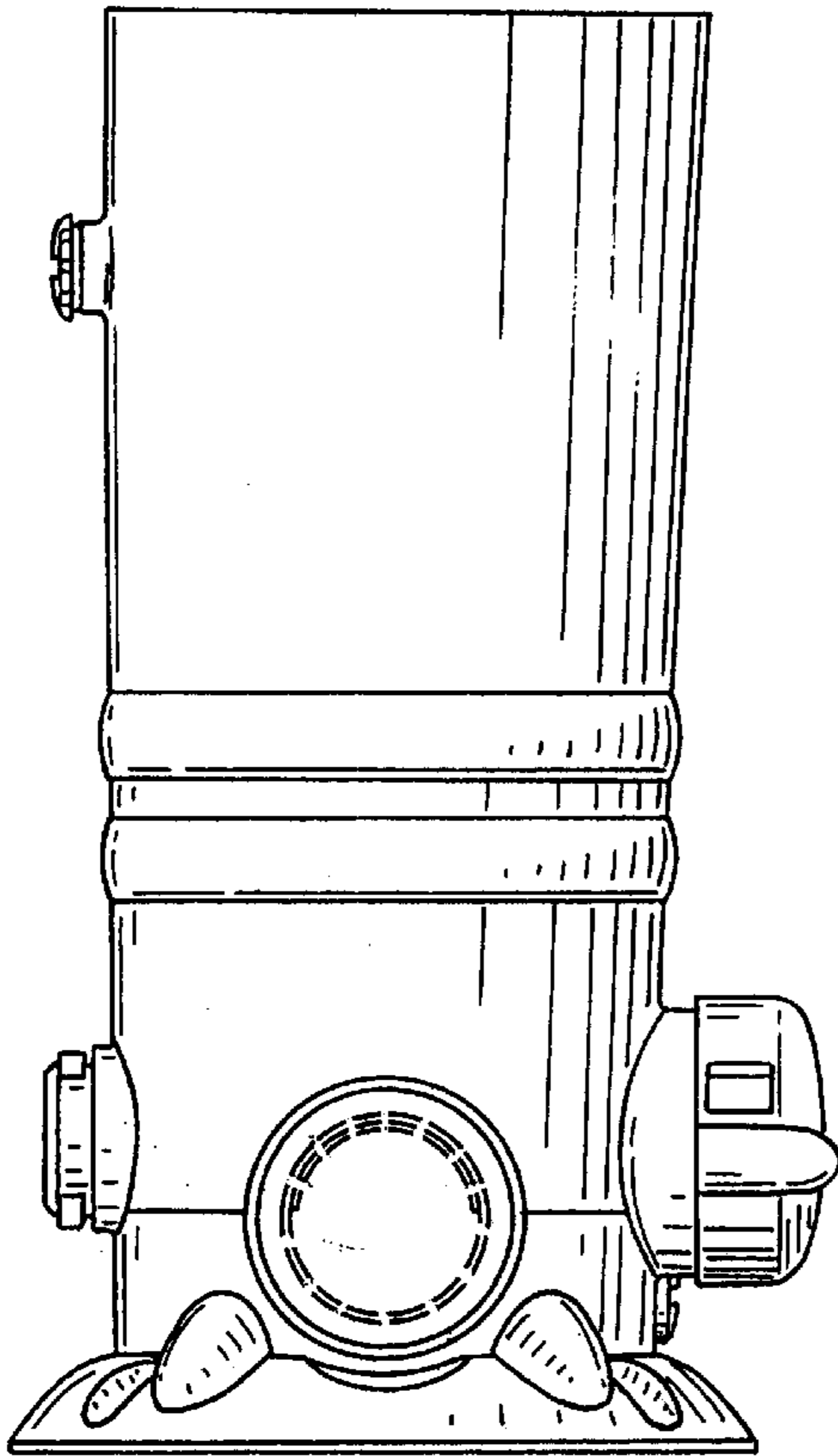

FIG. 6

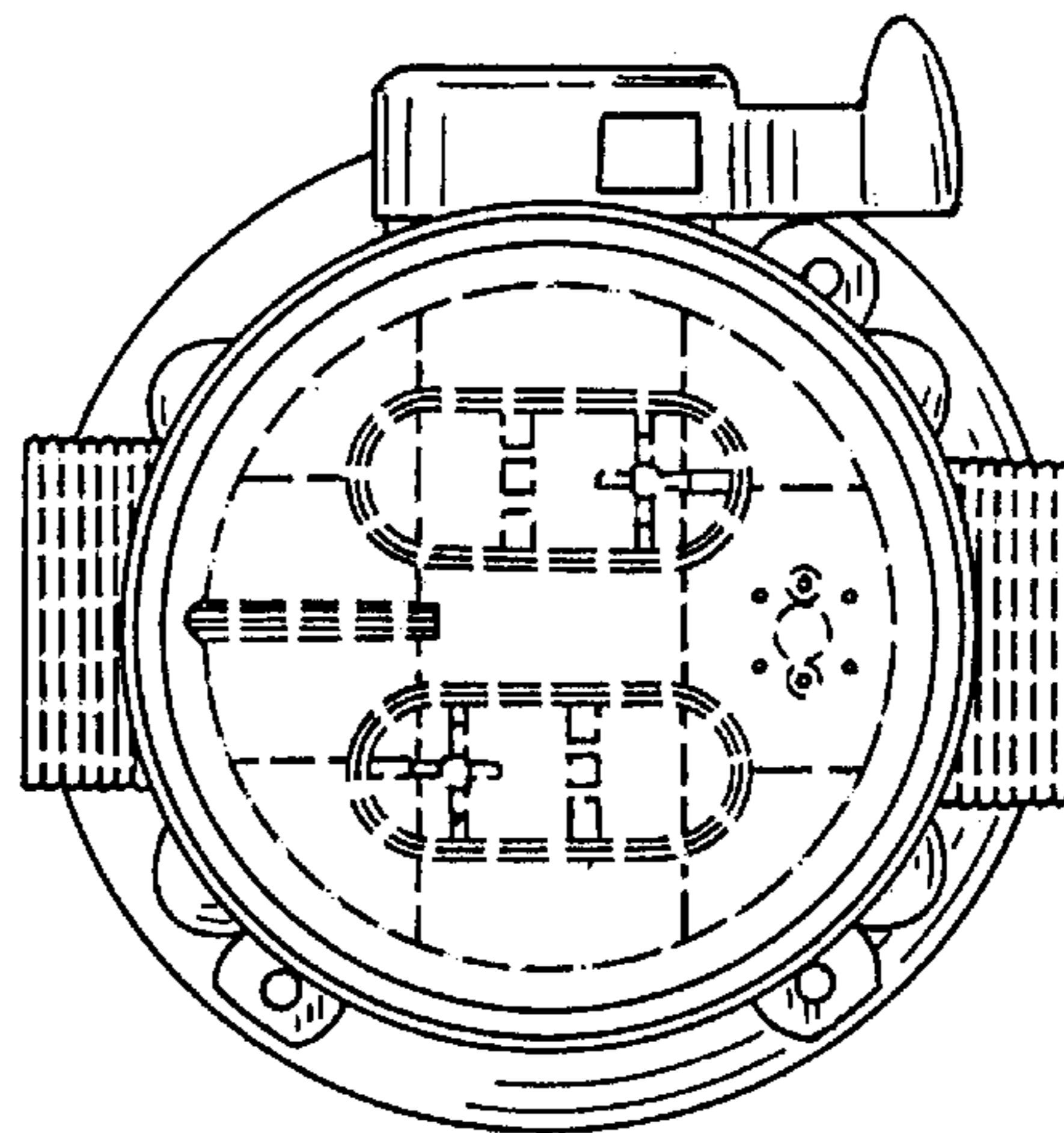

FIG. 7

