



US00D540777S

(12) **United States Design Patent**  
**Rausch et al.**

(10) **Patent No.:** **US D540,777 S**

(45) **Date of Patent:** **\*\* Apr. 17, 2007**

(54) **COMMUNICATIONS HEADSET**

(75) Inventors: **Kevin Rausch**, Aptos, CA (US); **Dale E. Thompson**, Cupertino, CA (US)

(73) Assignee: **Plantronics, Inc.**, Santa Cruz, CA (US)

(\*\*) Term: **14 Years**

(21) Appl. No.: **29/255,421**

(22) Filed: **Mar. 7, 2006**

(51) **LOC (8) Cl.** ..... **14-01**

(52) **U.S. Cl.** ..... **D14/205**

(58) **Field of Classification Search** ..... D14/142,  
D14/156, 188, 192, 205, 206, 223, 225; 379/430,  
379/433; 181/129, 130, 137; 381/381, 371,  
381/370, 376, 377, 378, 379, 380, 183, 187;  
455/565; D24/110

See application file for complete search history.

(56) **References Cited**

**U.S. PATENT DOCUMENTS**

4,597,469	A	*	7/1986	Nagashima	.....	181/129
4,689,822	A	*	8/1987	Houng	.....	381/379
D292,205	S	*	10/1987	Kikutani	.....	D14/205
D310,081	S	*	8/1990	Daido et al.	.....	D14/205
D316,861	S	*	5/1991	Yoda et al.	.....	D14/205
D328,074	S	*	7/1992	Yamazaki et al.	.....	D14/205
D338,010	S	*	8/1993	Yamatogi	.....	D14/205
D345,162	S	*	3/1994	Yamatogi	.....	D14/205

D358,388	S	*	5/1995	Nakamura et al.	.....	D14/205
D394,062	S	*	5/1998	Chun	.....	D14/192
D404,035	S	*	1/1999	Delazzer	.....	D14/206
D457,874	S	*	5/2002	Yoneda	.....	D14/205
D463,396	S	*	9/2002	Beraut et al.	.....	D14/205

\* cited by examiner

*Primary Examiner*—Paula A. Greene

(57) **CLAIM**

The ornamental design for a communications headset, as shown and described.

**DESCRIPTION**

This application is related to U.S. design patent application Ser. No. 29/255,715 filed concurrently herewith.

FIG. 1 is a lower right front perspective view of a communications headset showing our new design;

FIG. 2 is a top plan view thereof;

FIG. 3 is a bottom plan view thereof;

FIG. 4 is a right side elevation view thereof;

FIG. 5 is a left side elevation view thereof;

FIG. 6 is a front elevation view thereof;

FIG. 7 is a rear elevation view thereof; and,

FIG. 8 is an upper left front perspective view thereof.

The ornamental design that is claimed is shown in solid lines in the drawings. The broken line outline of a microphone boom is shown in the drawings for environmental purposes only, and forms no part of the claimed design.

**1 Claim, 5 Drawing Sheets**

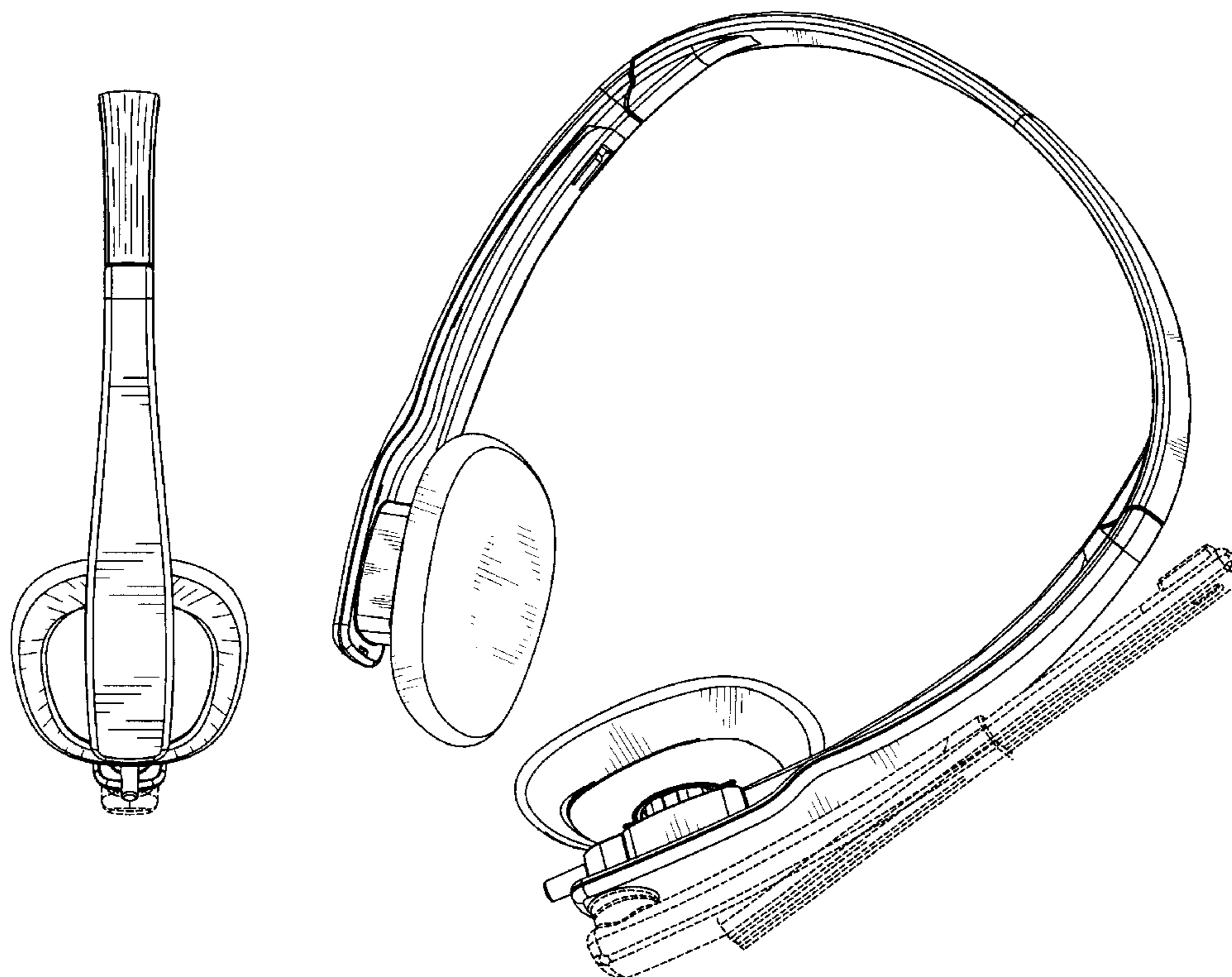
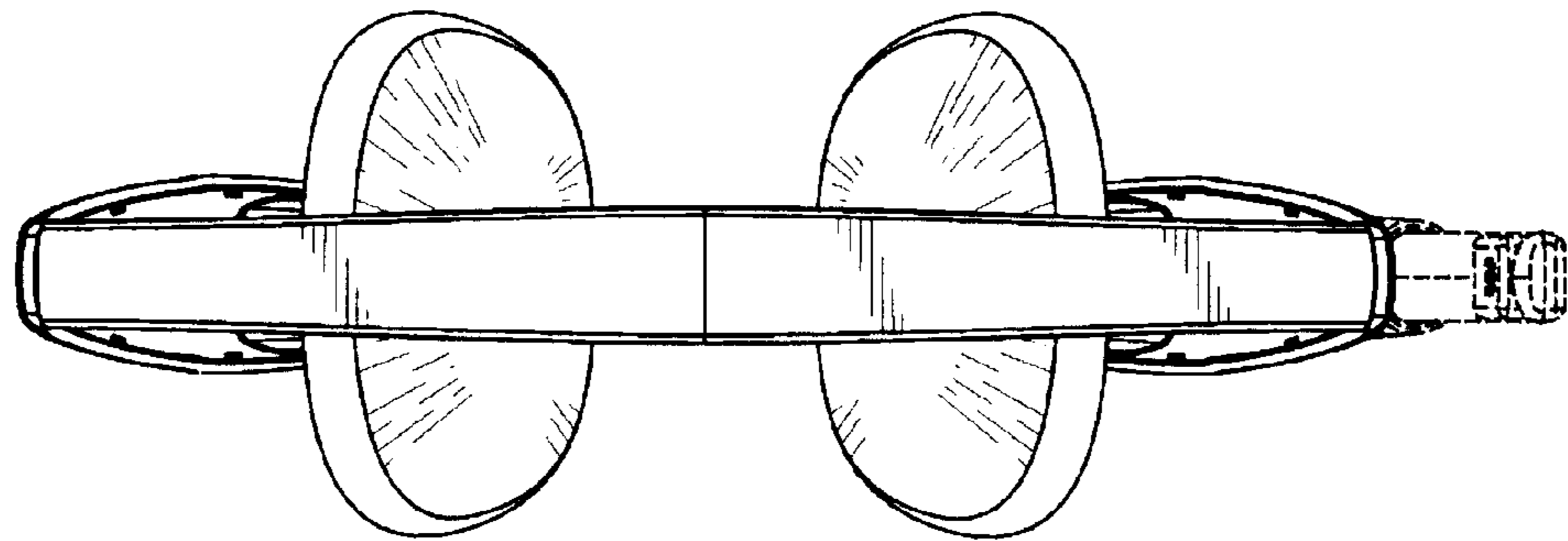
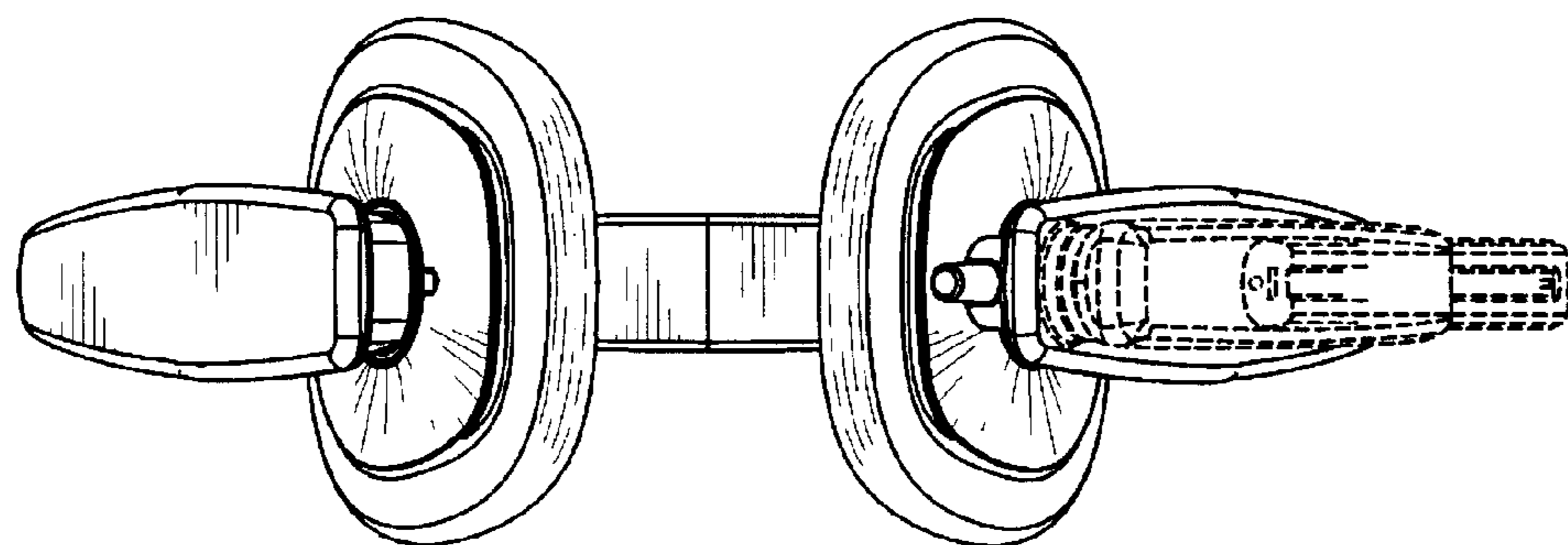



FIG. 1



**FIG. 2**



**FIG. 3**

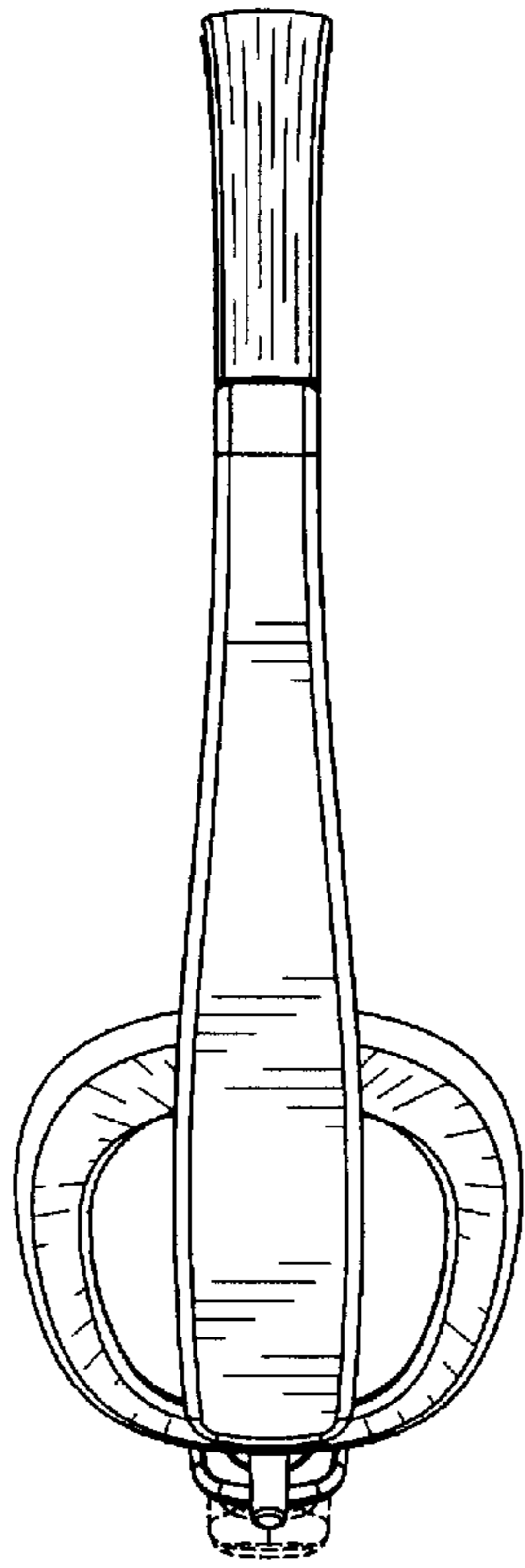

**FIG. 4**

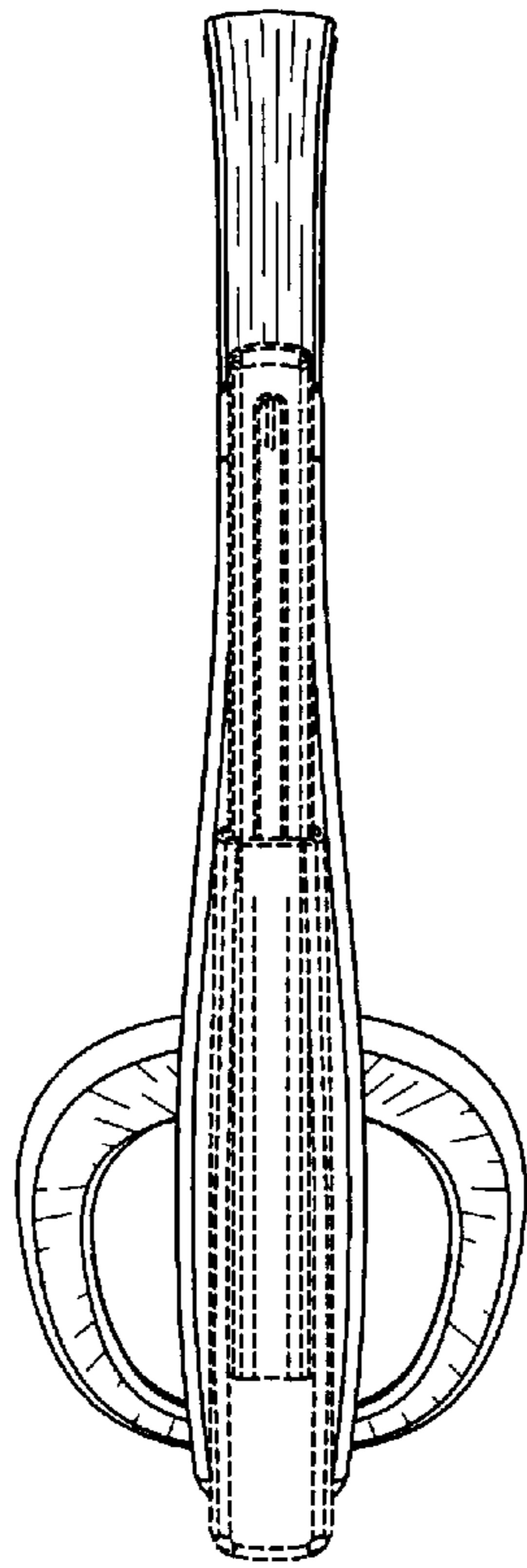

**FIG. 5**

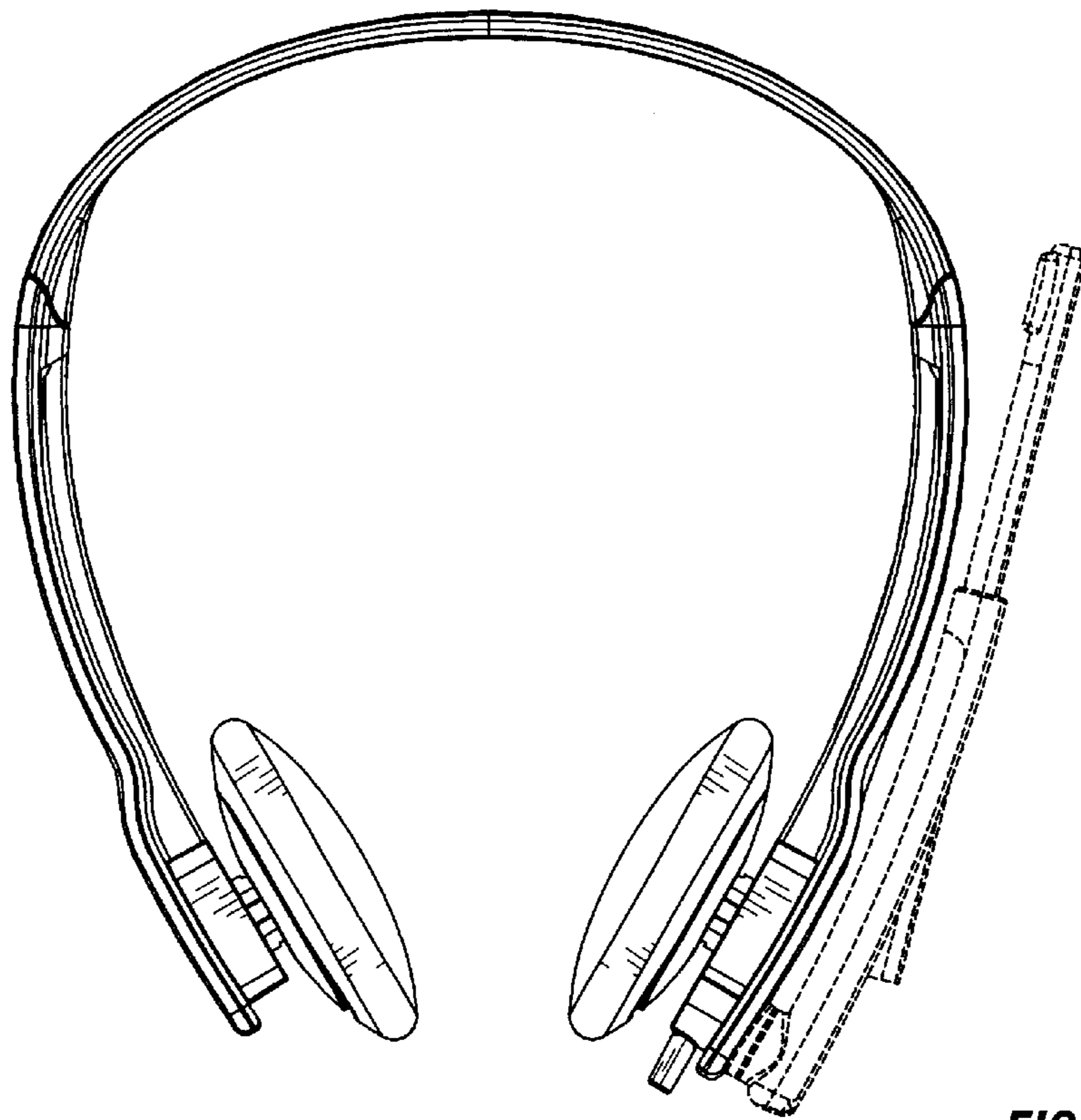

FIG. 6

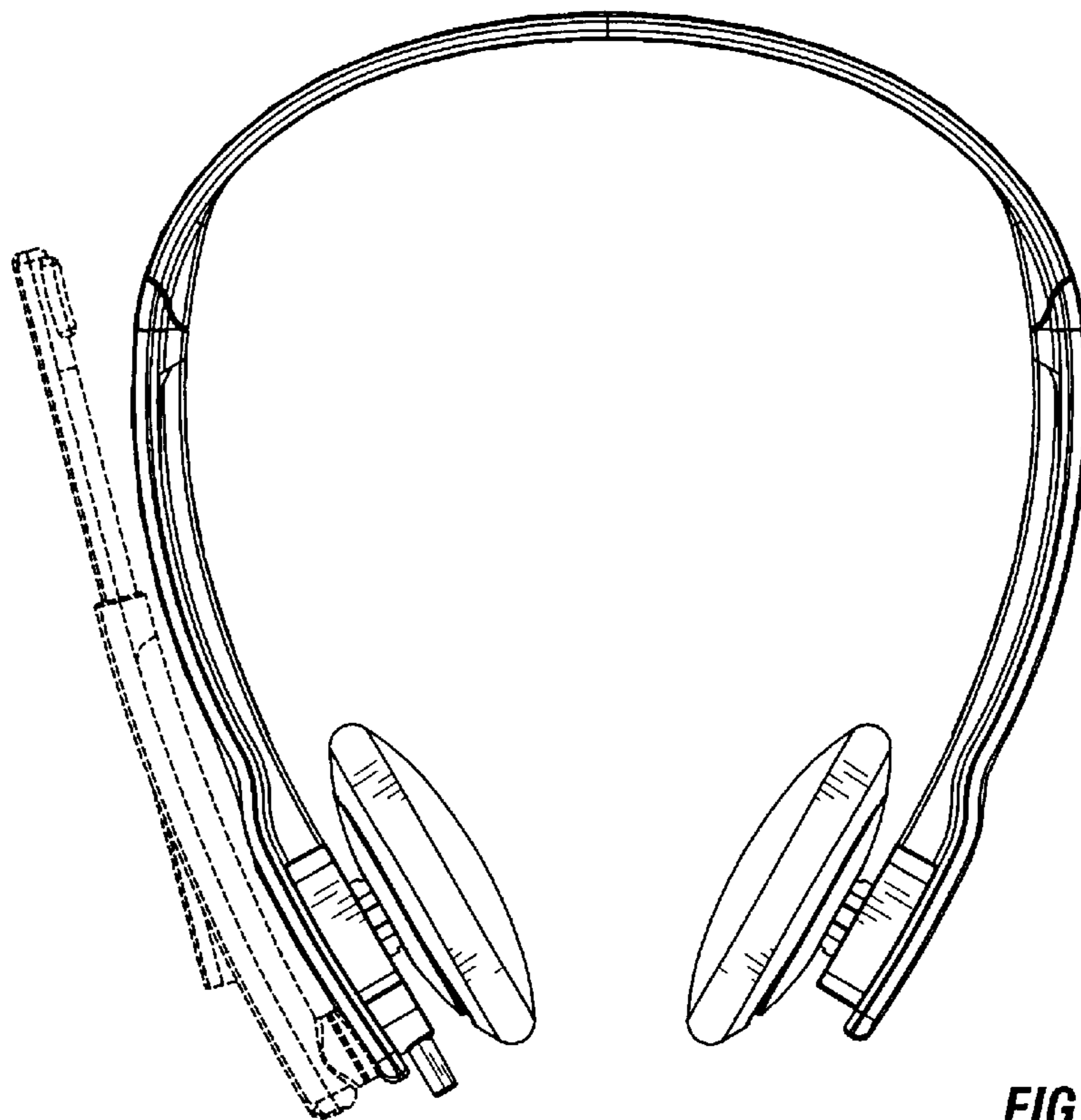

FIG. 7

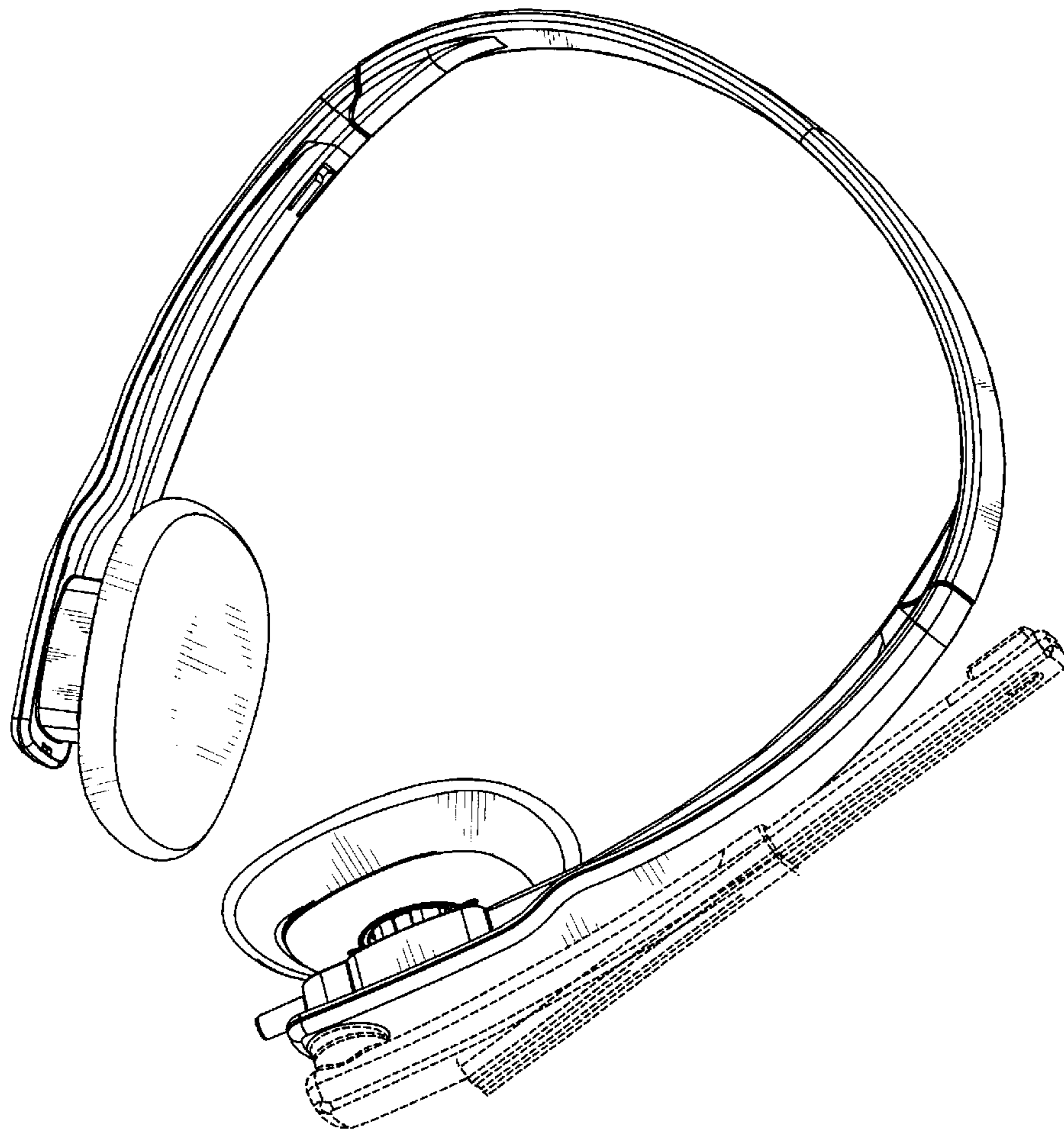

FIG. 8