

US00D540684S

(12) **United States Design Patent**
Dowel

(10) **Patent No.:** **US D540,684 S**
(45) **Date of Patent:** **** Apr. 17, 2007**

(54) **CONTAINER**

(75) Inventor: **Terence Dowel**, Clematis (AU)

(73) Assignee: **Trydel Research Pty. Ltd.**, Victoria (AU)

(**) Term: **14 Years**

(21) Appl. No.: **29/256,640**

(22) Filed: **Mar. 23, 2006**

(30) **Foreign Application Priority Data**

Sep. 23, 2005 (AU) 14131/2005

(51) **LOC (8) Cl.** **09-01**

(52) **U.S. Cl.** **D9/520**

(58) **Field of Classification Search** D9/500,
D9/502-503, 516, 520, 537-539, 549, 556-558,
D9/723-724; 215/370-379, 381-384; 220/605,
220/660, 662, 669, 675

See application file for complete search history.

(56) **References Cited**

U.S. PATENT DOCUMENTS

5,133,468 A * 7/1992 Brunson et al. 215/375
5,529,196 A * 6/1996 Lane 215/375
5,549,210 A * 8/1996 Cheng 215/375
5,756,018 A * 5/1998 Valyi 264/40.1
D417,392 S * 12/1999 Zhang D9/434

FOREIGN PATENT DOCUMENTS

GB 2055995 * 8/1996

* cited by examiner

Primary Examiner—Ian Simmons

Assistant Examiner—Anna Burmeister

(74) *Attorney, Agent, or Firm*—Meyertons, Hood, Kivlin,
Kowert & Goetzel, P.C.; Eric B. Meyertons

(57) **CLAIM**

The ornamental design for a container, as shown and described.

DESCRIPTION

FIG. 1 is a perspective view of a container that emphasizes the front of the container.

FIG. 2 is a perspective view of the container that emphasizes the bottom of the container.

FIG. 3 is a top view of the container.

FIG. 4 is a bottom view of the container.

FIG. 5 is a view of the container as viewed along arrow 5 depicted in FIG. 4.

FIG. 6 is a view of the container as viewed along arrow 6 depicted in FIG. 4.

FIG. 7 is a view of the container as viewed along arrow 7 depicted in FIG. 4; and,

FIG. 8 is a view of the container as viewed along arrow 8 depicted in FIG. 4.

The broken lines in the drawings are for illustrative purposes only and form no part of the claimed design.

1 Claim, 4 Drawing Sheets

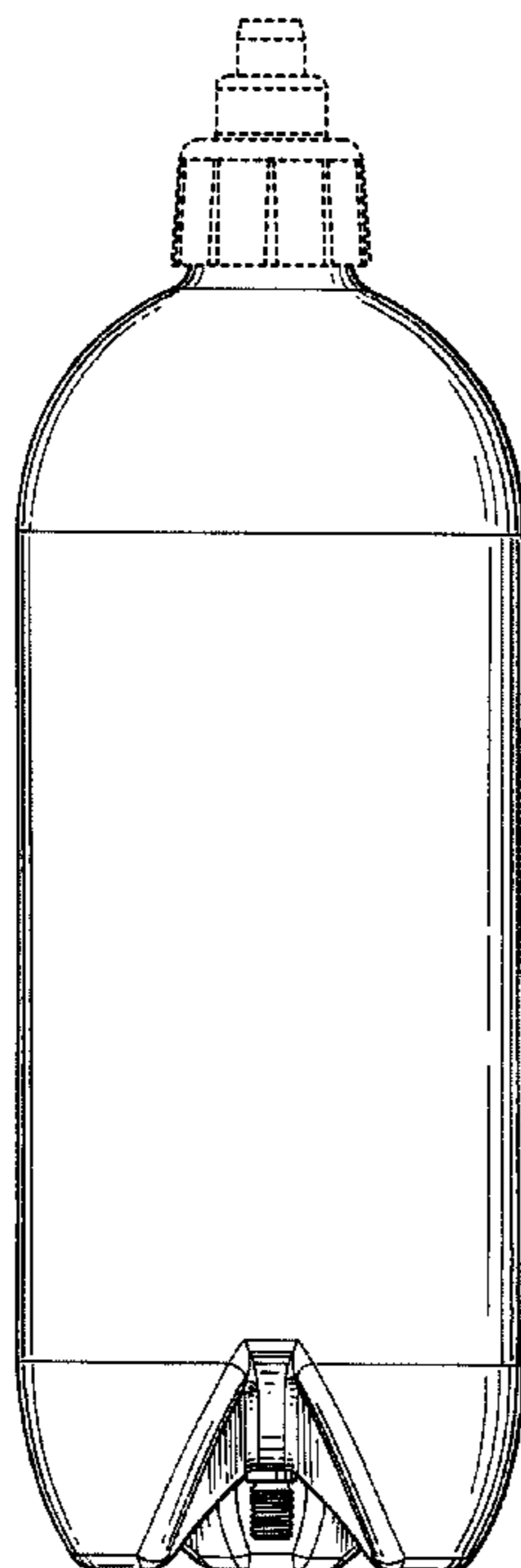

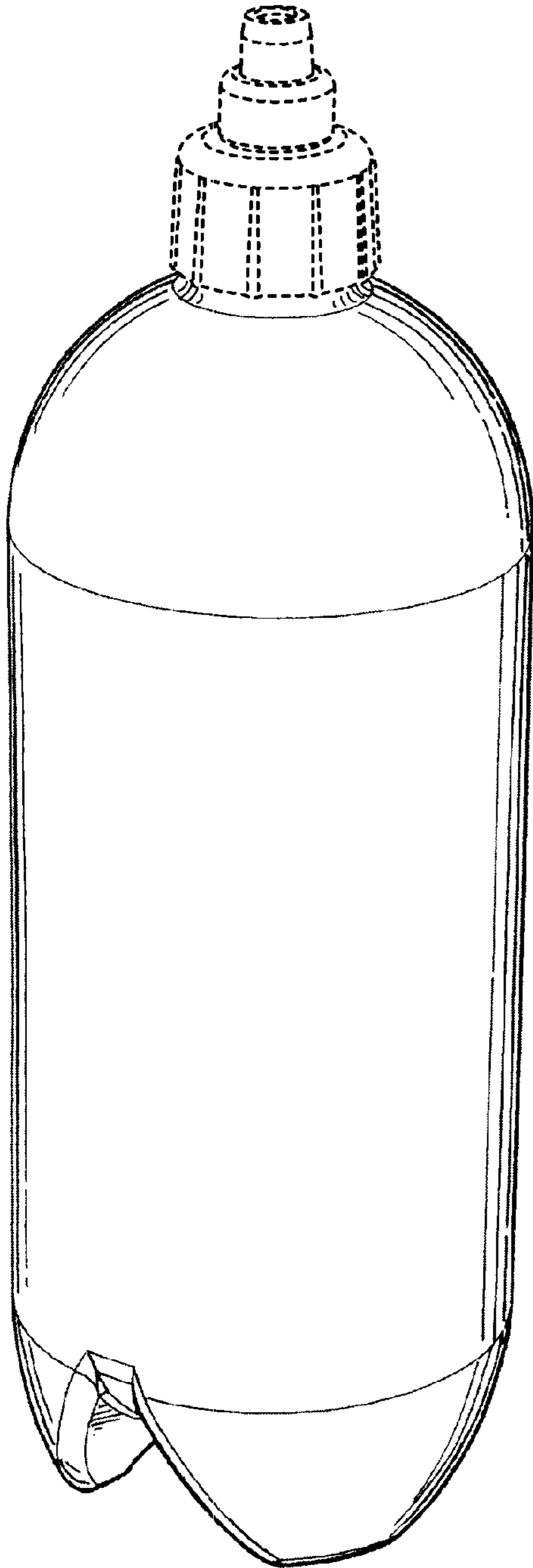

Fig. 1

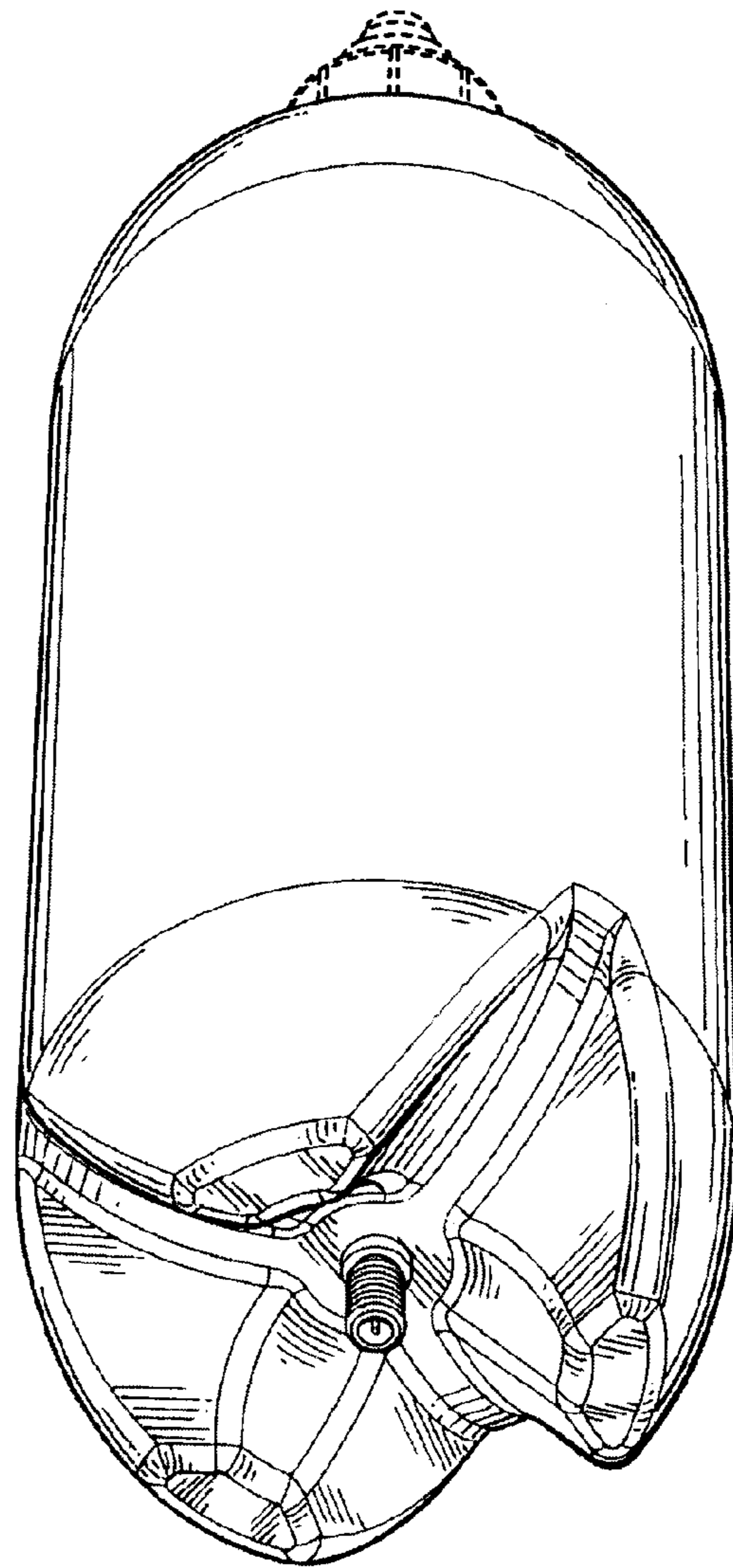

Fig. 2

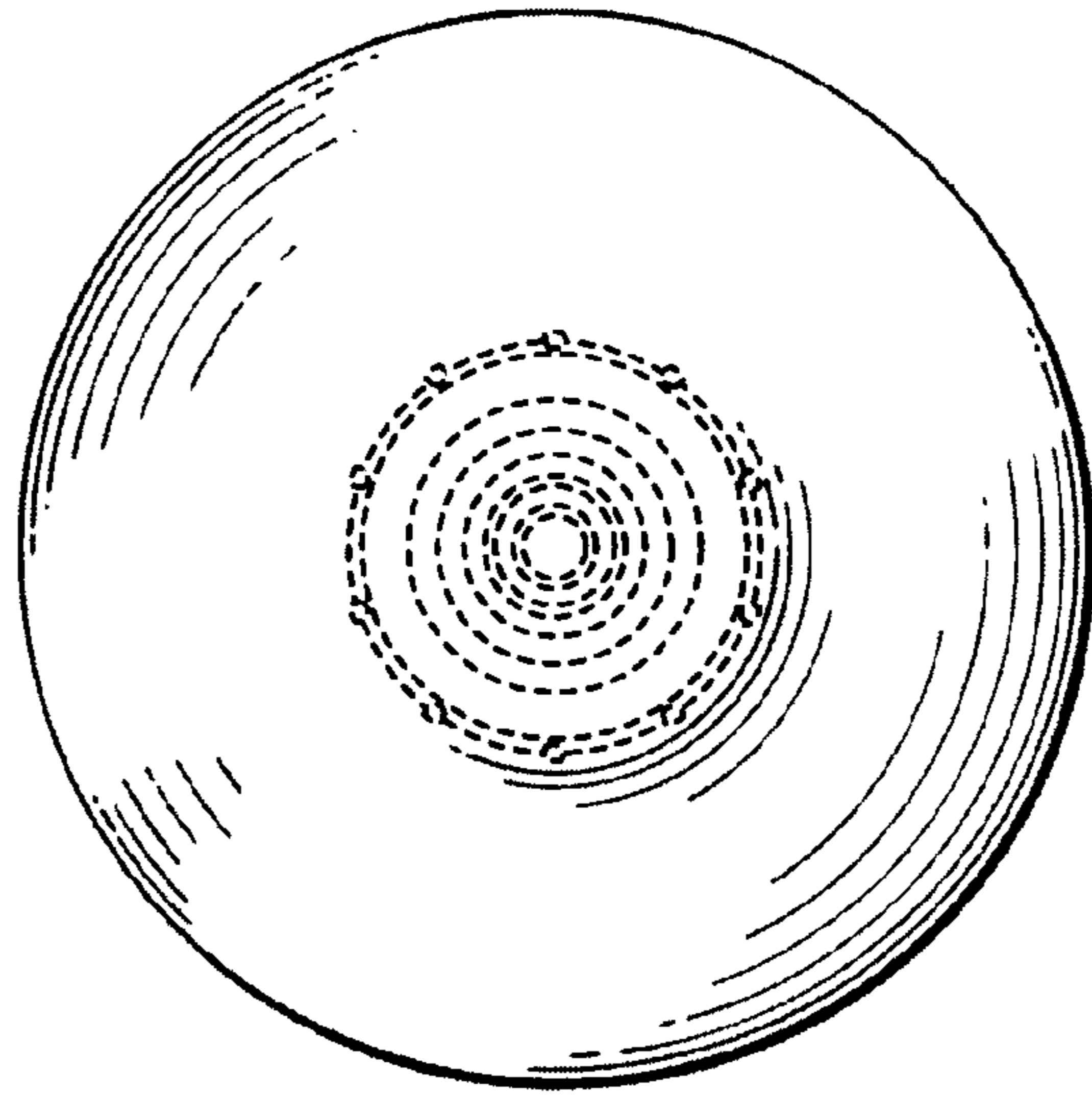

Fig. 3

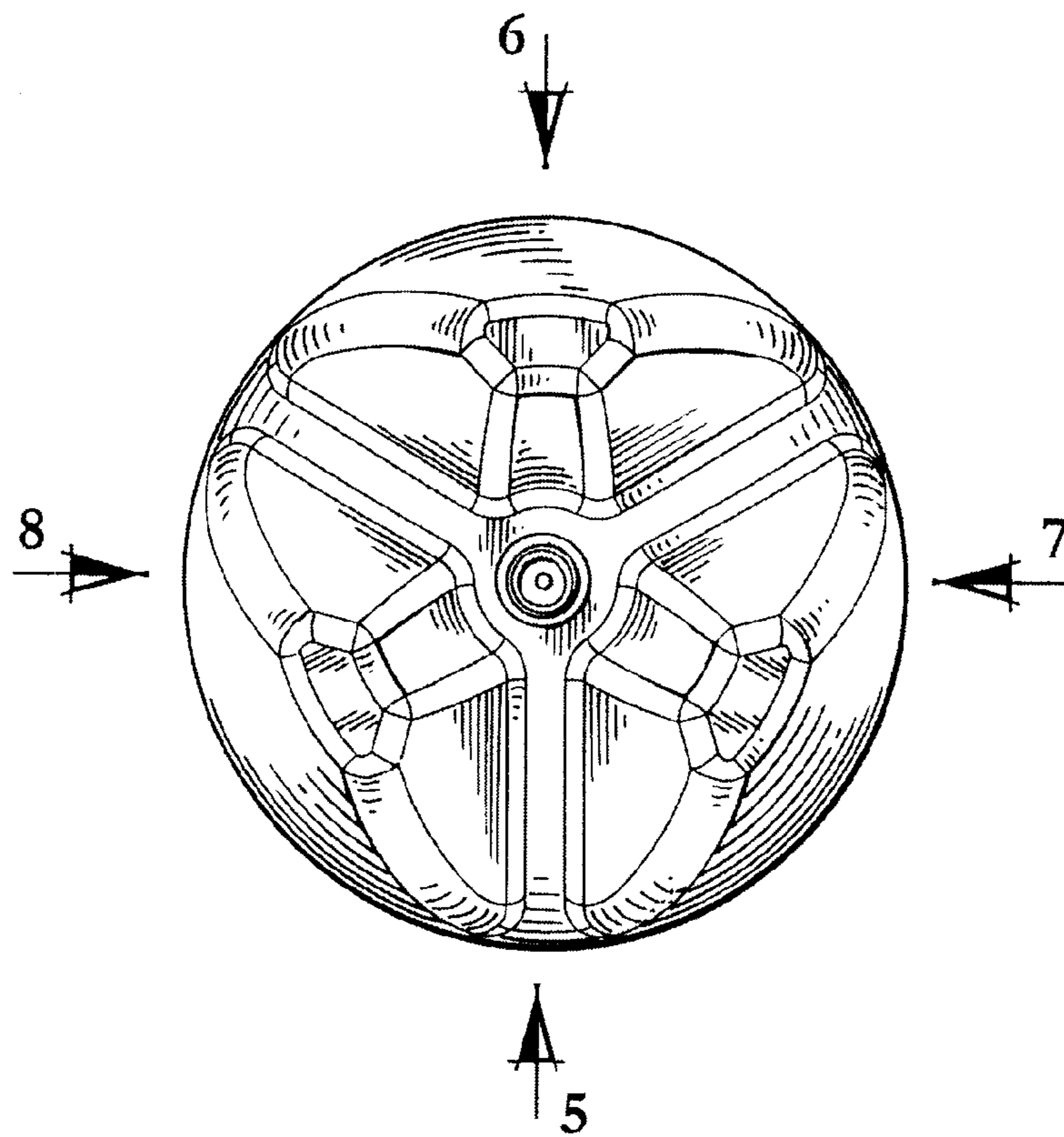

Fig. 4

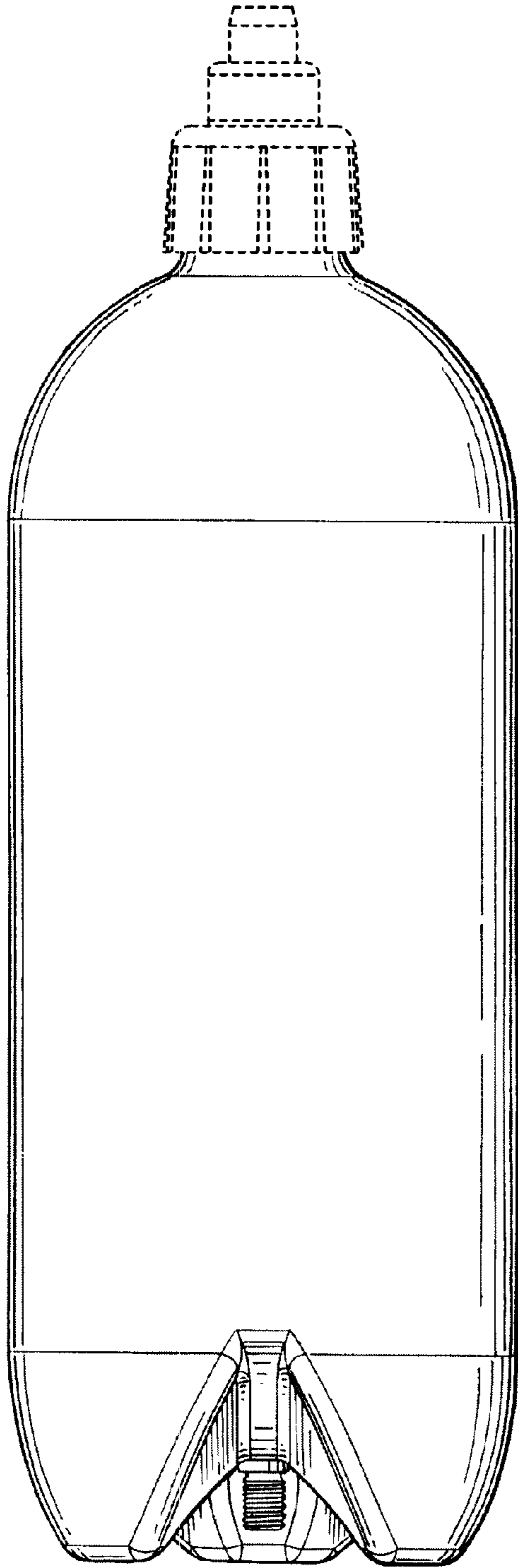

Fig. 5

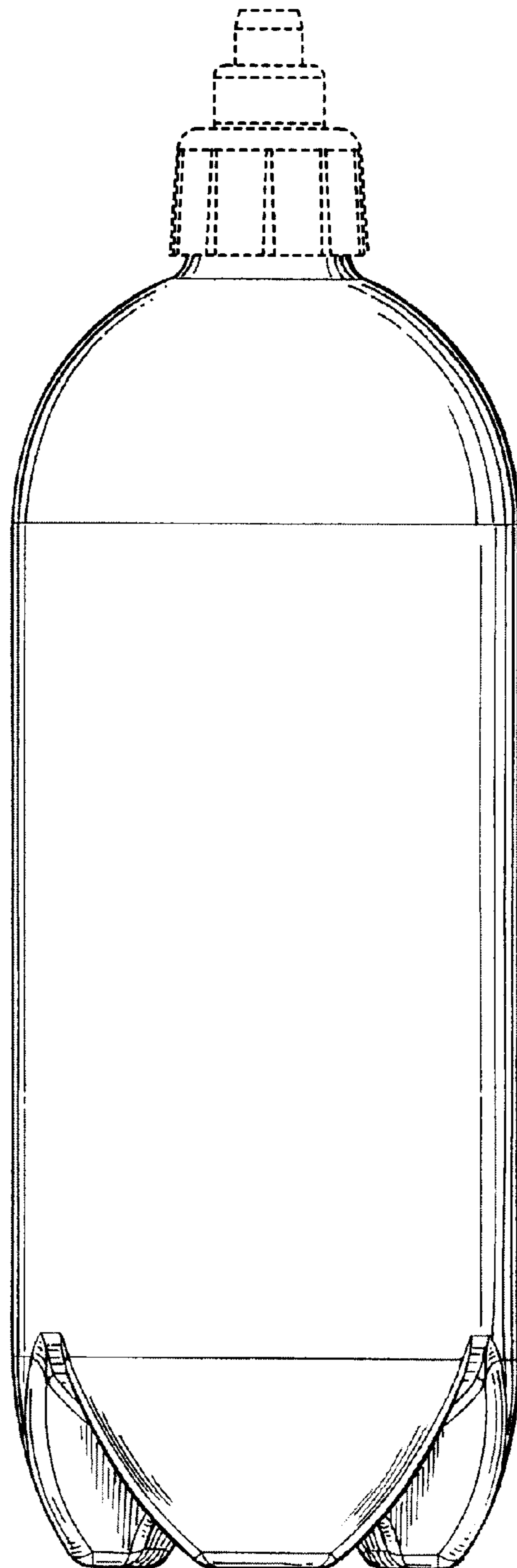

Fig. 6

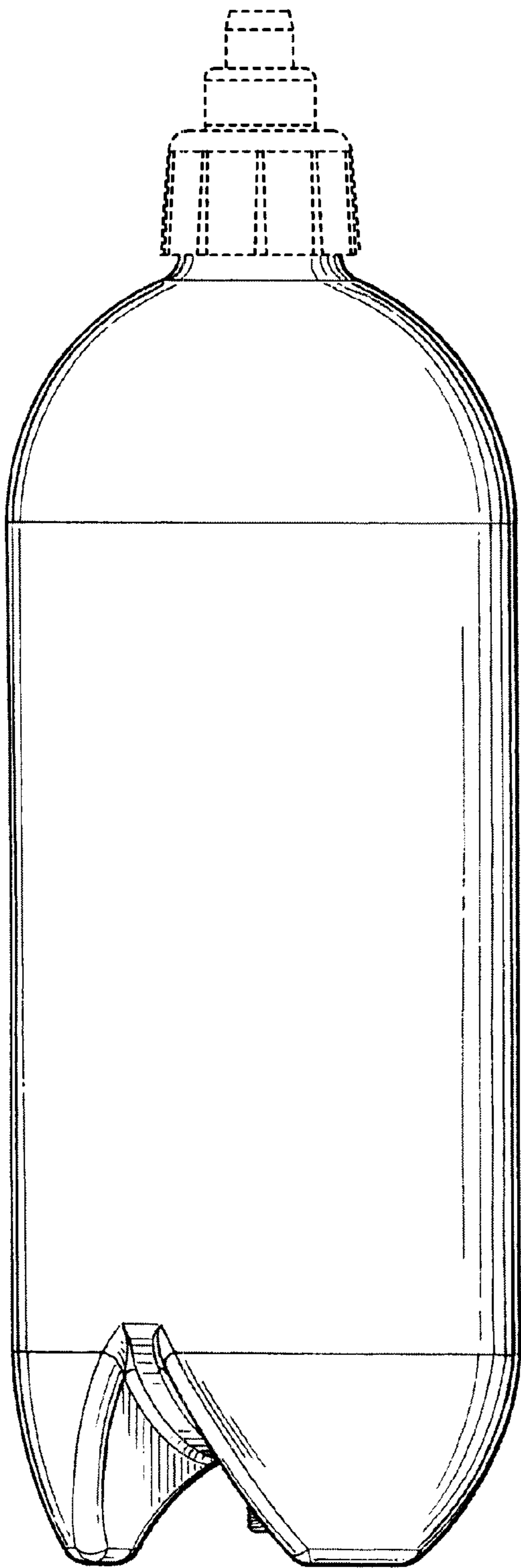

Fig. 7

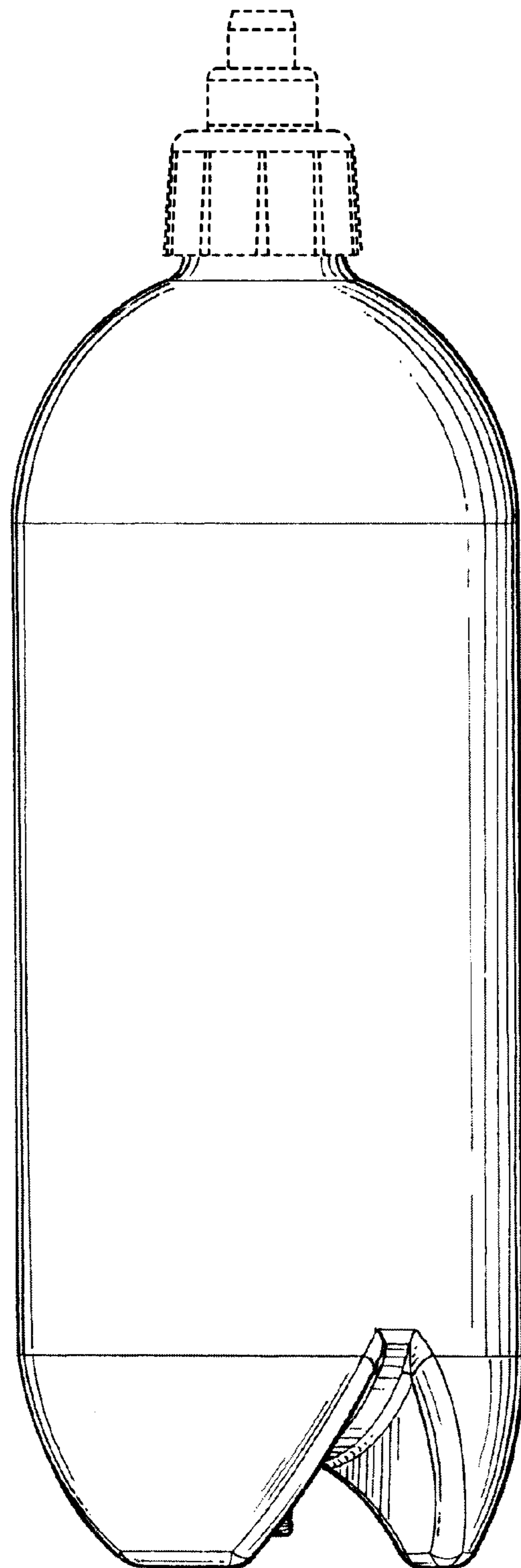

Fig. 8