

US00D540668S

(12) **United States Design Patent**
Aldridge

(10) **Patent No.:** **US D540,668 S**

(45) **Date of Patent:** **** Apr. 17, 2007**

(54) **COVER FLAP FOR CONFECTIONARY
PRODUCT CONTAINER**

(75) Inventor: **Allen S. Aldridge**, South Orange, NJ
(US)

(73) Assignee: **Cadbury Adams USA, LLC**,
Parsippany, NJ (US)

(**) Term: **14 Years**

(21) Appl. No.: **29/208,688**

(22) Filed: **Jul. 1, 2004**

(51) **LOC (8) Cl.** **09-07**

(52) **U.S. Cl.** **D9/434**

(58) **Field of Classification Search** D9/434,
D9/433, 432; 220/528; 229/117.16, 117.9,
229/117.17, 103, 103.3, 116.1, 5.5, 906, 122
See application file for complete search history.

(56) **References Cited**

U.S. PATENT DOCUMENTS

183,466 A 10/1876 Pearl 131/366
276,171 A 4/1883 Fraser 229/120.09

(Continued)

FOREIGN PATENT DOCUMENTS

JP HEI 11 (1999)-1220 1/1999
JP HEI 11 (1999)-1221 1/1999
WO WO 01/07335 2/2001

OTHER PUBLICATIONS

New Product Alert Document—"Mr. Brown Chewing Gum"
Feb. 7, 2000.

Primary Examiner—Robert M. Spear

Assistant Examiner—Susan Bennett Hattan

(74) *Attorney, Agent, or Firm*—Robert G. Crouch; Marsh
Fischmann and Breyfogle, LLP

(57) **CLAIM**

The ornamental design for a cover flap for confectionary product container, as shown and described.

DESCRIPTION

FIG. 1 is a front elevation view of the confectionary product container showing the cover flap, those portions of the confectionary product container shown in phantom are not part of the design sought to be patented and are provided for environmental purposes only;

FIG. 2 is a top plan view of the container;

FIG. 3 is a bottom plan view of the container;

FIG. 4 is a right side elevation view of the container;

FIG. 5 is a left side elevation view of the container;

FIG. 6 is a rear elevation view of the container;

FIG. 7 is a perspective view of the container;

FIG. 8 is a front elevation view of a second embodiment of the confectionary product container showing the cover flap, the second embodiment being a mirror image of the embodiment shown in FIGS. 1–7, those portions of the confectionary product container shown in phantom are not part of the design sought to be patented and are provided for environmental purposes only;

FIG. 9 is a top plan view of the second embodiment of the container;

FIG. 10 is a bottom plan view of the second embodiment of the container;

FIG. 11 is a right side elevation view of the second embodiment of the container;

FIG. 12 is a left side elevation view of the second embodiment of the container;

FIG. 13 is a rear elevation view of the second embodiment of the container; and,

FIG. 14 is a perspective view of the second embodiment of the container.

1 Claim, 4 Drawing Sheets

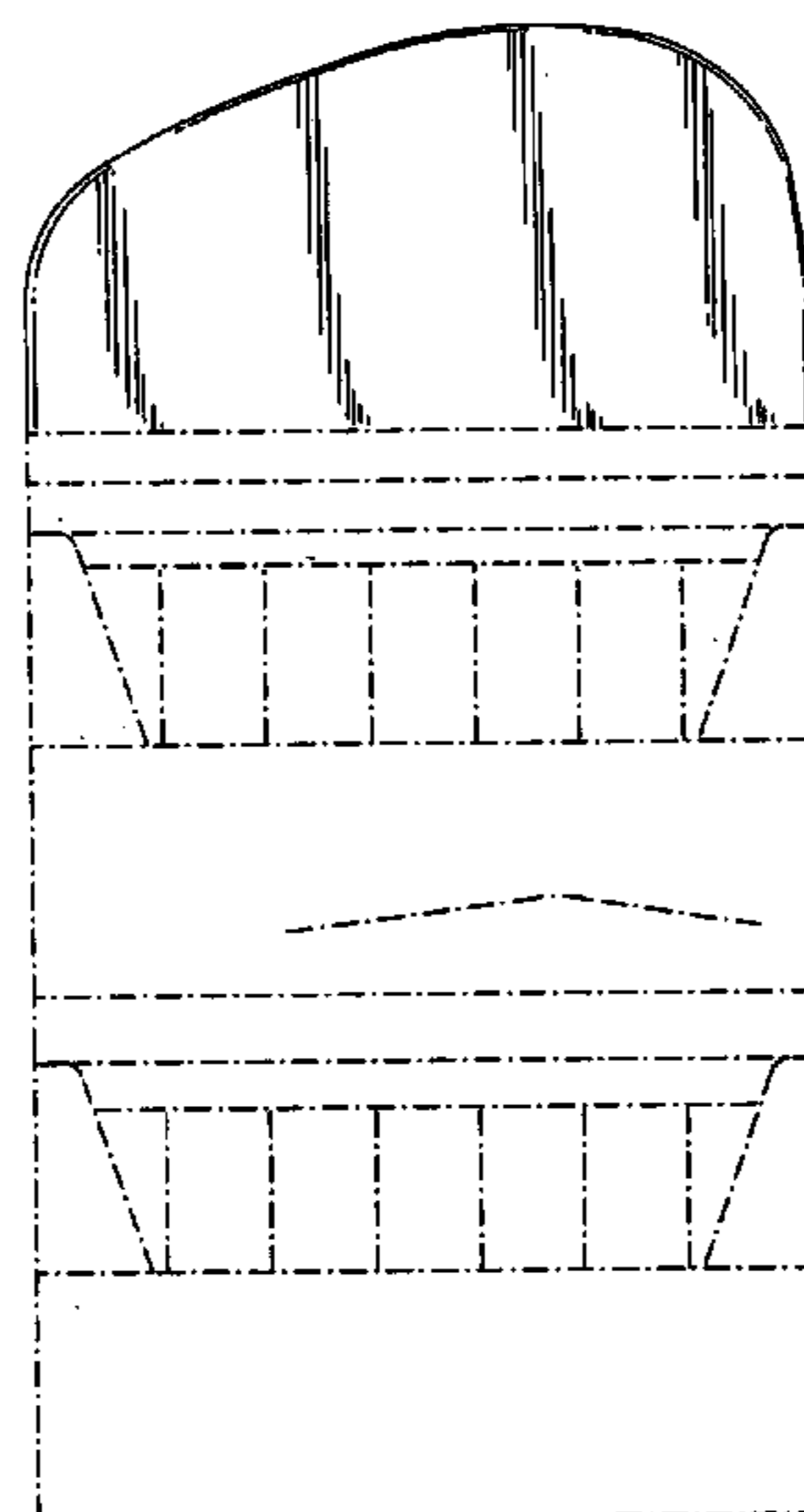

US D540,668 S

U.S. PATENT DOCUMENTS

329,134 A	10/1885	Brotz	229/149	3,035,756 A	5/1962	Mullinix	229/87.11
603,872 A	5/1898	Bucklin	206/256	3,039,671 A	6/1962	Chiamardas	229/27
624,583 A	5/1899	Vierengel	229/149	3,093,292 A	6/1963	Ahlbor	206/264
640,541 A *	1/1900	Danzenbaker	229/122	3,201,258 A	8/1965	Mastella	99/180
1,216,259 A	2/1917	Armstrong	206/499	3,472,362 A	10/1969	Shindo	206/41.4
1,256,965 A	2/1918	Williams	206/256	3,509,989 A	5/1970	Woll	206/94
1,432,932 A	10/1922	Weis		3,680,766 A	8/1972	Collura et al.	229/51
1,433,439 A	10/1922	Weis	229/149	3,710,977 A	1/1973	Van Den Enden et al.	221/102
1,469,080 A	9/1923	Goerk		3,734,801 A	5/1973	Sebel	156/152
1,550,966 A	8/1925	Kappes	426/5	3,881,649 A	5/1975	Krautsack	229/117.12
1,575,420 A	3/1926	Eisenstark	69/21	4,294,353 A	10/1981	Focke	206/273
1,589,118 A	6/1926	Cowen	206/273	4,360,106 A	11/1982	Irvine	229/212
1,662,028 A	3/1928	Gold et al.		4,465,208 A	8/1984	Buban et al.	221/279
1,666,095 A	4/1928	Jackson	221/232	4,631,900 A	12/1986	Mattei et al.	
1,751,208 A	3/1930	Kappes	426/5	4,949,841 A	8/1990	Focke	206/254
1,763,763 A	6/1930	Denmead	206/96	5,029,712 A	7/1991	O'Brien	229/87.05
1,824,491 A	9/1931	Molins		5,036,983 A *	8/1991	Thykeson	229/122
1,842,891 A	1/1932	Allen	221/103	5,096,113 A	3/1992	Focke	229/87.05
1,854,849 A	4/1932	Lerch	206/100	5,123,589 A	6/1992	Cote	229/232
1,863,190 A	6/1932	Coulapides	206/256	5,125,211 A	6/1992	O'Brien	53/412
1,865,535 A	7/1932	Meany	426/5	5,248,508 A	9/1993	Reed et al.	426/5
1,866,323 A	7/1932	Russell	206/750	5,270,061 A	12/1993	Reed et al.	426/5
1,875,196 A	8/1932	Molins		5,353,956 A	10/1994	Wilson	221/198
1,875,197 A	8/1932	Molins	206/256	5,370,219 A	12/1994	Violet, Jr.	206/38
1,883,852 A	10/1932	Medoff	206/449	5,376,388 A	12/1994	Meyers	426/5
1,895,233 A	1/1933	Rossen	206/457	5,462,223 A	10/1995	Focke	229/160.1
1,903,742 A	5/1933	Coulapides	206/256	5,510,124 A	4/1996	Kopecky et al.	426/5
1,929,148 A	10/1933	Molins	206/256	5,511,658 A	4/1996	Focke	206/271
1,943,204 A	1/1934	Chute	206/41	5,556,026 A	9/1996	Blankitny	229/123.1
2,046,468 A	7/1936	Ringler		5,632,378 A	5/1997	Provost	206/460
2,074,451 A	3/1937	Berberian	229/27	5,797,494 A	8/1998	Balling et al.	206/460
2,117,281 A	5/1938	Bravi	53/395	D402,554 S *	12/1998	Batchelor	D9/433
2,192,472 A	3/1940	Huston	206/46	5,842,631 A *	12/1998	Berger	229/906
2,192,473 A	3/1940	Huston	206/46	5,885,630 A	3/1999	Zurawski et al.	426/5
2,201,956 A	5/1940	Little	426/123	5,924,625 A *	7/1999	Klein et al.	229/103.3
2,210,194 A	8/1940	Baldwin	99/180	6,001,397 A	12/1999	Boyd et al.	426/5
2,210,195 A	8/1940	Baldwin	99/180	6,010,724 A	1/2000	Boyd et al.	426/5
2,210,196 A	8/1940	Baldwin	99/180	6,164,444 A	12/2000	Bray	206/268
2,263,191 A	11/1941	Saladin et al.	205/56	6,199,687 B1	3/2001	Tambo	206/268
2,316,796 A	4/1943	Lichter	221/63	6,220,430 B1	4/2001	Boriani	206/229
2,319,560 A	5/1943	Salfisberg		6,237,760 B1	5/2001	Parker	206/273
2,339,656 A	1/1944	Shina	229/44	D465,416 S	11/2002	Dzwill	D9/432
2,349,589 A *	5/1944	Harrington	229/115	6,478,149 B1	11/2002	Parker	206/273
2,353,761 A	7/1944	Ringler	229/7	D479,464 S	9/2003	Kopecky	D9/432
2,380,367 A	7/1945	Ranney	426/5	D484,046 S *	12/2003	Kopecky	D9/432
2,514,255 A	7/1950	Piazzze	206/48.5	D484,798 S *	1/2004	Bukowski	D9/433
2,577,007 A *	12/1951	Dubilier	229/122	D489,255 S *	5/2004	Kratzert et al.	D9/433
D170,974 S *	12/1953	Gorham	D9/433	D494,467 S *	8/2004	Ohno	D9/433
2,988,209 A	6/1961	Parrilla	206/56	2003/0080020 A1	5/2003	Kopecky	206/526

* cited by examiner

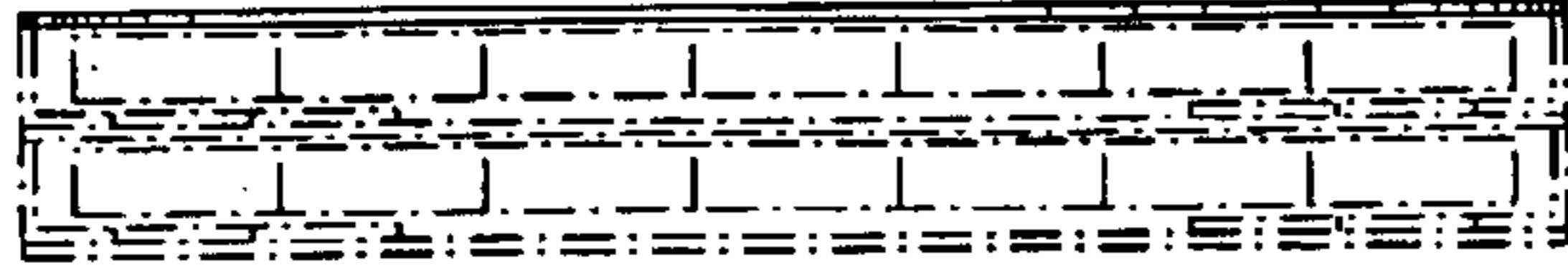

FIG. 2

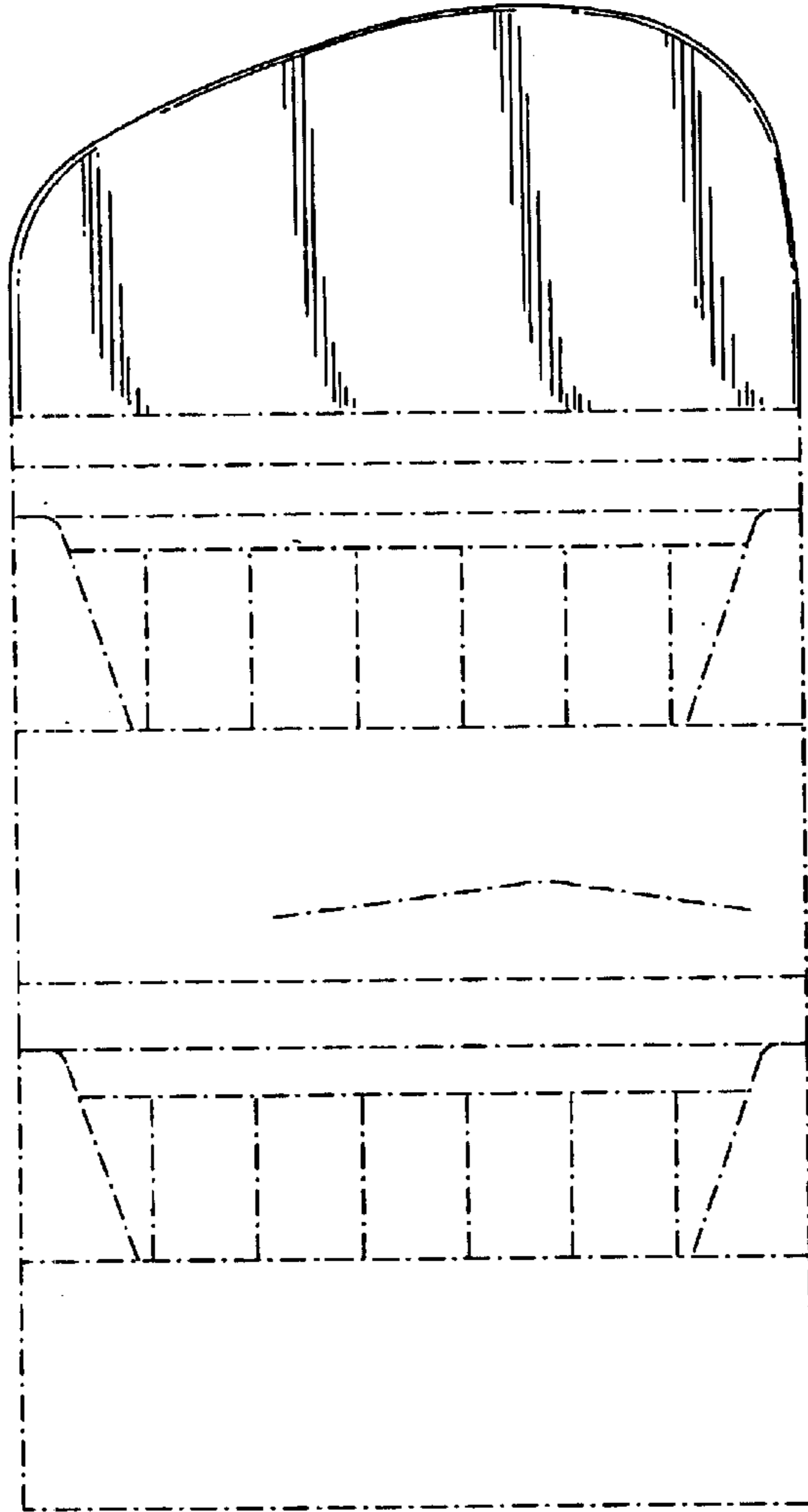

FIG. 1

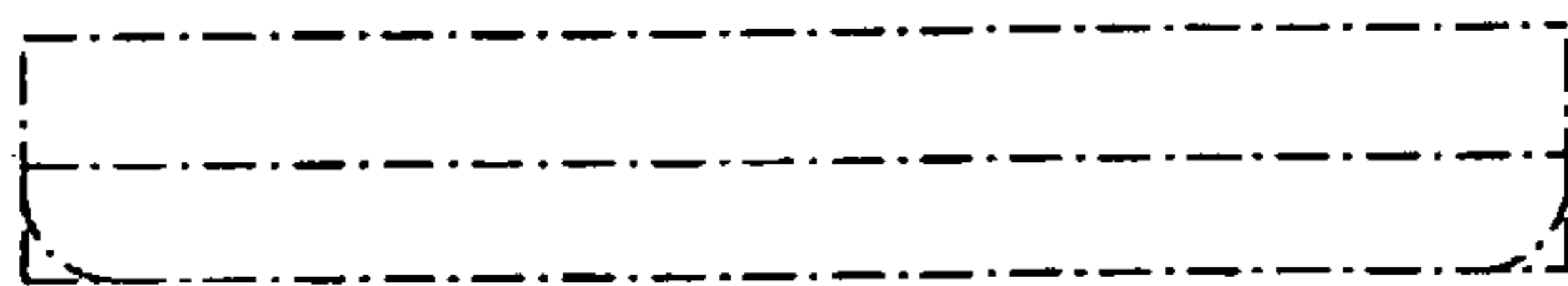

FIG. 3

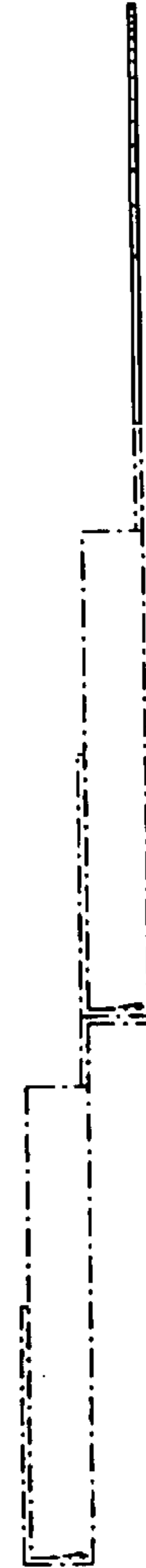

FIG. 4

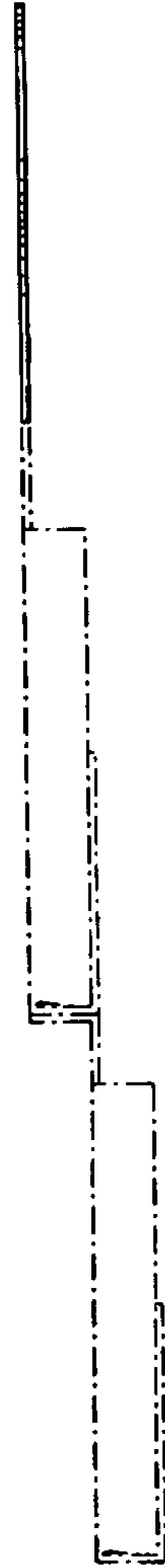

FIG. 5

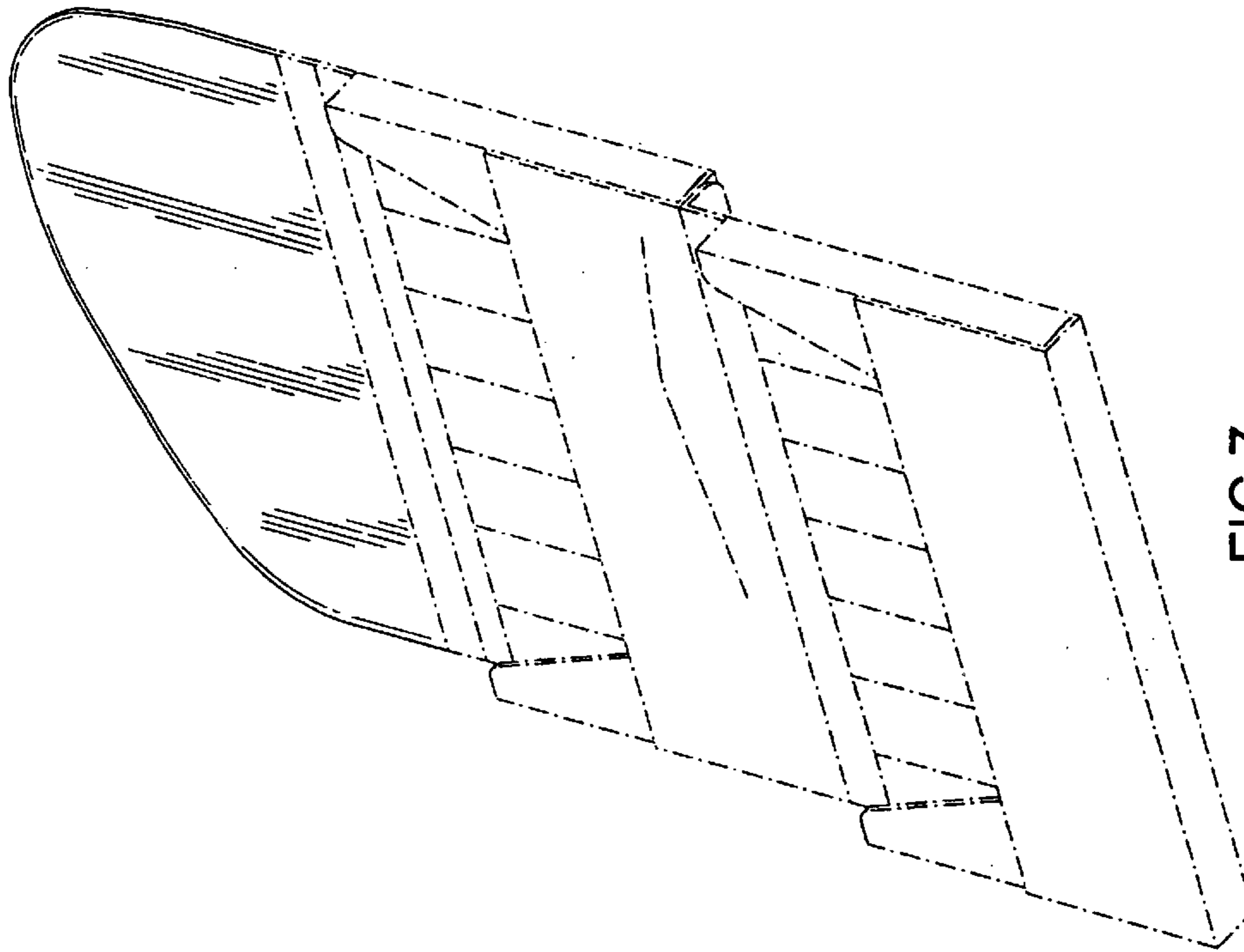

FIG. 7

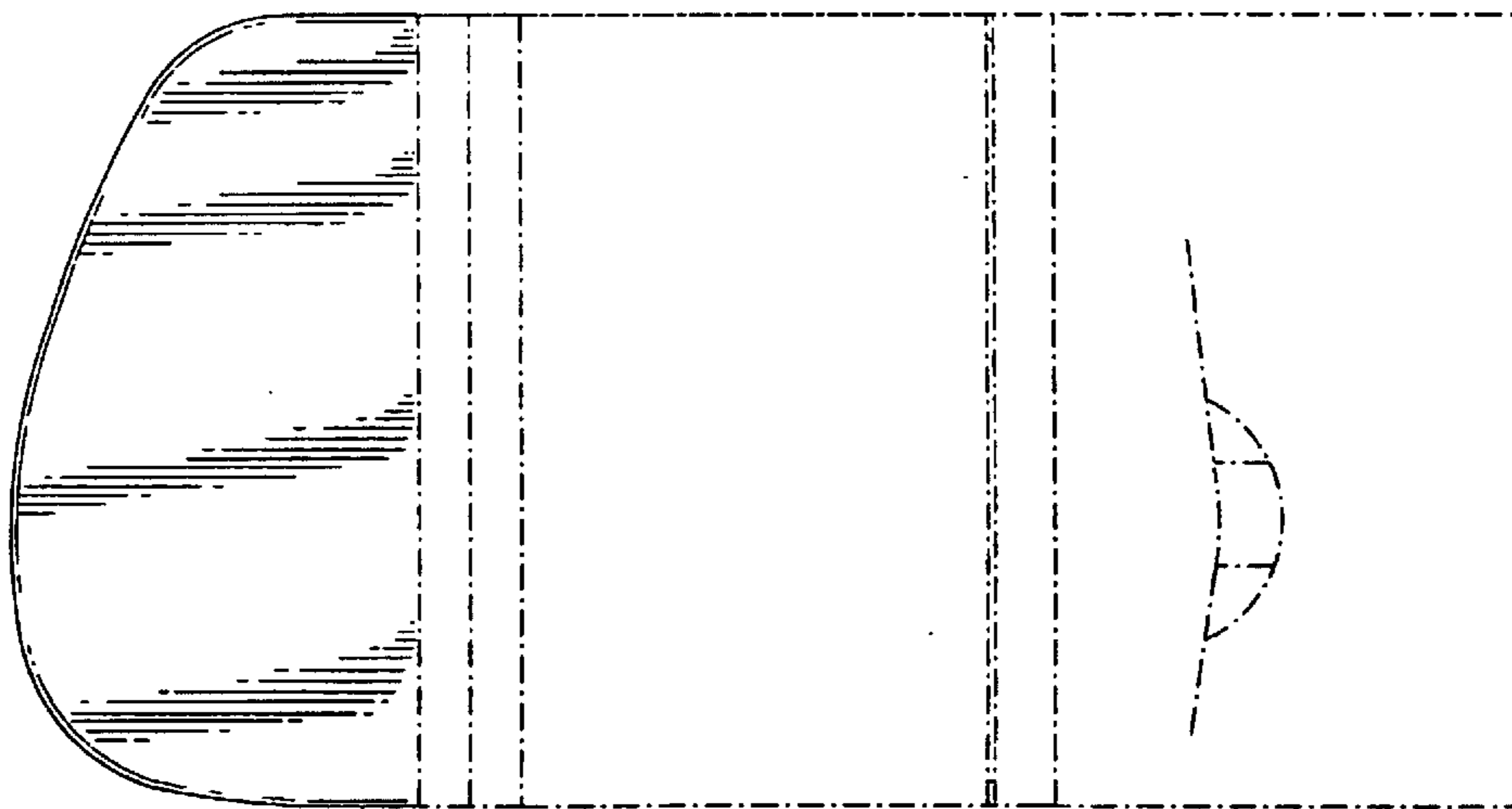

FIG. 6

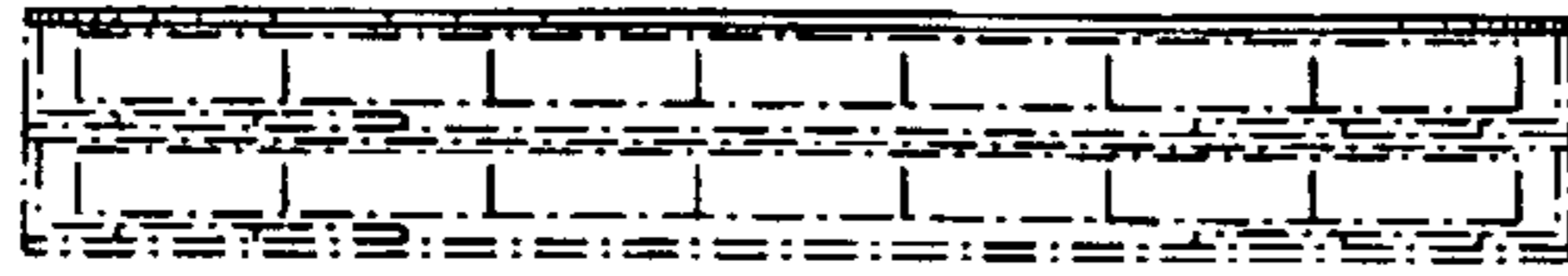

FIG. 9

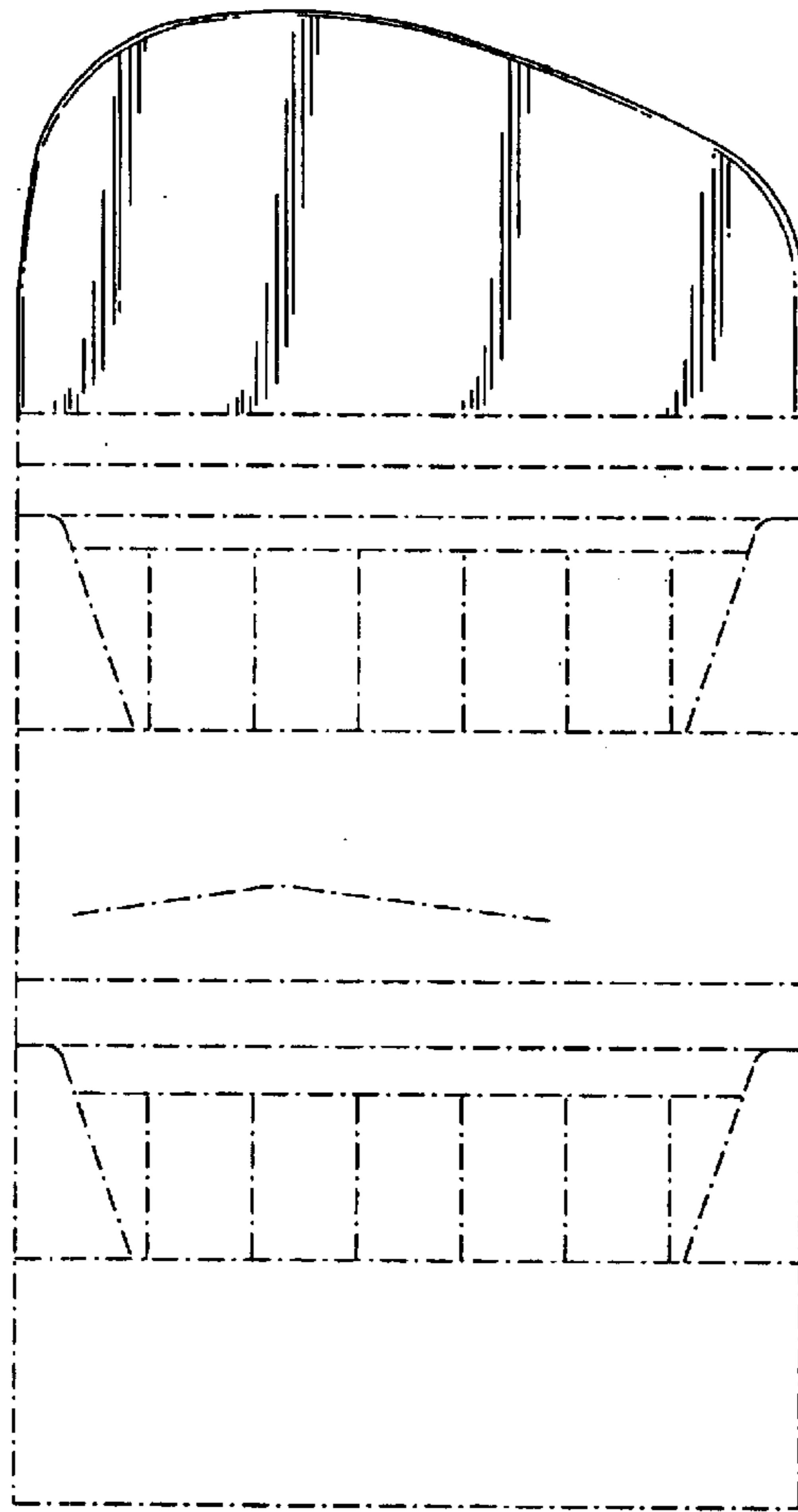

FIG. 8

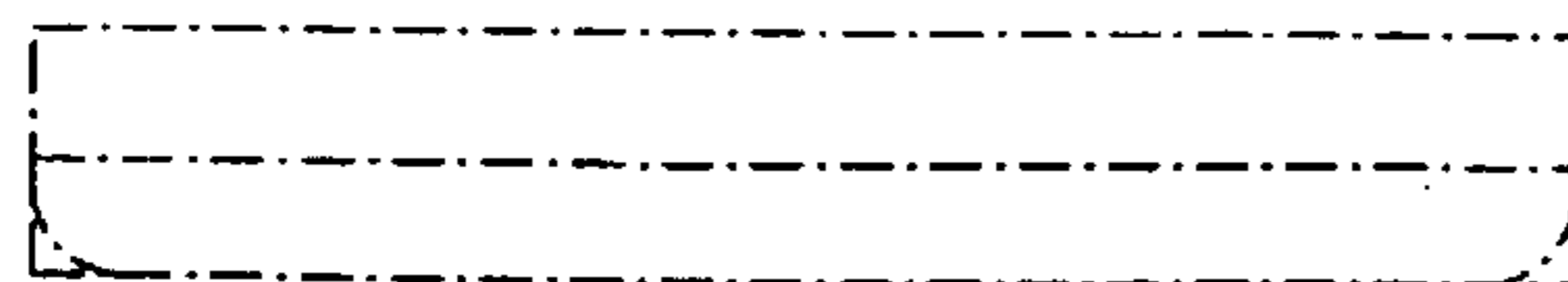

FIG. 10

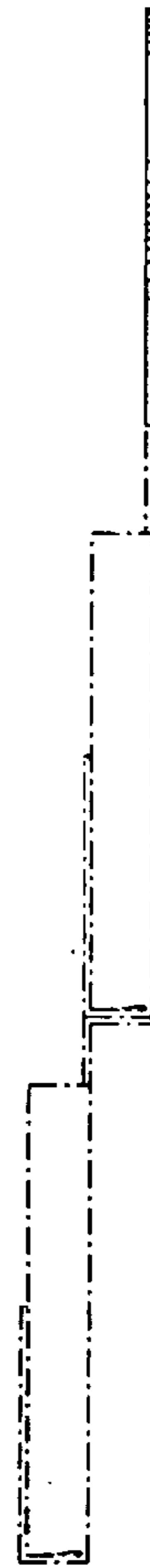

FIG. 11

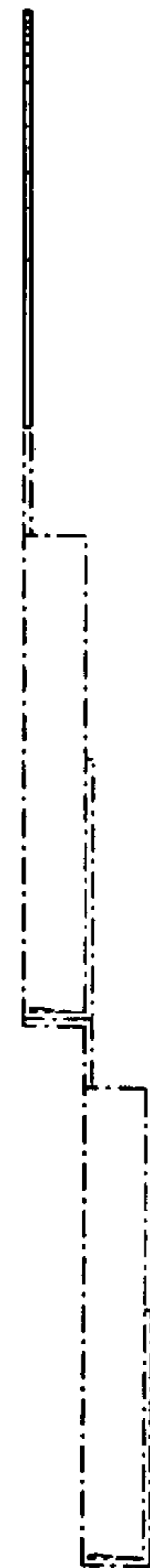

FIG. 12

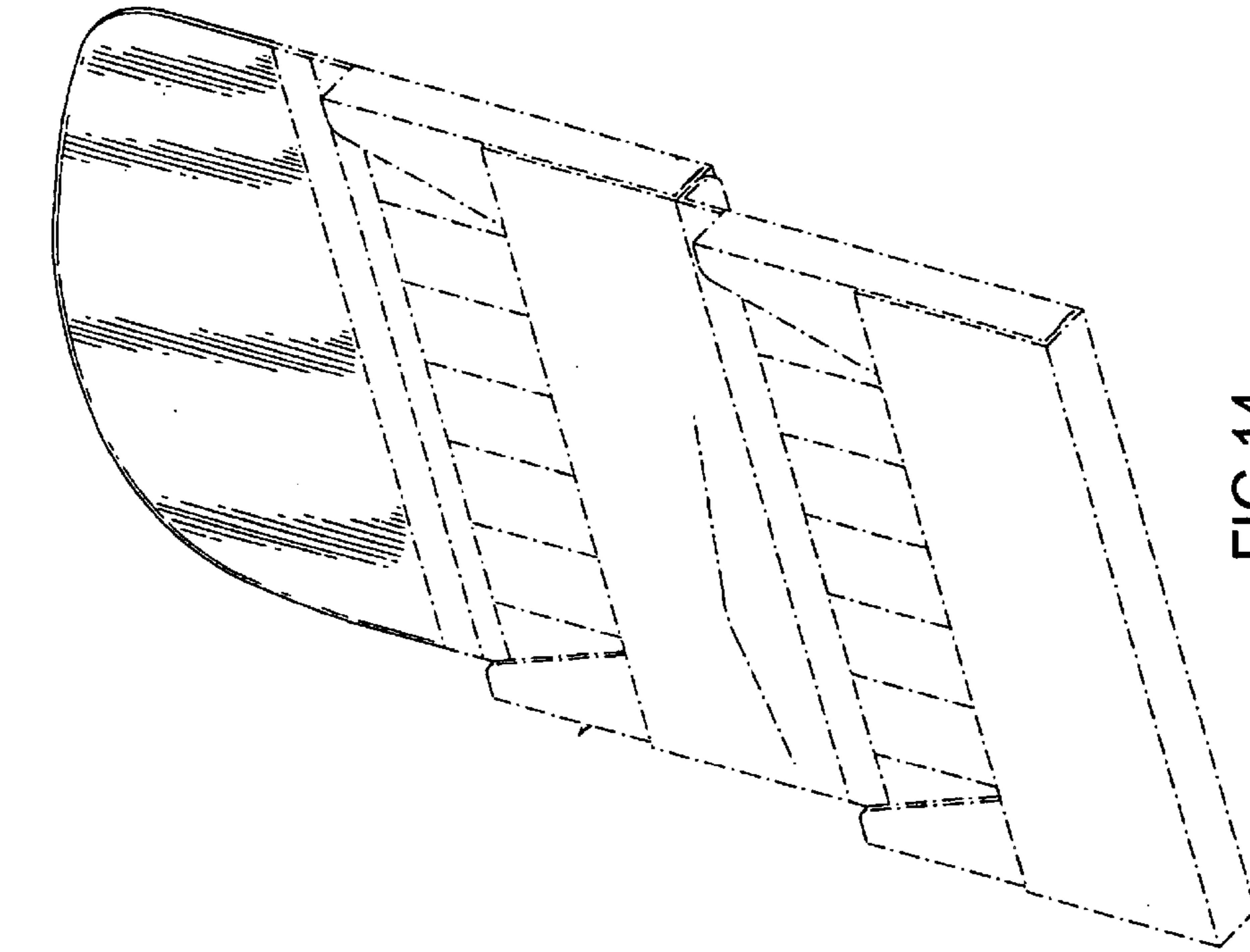

FIG.14

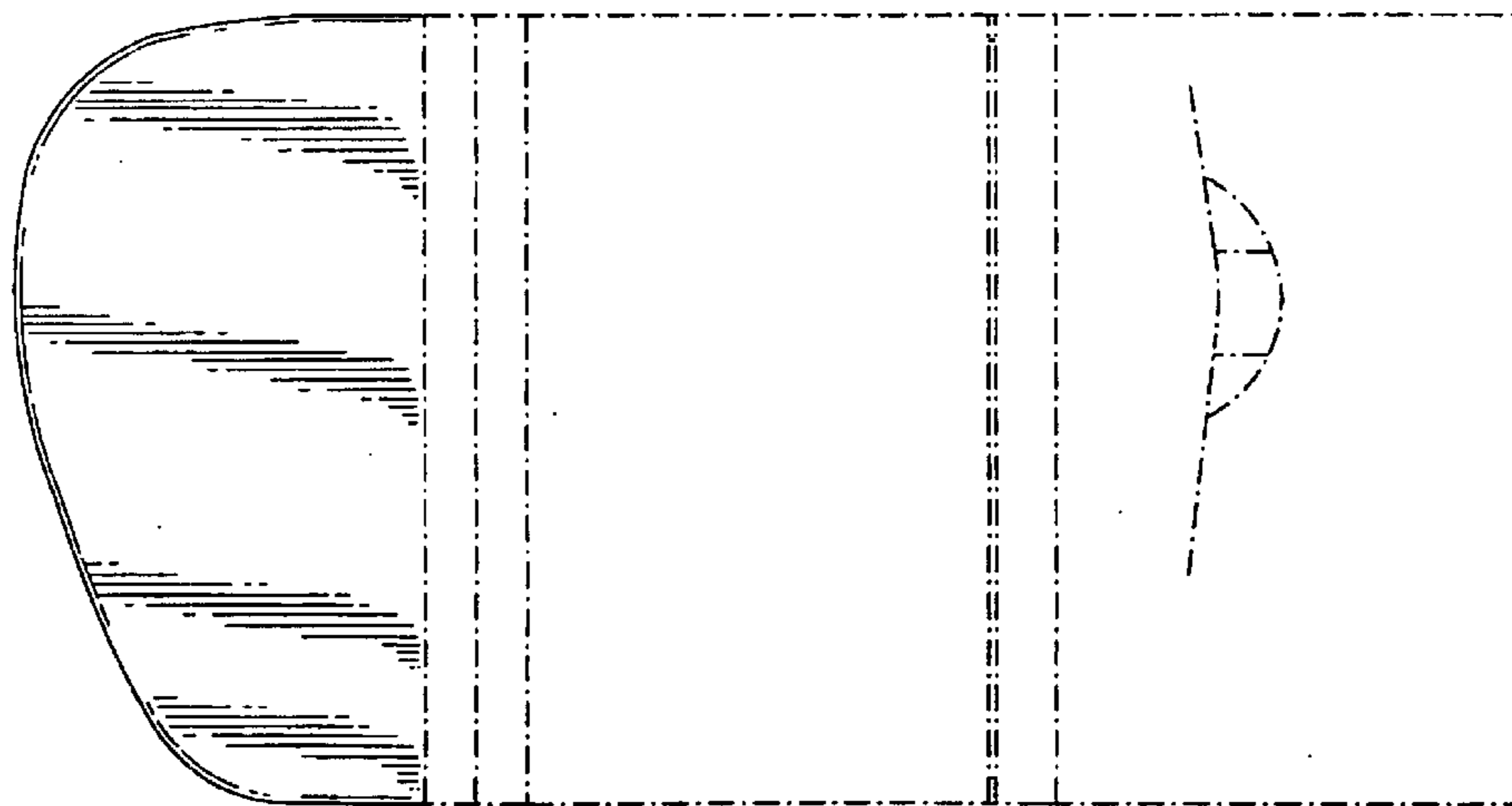

FIG.13