

US00D540612S

(12) **United States Design Patent**  
**Jensen et al.**

(10) **Patent No.:** **US D540,612 S**

(45) **Date of Patent:** **\*\* Apr. 17, 2007**

(54) **COOKTOP**

(75) Inventors: **Michael Hamish Jensen**, Dunedin (NZ); **Lindsay George Graham**, Otago (NZ)

(73) Assignee: **Fisher & Paykel Appliances Limited**, Auckland (NZ)

(\*\*) Term: **14 Years**

(21) Appl. No.: **29/260,649**

(22) Filed: **May 30, 2006**

(30) **Foreign Application Priority Data**

Dec. 19, 2005 (NZ) ..... 406949

(51) **LOC (8) Cl.** ..... **07-02**

(52) **U.S. Cl.** ..... **D7/346**

(58) **Field of Classification Search** ..... D7/339-341, D7/346-348, 402-407; 219/445, 445.1, 448.11, 219/453; 126/39 R, 214 R, 41 R, 211-212  
See application file for complete search history.

(56) **References Cited**

**U.S. PATENT DOCUMENTS**

- D312,748 S \* 12/1990 Jung et al. .... D7/407
- D326,387 S \* 5/1992 Monitto et al. .... D7/346
- 6,257,228 B1 \* 7/2001 Braccini ..... 126/211
- D450,526 S \* 11/2001 Busalt ..... D7/346
- 6,691,699 B1 \* 2/2004 Fafet et al. .... 126/39 R
- D516,856 S \* 3/2006 Langhammer et al. .... D7/347
- D524,104 S \* 7/2006 Johnson ..... D7/407

\* cited by examiner

*Primary Examiner*—Catherine R. Oliver

(74) *Attorney, Agent, or Firm*—Trexler, Bushnell, Giangiorgi, Blackstone & Marr, Ltd.

(57) **CLAIM**

The ornamental design for a cooktop, as shown and described.

**DESCRIPTION**

FIG. 1 is a perspective view of the cooktop shown with the cooking array extended.

FIG. 2 is a top view of the cooktop shown with the cooking array extended.

FIG. 3 is a bottom view of the cooktop.

FIG. 4 is a rear view of the cooktop with the cooking array extended.

FIG. 5 is a front view of the cooktop with the cooking array extended.

FIG. 6 is a right side view of the cooktop with the cooking array extended.

FIG. 7 is a left side view of the cooktop with the cooking array extended.

FIG. 8 is a perspective view of the cooktop shown with the cooking array retracted.

FIG. 9 is a top view of the cooktop shown with the cooking array retracted.

FIG. 10 is a bottom view of the cooktop.

FIG. 11 is a rear view of the cooktop with the cooking array retracted.

FIG. 12 is a front view of the cooktop with the cooking array retracted.

FIG. 13 is a right side view of the cooktop with the cooking array retracted; and,

FIG. 14 is a left side view of the cooktop with the cooking array retracted.

**1 Claim, 8 Drawing Sheets**

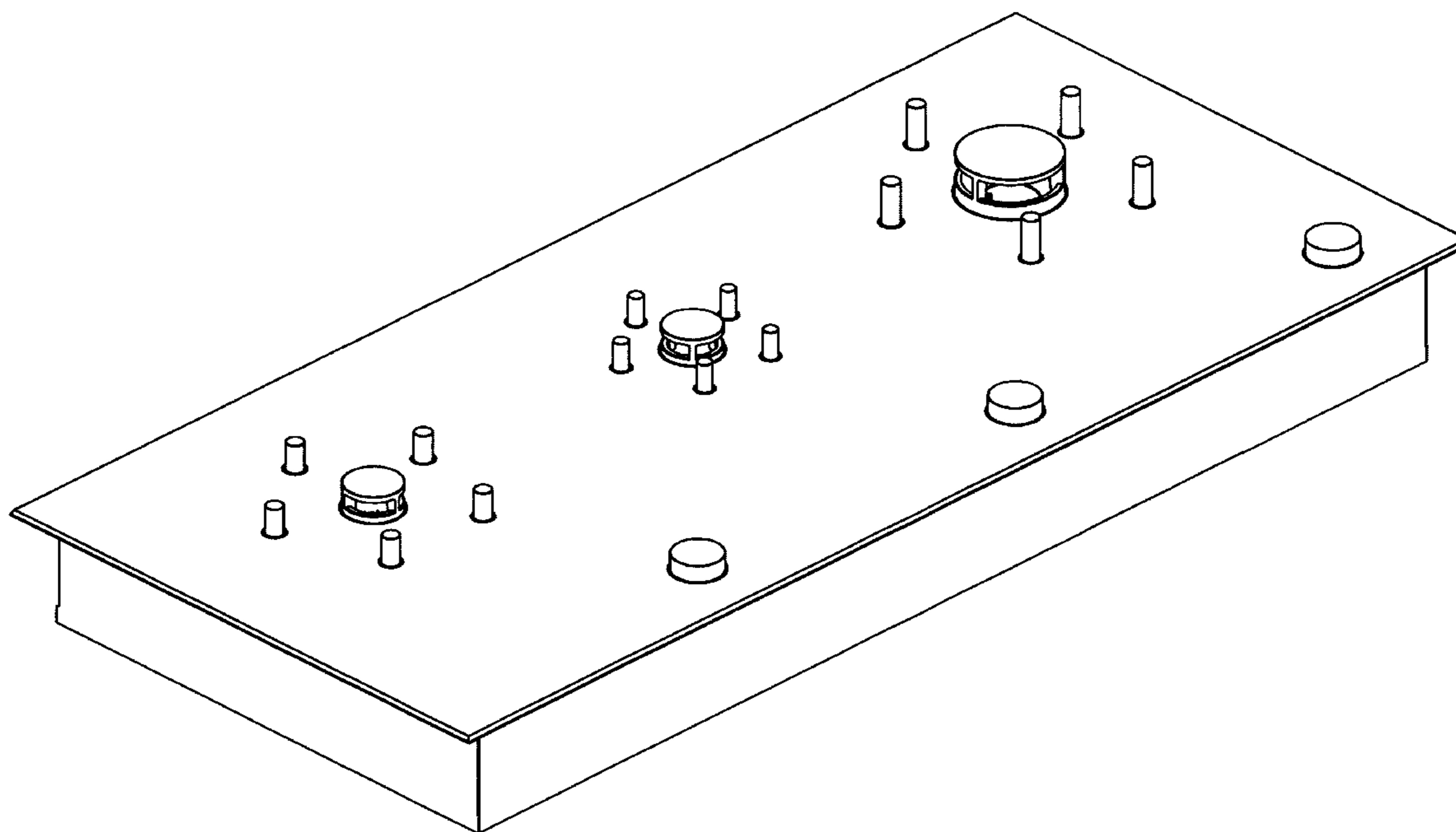

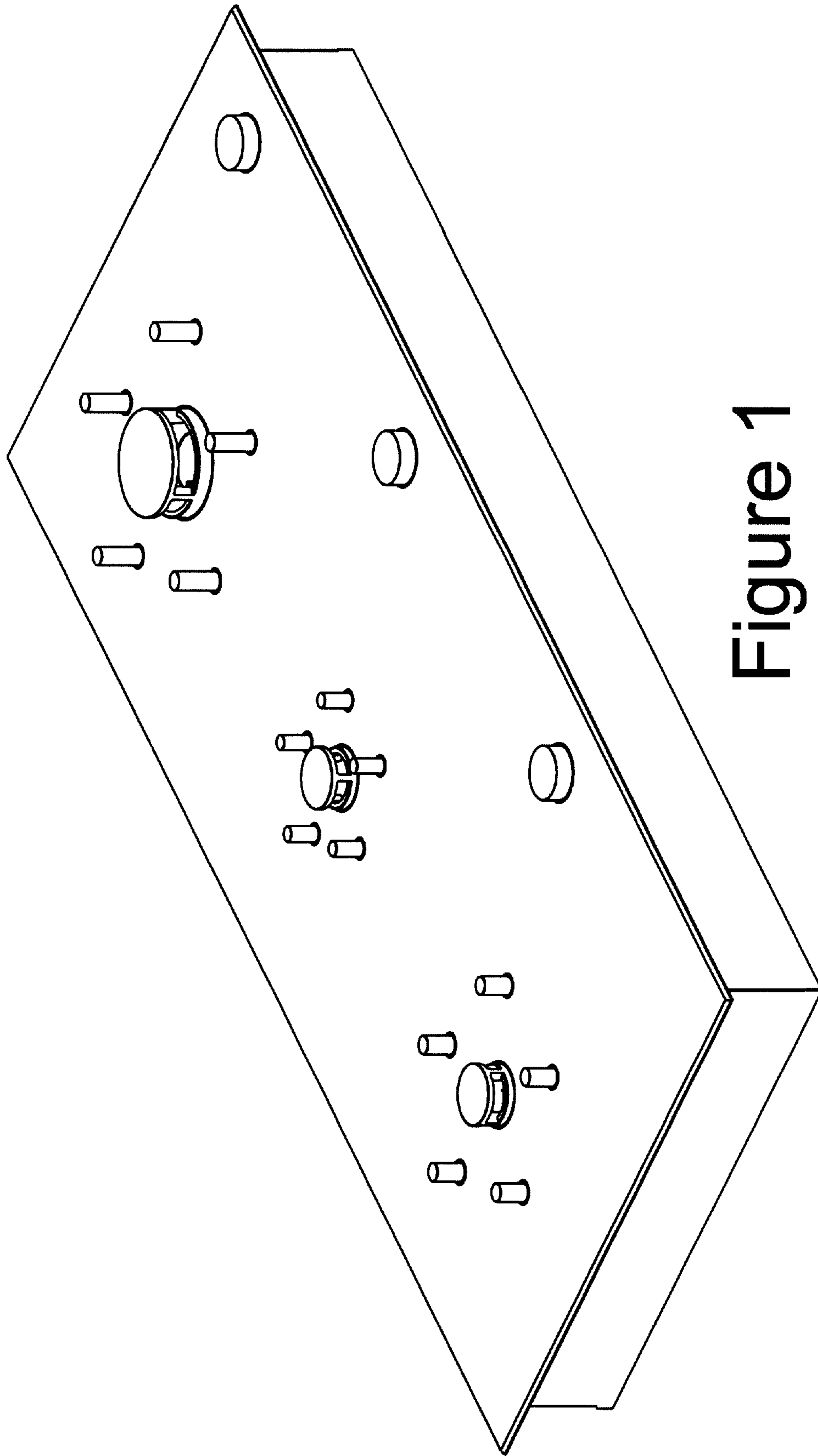

Figure 1

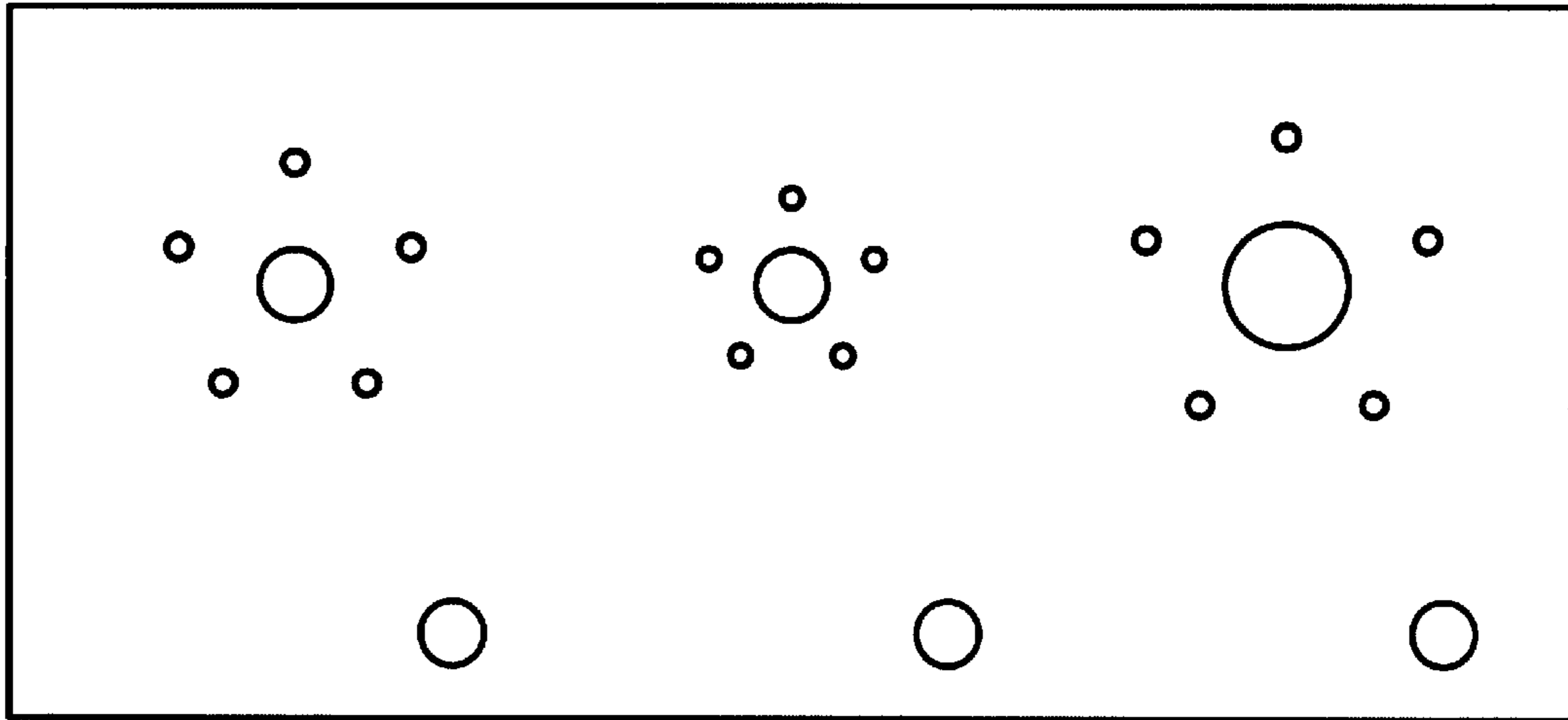

Figure 2

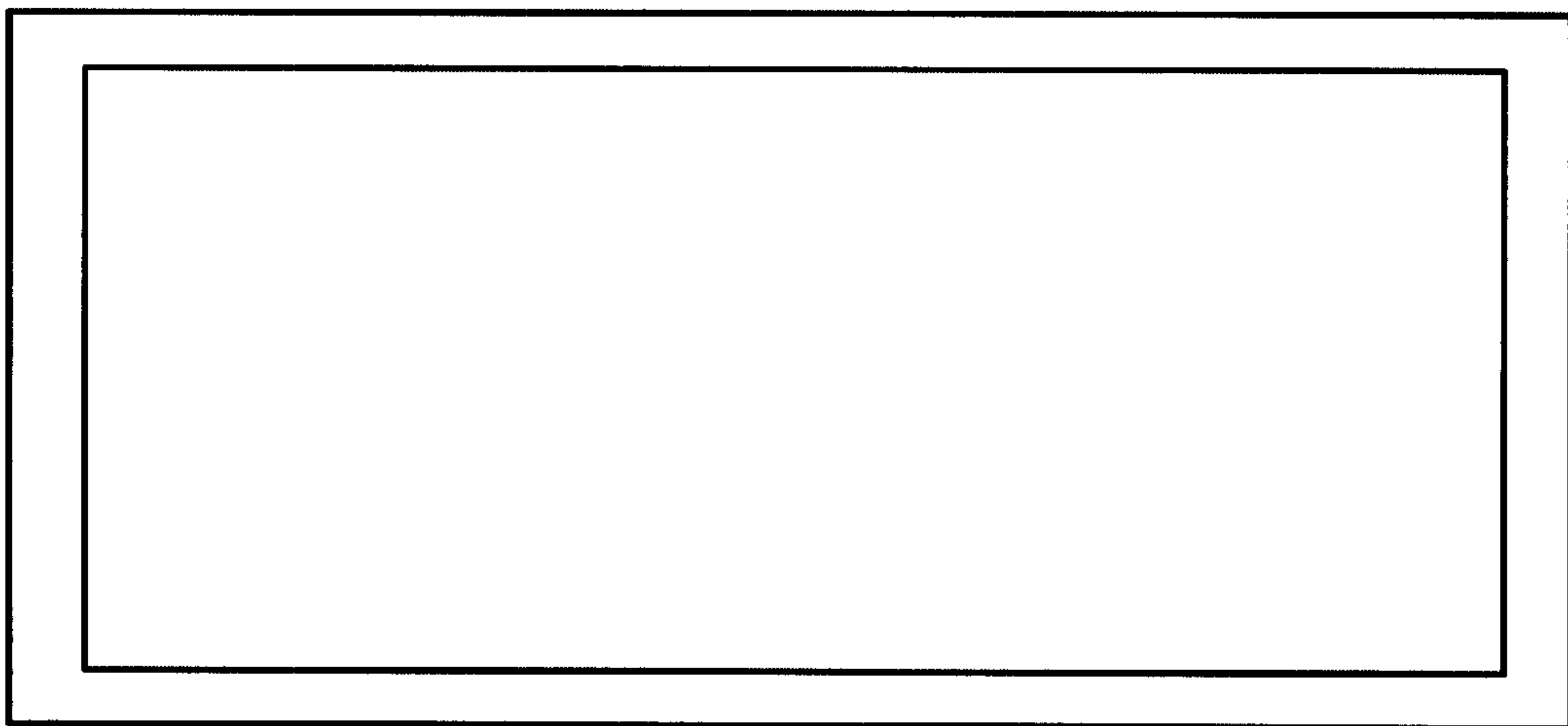

Figure 3

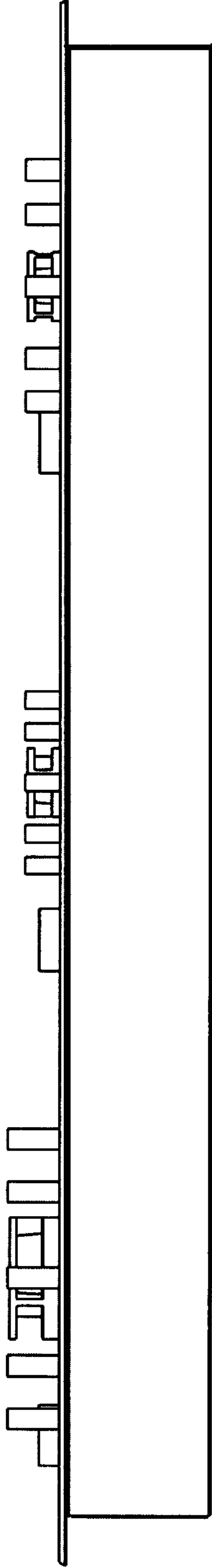

Figure 4

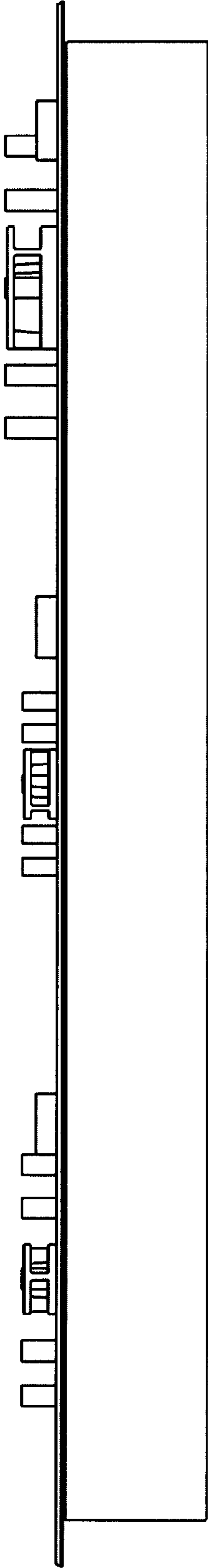

Figure 5

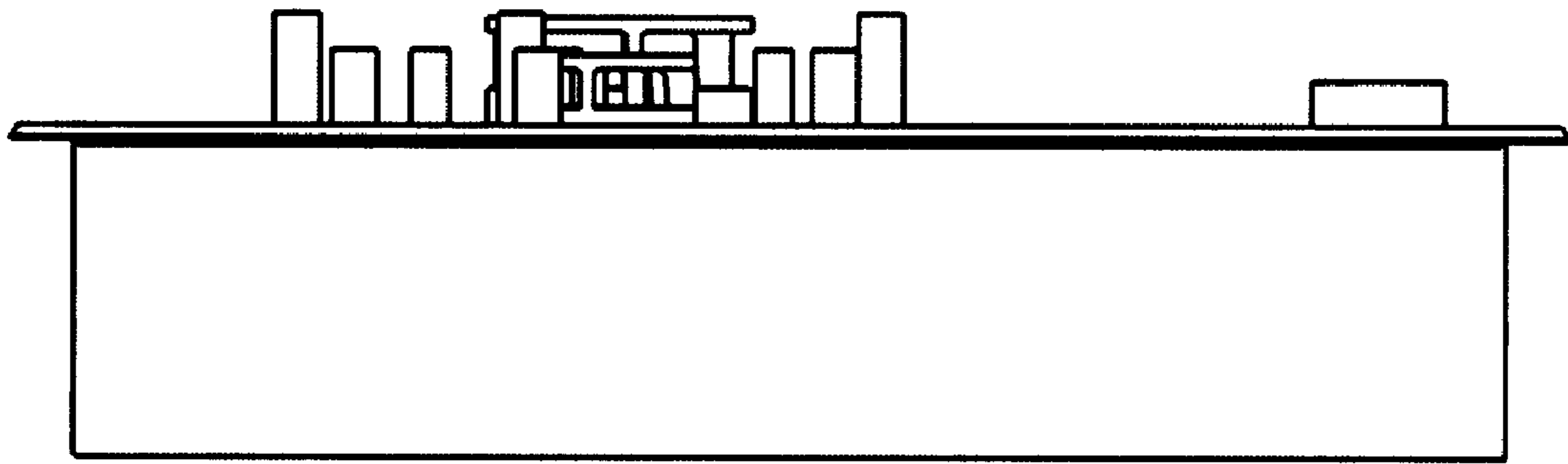

Figure 6

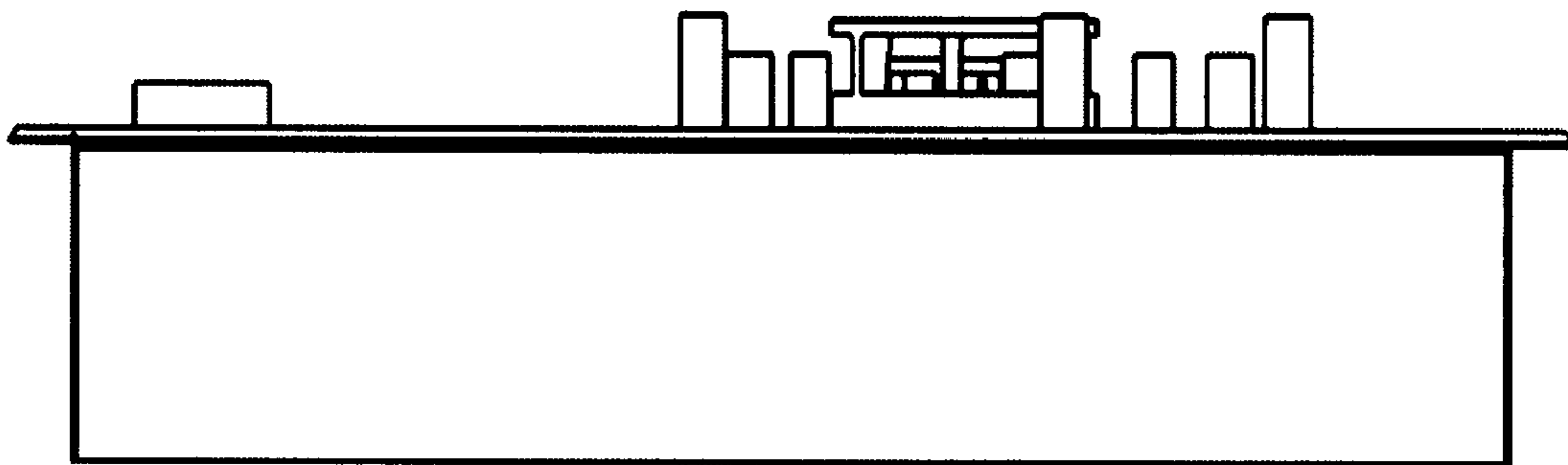

Figure 7

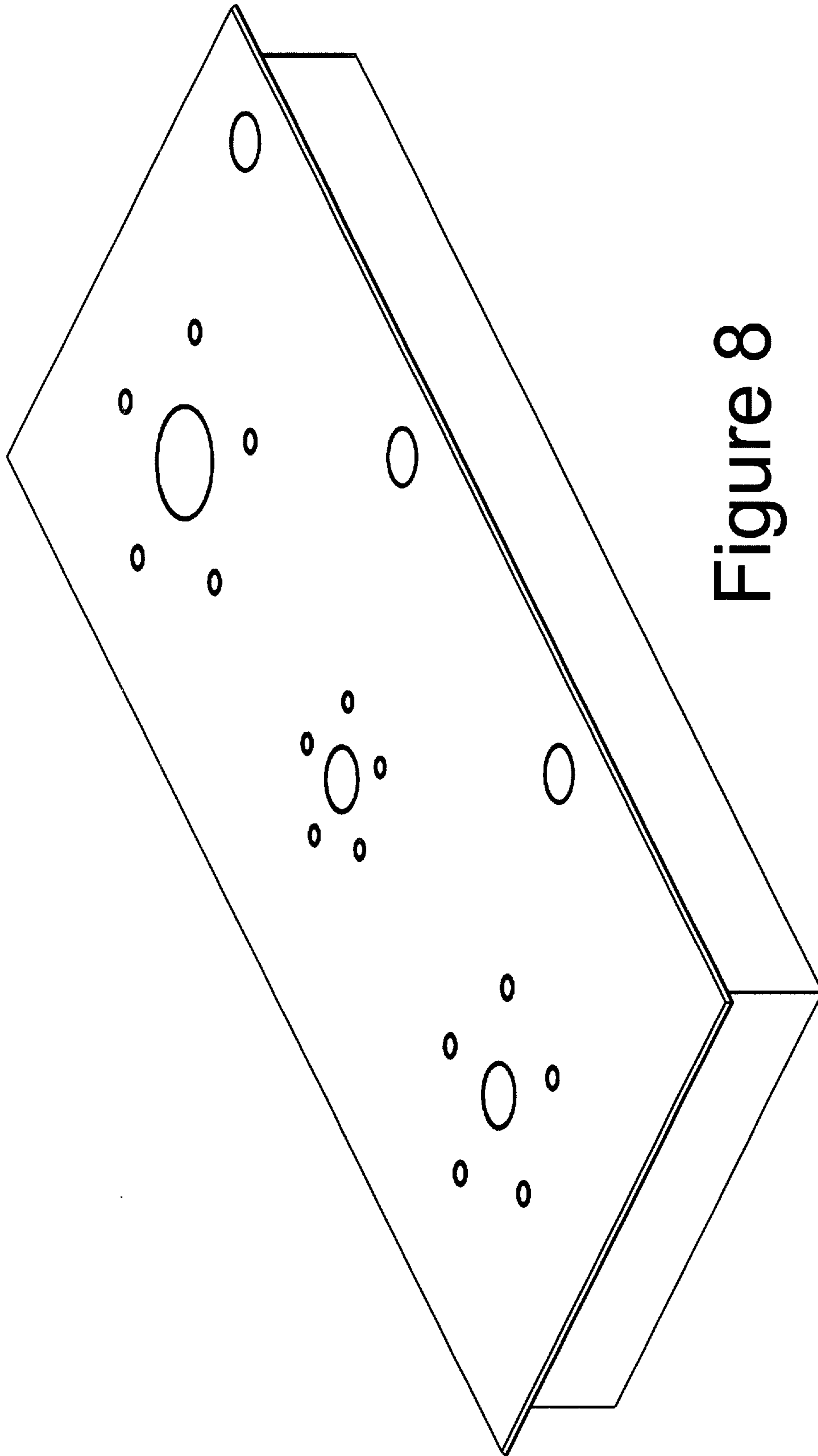

Figure 8

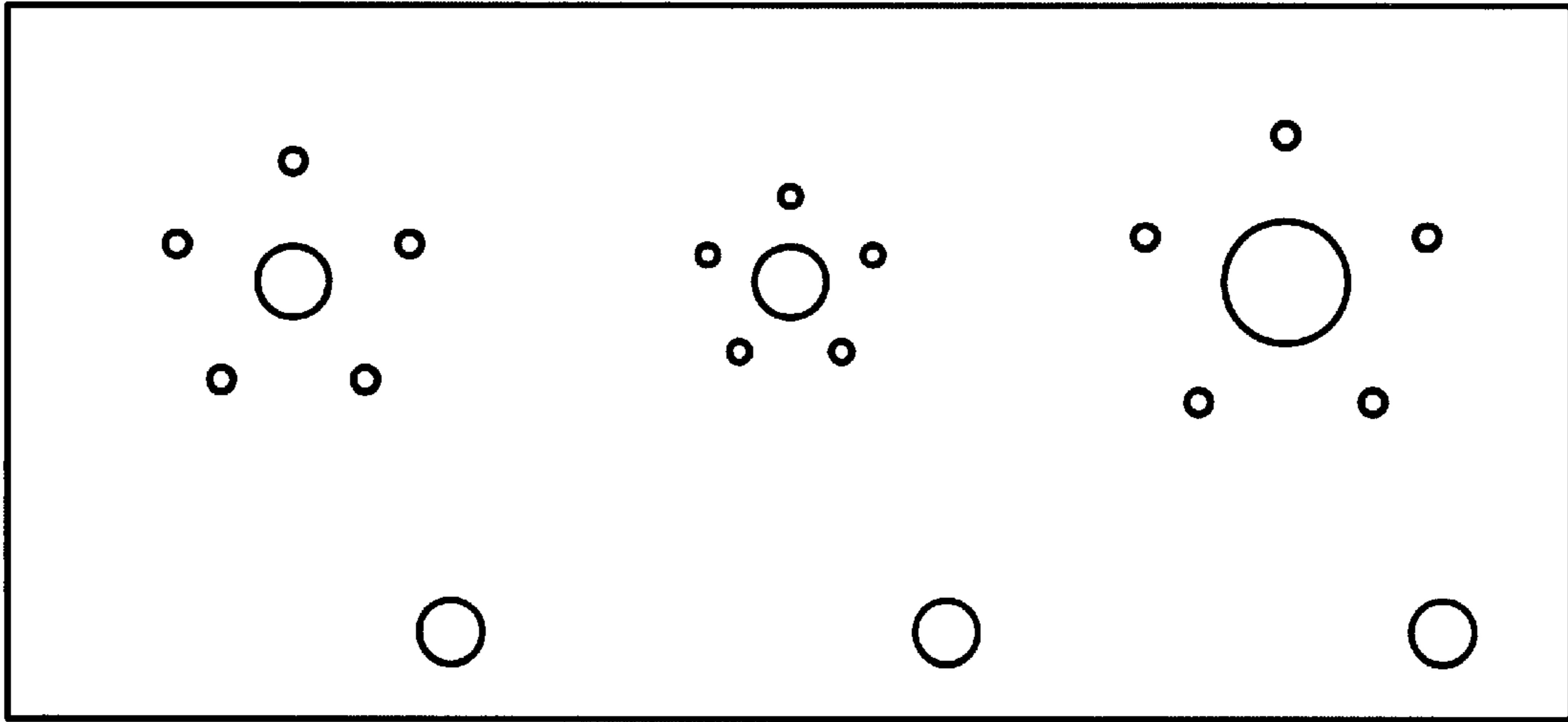

Figure 9

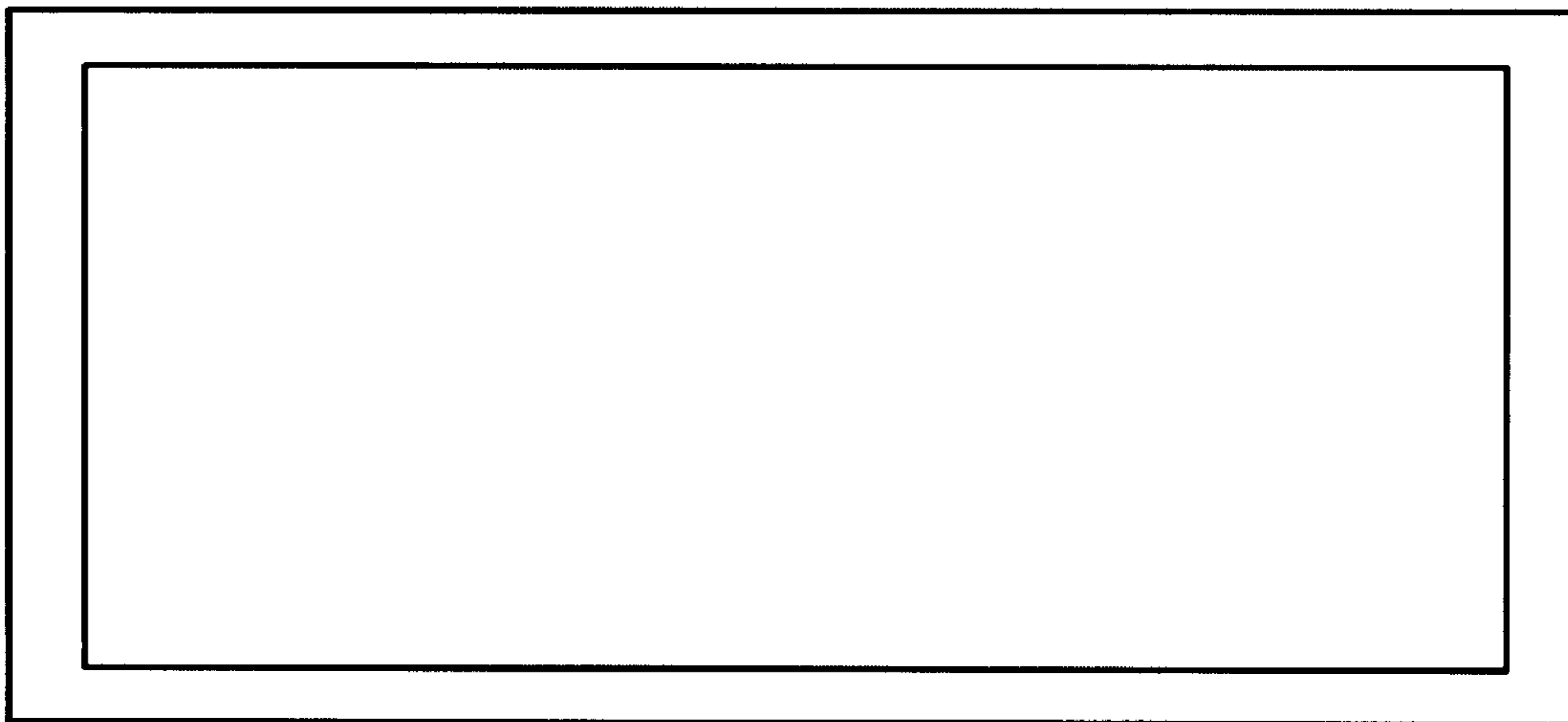

Figure 10

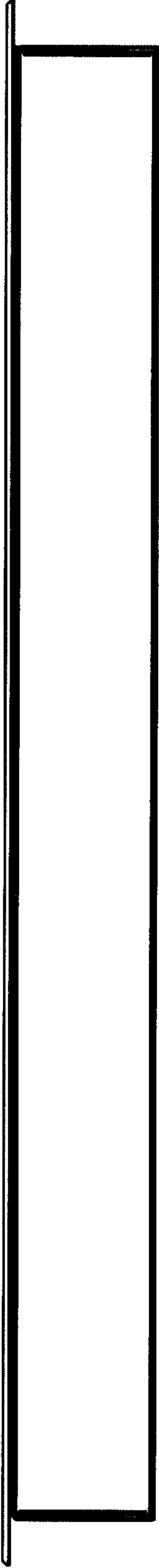

Figure 11

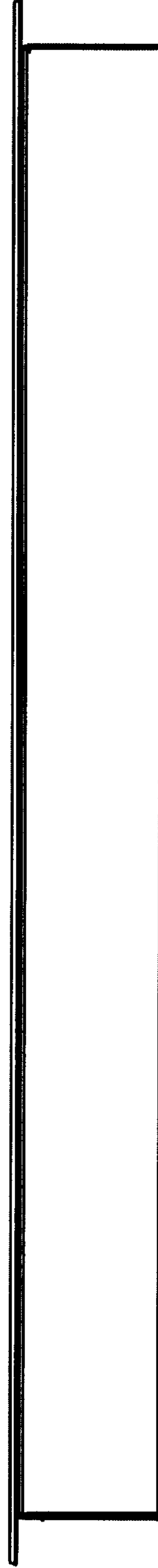

Figure 12



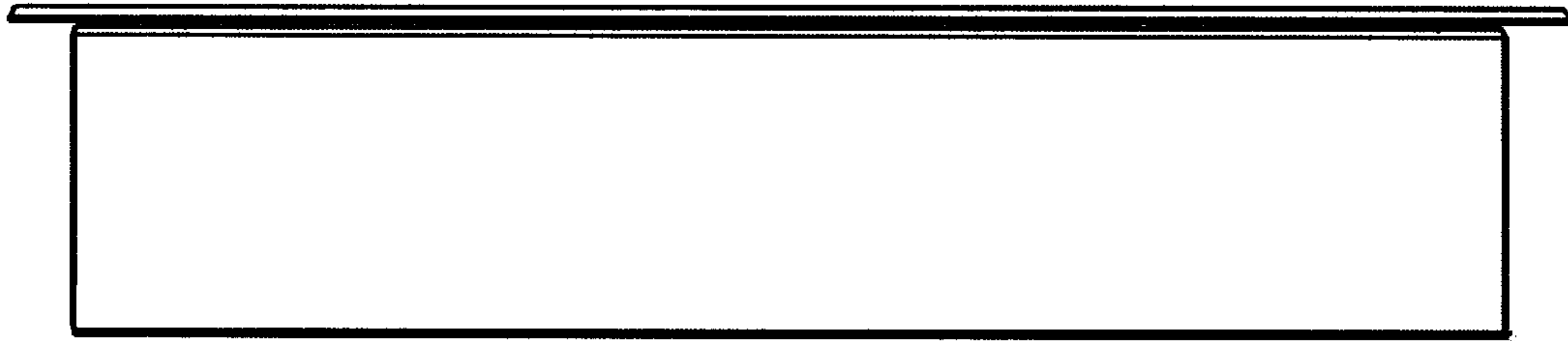

Figure 13

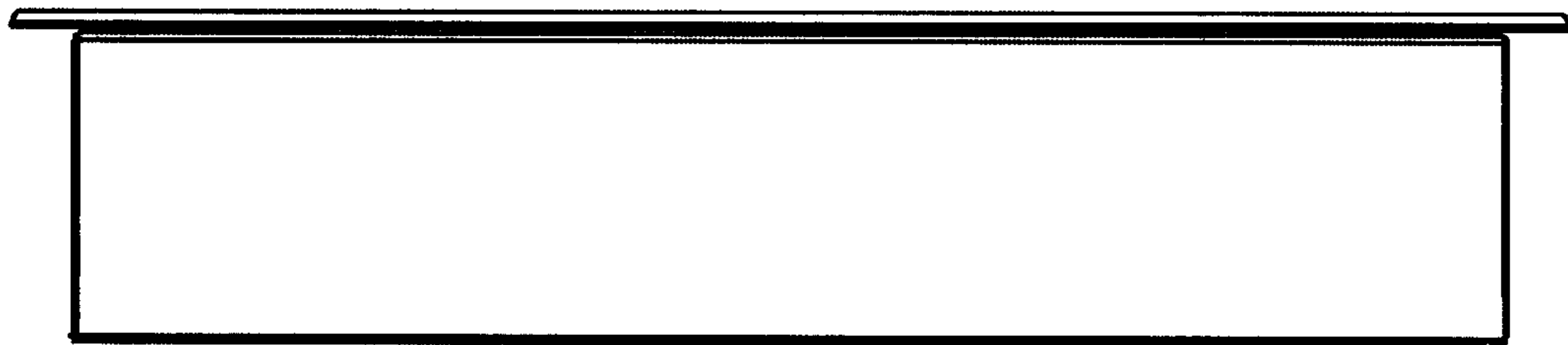

Figure 14