



US00D540608S

(12) **United States Design Patent**
Cahen

(10) **Patent No.:** **US D540,608 S**

(45) **Date of Patent:** **** Apr. 17, 2007**

(54) **COFFEE MACHINE**

(75) Inventor: **Antoine Cahen**, Lausanne (CH)

(73) Assignee: **Societe des Produits Nestle S.A.**,
Vevey (CH)

(**) Term: **14 Years**

(21) Appl. No.: **29/254,253**

(22) Filed: **Feb. 20, 2006**

(30) **Foreign Application Priority Data**

Aug. 24, 2005 (CH) 132081

(51) **LOC (8) Cl.** **07-01**

(52) **U.S. Cl.** **D7/309; D7/311; D7/306**

(58) **Field of Classification Search** D7/300,
D7/305-311; 222/185.1, 129.1; 99/290-292,
99/307, 305, 279

See application file for complete search history.

(56) **References Cited**

U.S. PATENT DOCUMENTS

D204,729 S	*	5/1966	Hedeman	D7/311
D423,861 S	*	5/2000	Graffius	D7/305
D449,199 S	*	10/2001	Cahen	D7/309
D449,488 S	*	10/2001	Cahen	D7/309
D495,187 S	*	8/2004	Cahen	D7/309
D495,188 S	*	8/2004	Cahen	D7/309

D495,915 S	*	9/2004	Cahen	D7/309
D499,599 S	*	12/2004	Morrison	D7/309
D502,627 S	*	3/2005	Cahen	D7/306
D523,279 S	*	6/2006	Zemp	D7/309

* cited by examiner

Primary Examiner—M. N. Pandozzi

(74) *Attorney, Agent, or Firm*—Bell, Boyd & Lloyd LLC

(57) **CLAIM**

The ornamental design for a coffee machine, as shown and described.

DESCRIPTION

FIG. 1 illustrates a front perspective view of the coffee machine;

FIG. 2 illustrates a front view of the coffee machine of FIG. 1;

FIG. 3 illustrates a back view of the coffee machine of FIG. 1;

FIG. 4 illustrates a top view of the coffee machine of FIG. 1;

FIG. 5 illustrates a bottom view of the coffee machine of FIG. 1;

FIG. 6 illustrates a right side view of the coffee machine of FIG. 1; and,

FIG. 7 illustrates a left side view of the coffee machine of FIG. 1.

1 Claim, 5 Drawing Sheets

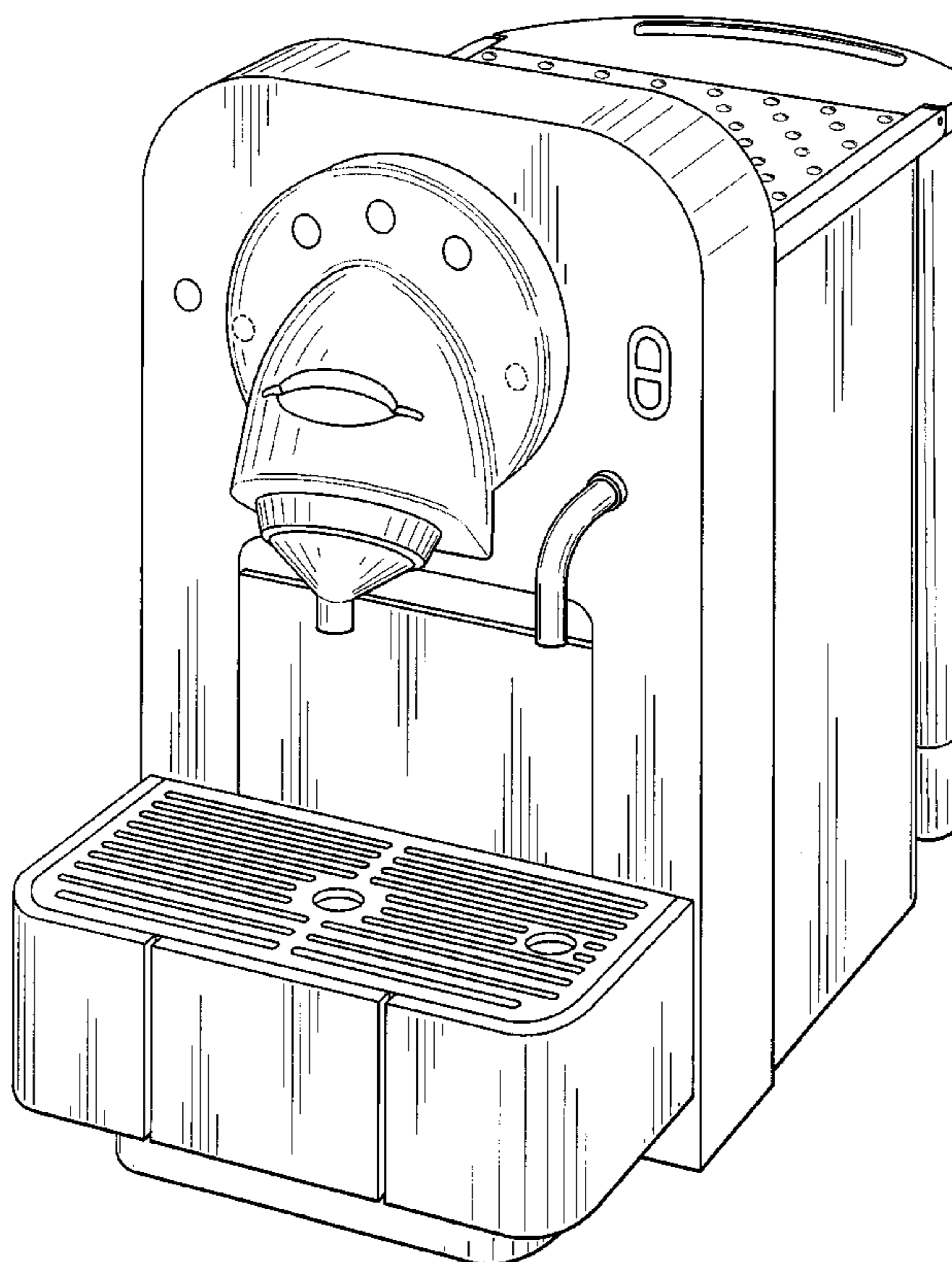

FIG. 1

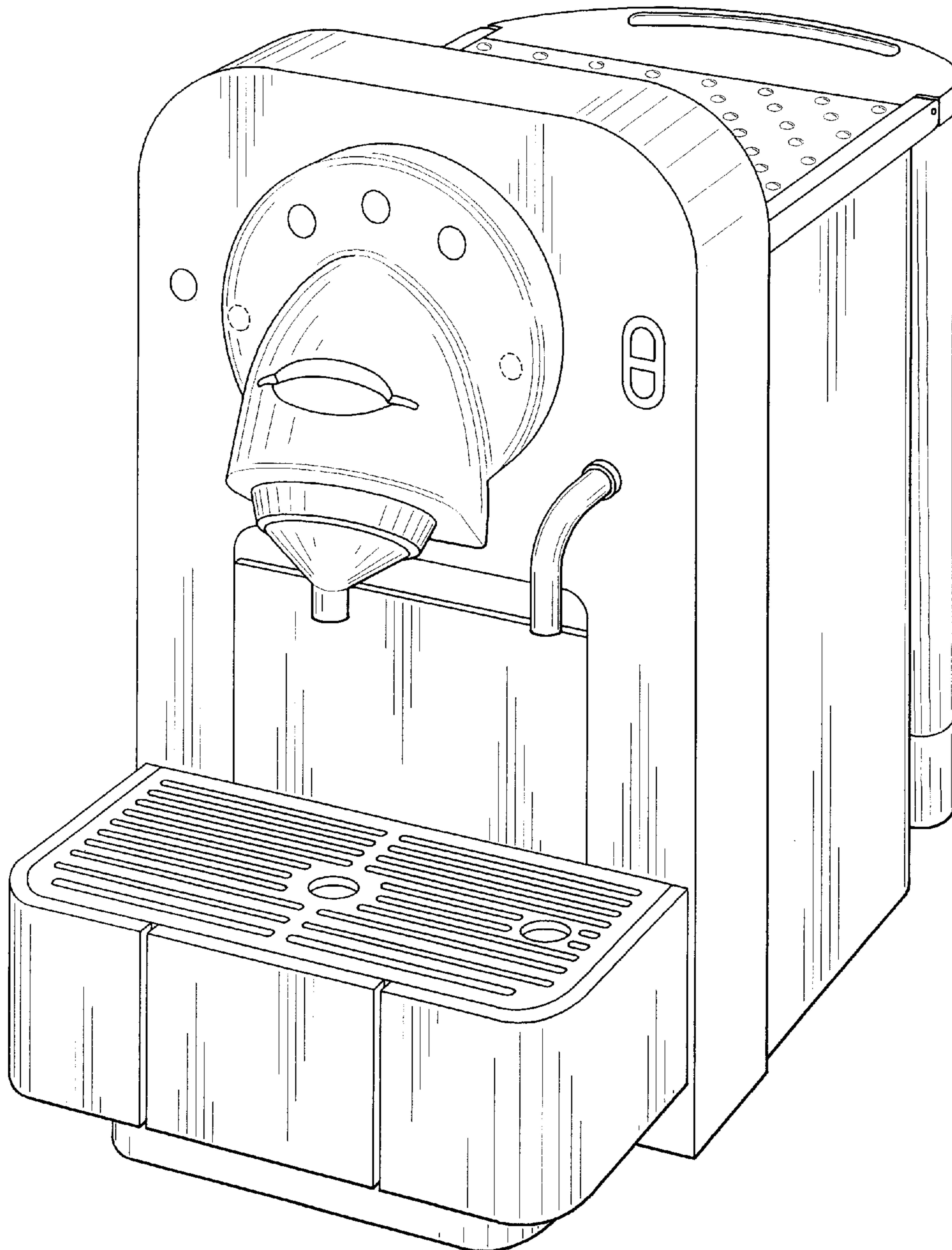

FIG.3

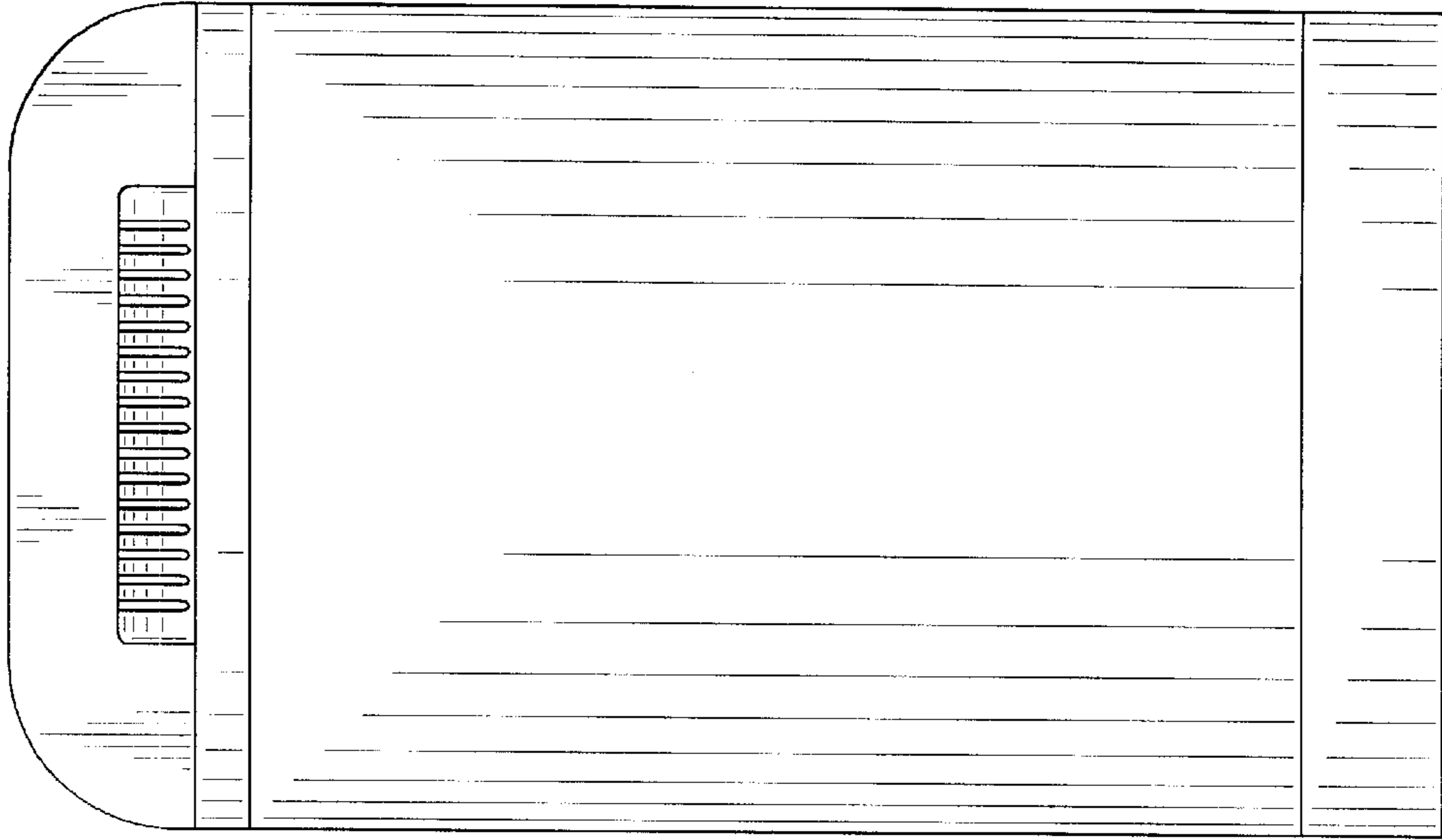
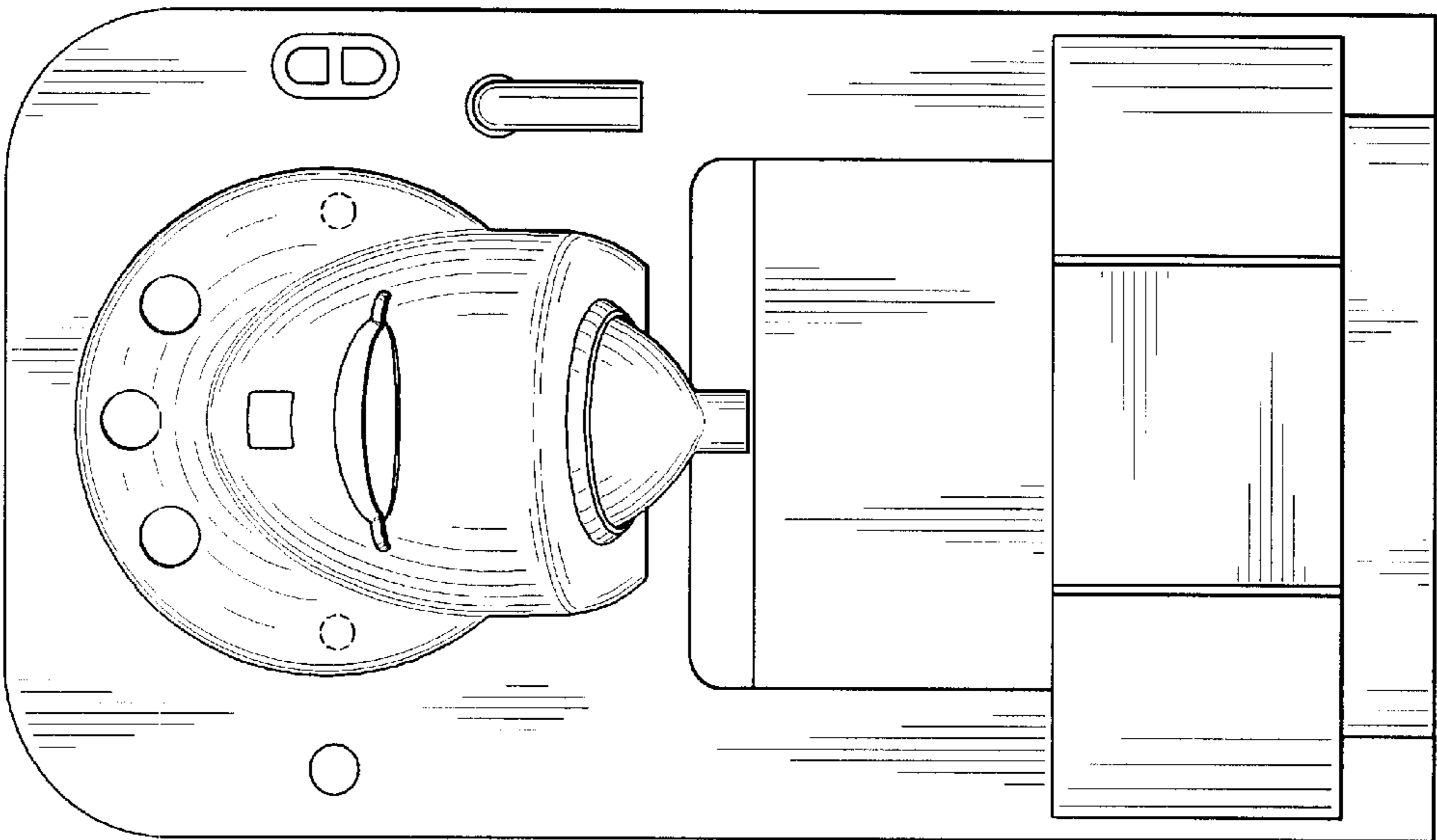

FIG.2



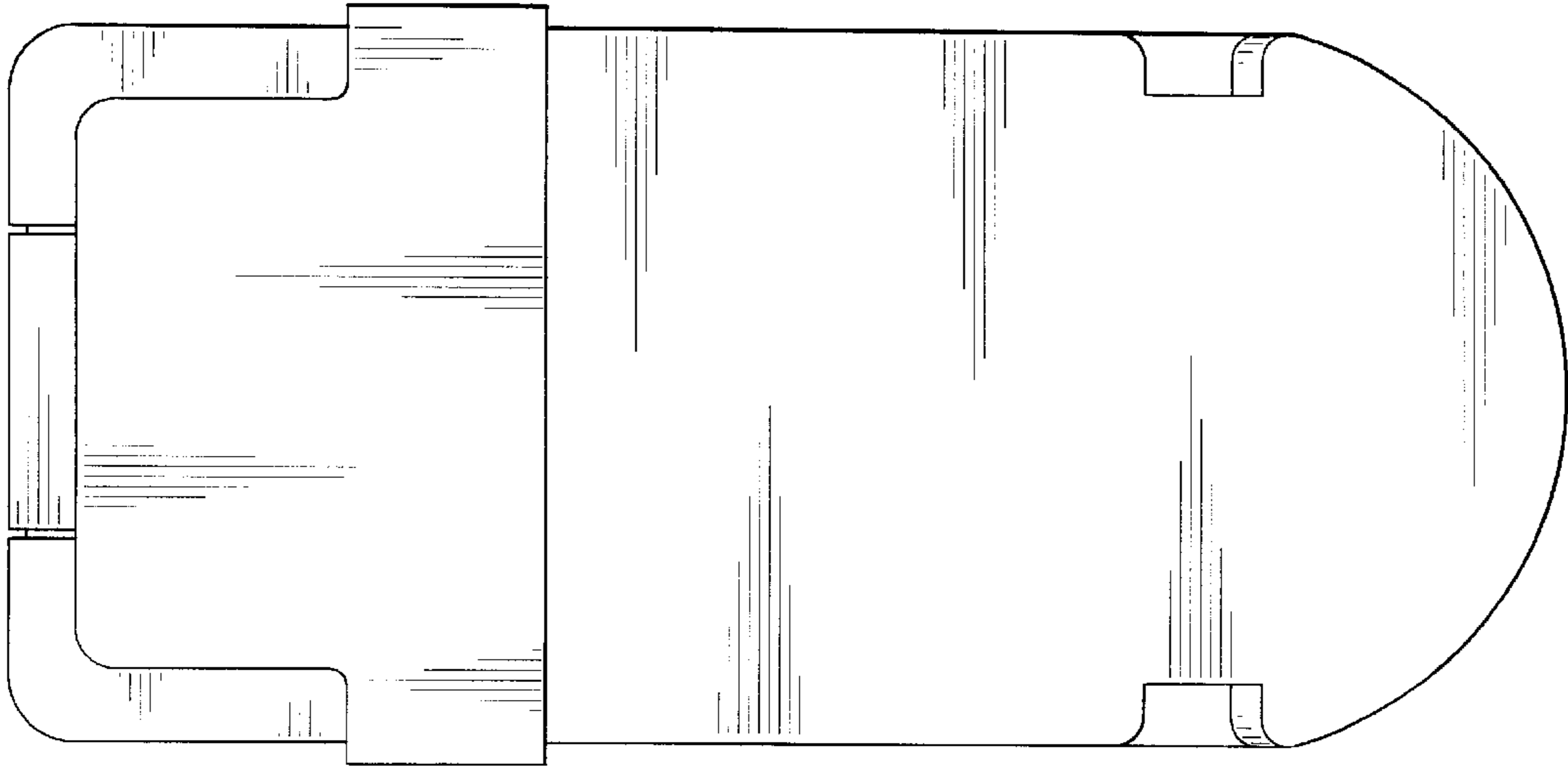

FIG. 5

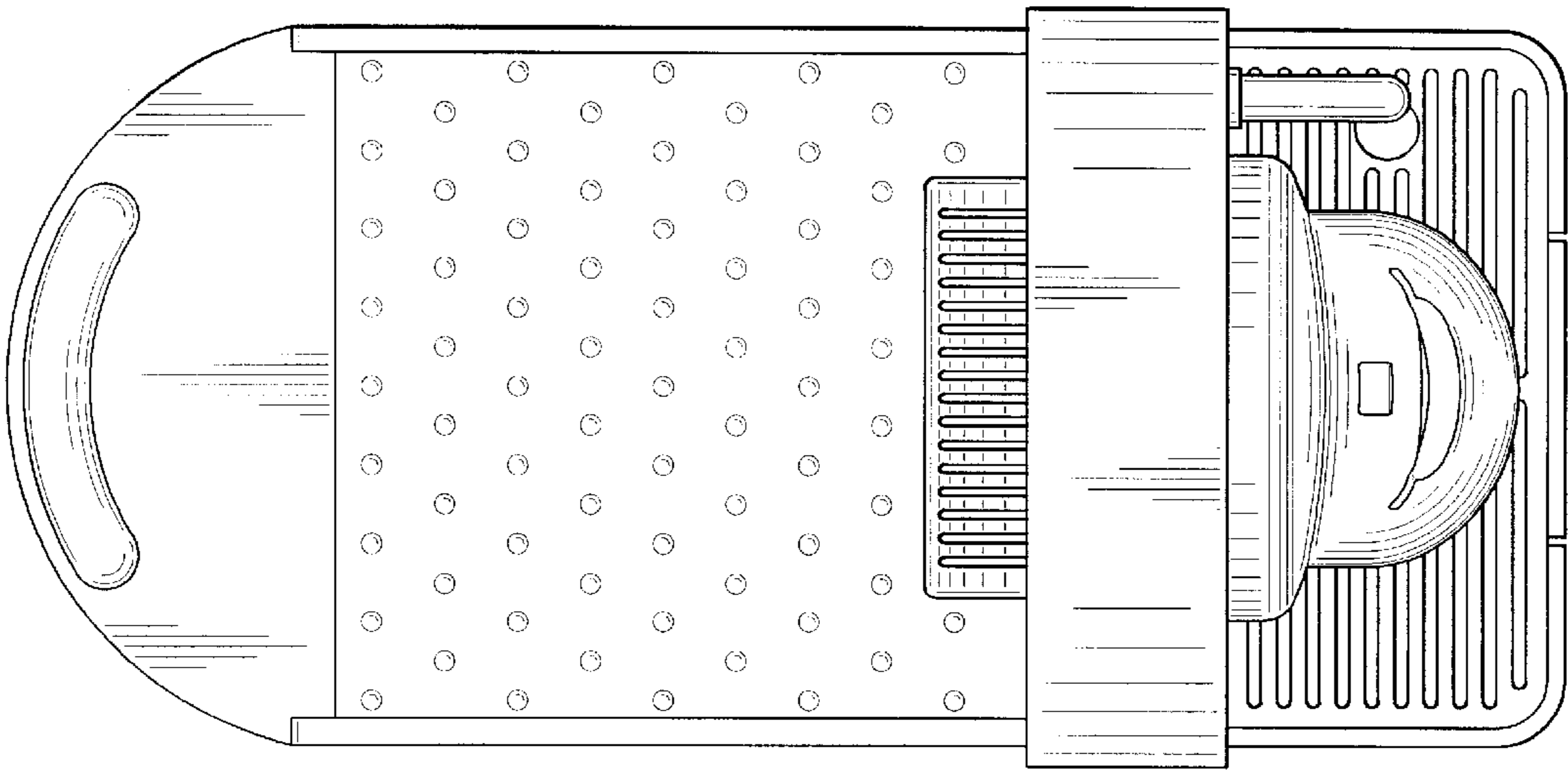

FIG. 4

FIG. 6

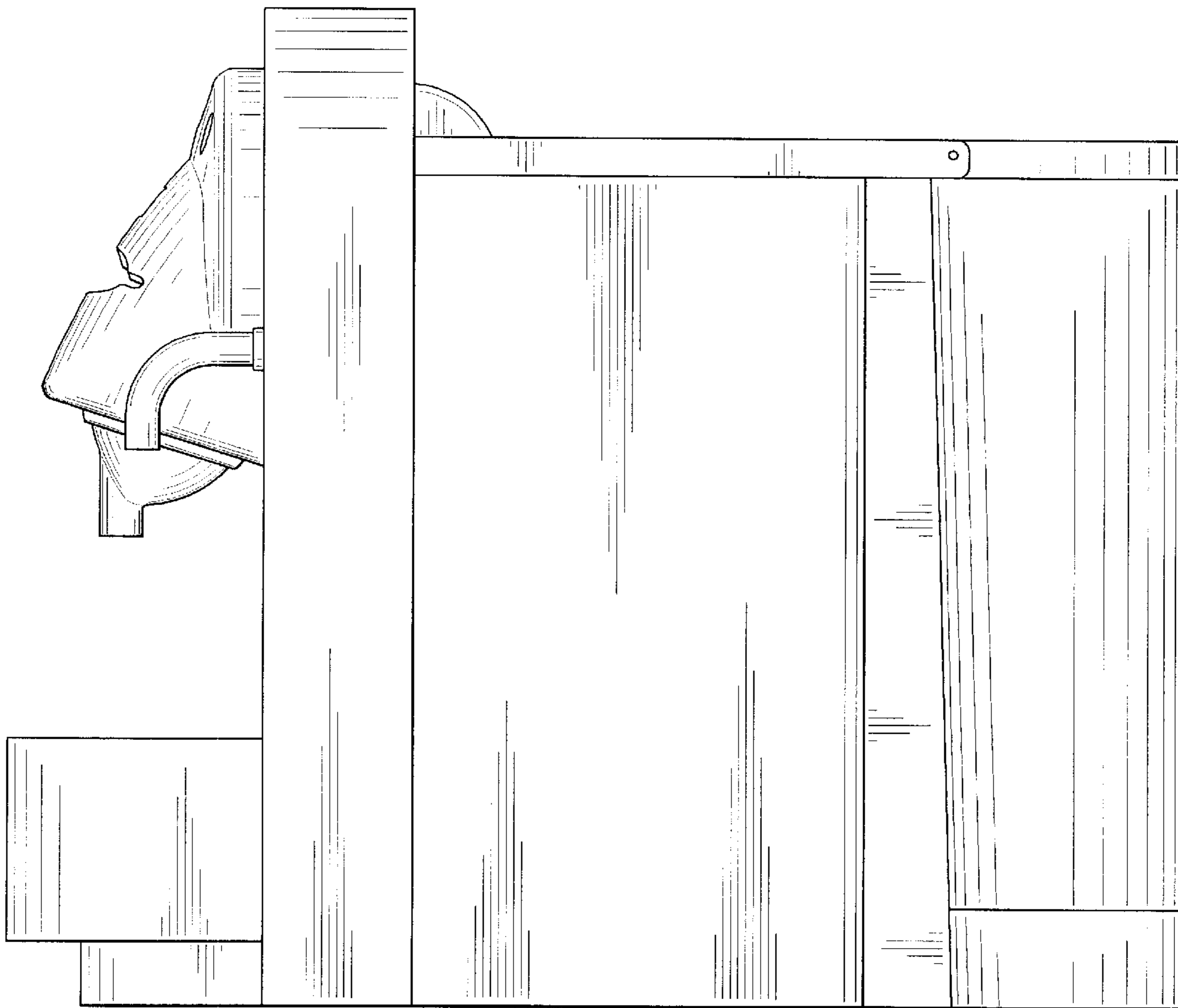

FIG. 7

