

US00D540543S

(12) **United States Design Patent**
Hay

(10) **Patent No.:** **US D540,543 S**

(45) **Date of Patent:** **** Apr. 17, 2007**

(54) **CLEANING IMPLEMENT**

(75) **Inventor:** **Christopher James Mccaughan Hay,**
Causeway Bay (HK)

(73) **Assignee:** **Hayco Manufacturing Limited,**
Causeway Bay (HK)

(**) **Term:** **14 Years**

(21) **Appl. No.:** **29/200,397**

(22) **Filed:** **Feb. 27, 2004**

(51) **LOC (8) Cl.** **04-01**

(52) **U.S. Cl.** **D4/118; D4/120**

(58) **Field of Classification Search** D4/118-120,
D4/132, 134, 138; D32/42, 49, 51; 15/111,
15/114, 236.01, 236.02, 236.07, 236.08, 236.09,
15/244.1, 143.1

See application file for complete search history.

(56) **References Cited**

U.S. PATENT DOCUMENTS

4,961,662	A	*	10/1990	Chow et al.	401/42
D330,788	S	*	11/1992	Berti	D32/45
D366,962	S	*	2/1996	Whitaker	D4/116
D417,550	S	*	12/1999	Lu	D4/120
D445,257	S	*	7/2001	Hay	D4/120
6,425,701	B1	*	7/2002	Jacobs	401/6
D466,307	S	*	12/2002	Cantrell	D4/118
D468,107	S	*	1/2003	Shen	D4/118
D484,705	S	*	1/2004	Dotterman et al.	D4/138

* cited by examiner

Primary Examiner—Alan P. Douglas

Assistant Examiner—Lavone D. Tabor

(74) *Attorney, Agent, or Firm*—Buchanan Ingersoll &
Rooney PC

(57) **CLAIM**

The ornamental design for a “cleaning implement,” as shown and described.

DESCRIPTION

FIG. 1 is a perspective view showing one embodiment of a “cleaning implement” incorporating the design;

FIG. 2 is a top view thereof;

FIG. 3 is a bottom view thereof;

FIG. 4 is a side view thereof;

FIG. 5 is another side view thereof;

FIG. 6 is a front view thereof;

FIG. 7 is a rear view thereof;

FIG. 8 is a perspective view showing another embodiment of a “cleaning implement” incorporating the design;

FIG. 9 is a top view of the cleaning implement shown in FIG. 8;

FIG. 10 is a bottom view of the cleaning implement shown in FIG. 8;

FIG. 11 is a side view of the cleaning implement shown in FIG. 8;

FIG. 12 is another side view of the cleaning implement shown in FIG. 8;

FIG. 13 is a front view of the cleaning implement shown in FIG. 8;

FIG. 14 is a rear view of the cleaning implement shown in FIG. 8;

FIG. 15 is an exploded view of the sides shown in FIG. 8 with a portion of the implement being detached for clarity of illustration; and,

FIG. 16 is an exploded view of the side shown in FIG. 11.

FIG. 11 but with a portion thereof detached for illustrative purpose.

1 Claim, 16 Drawing Sheets

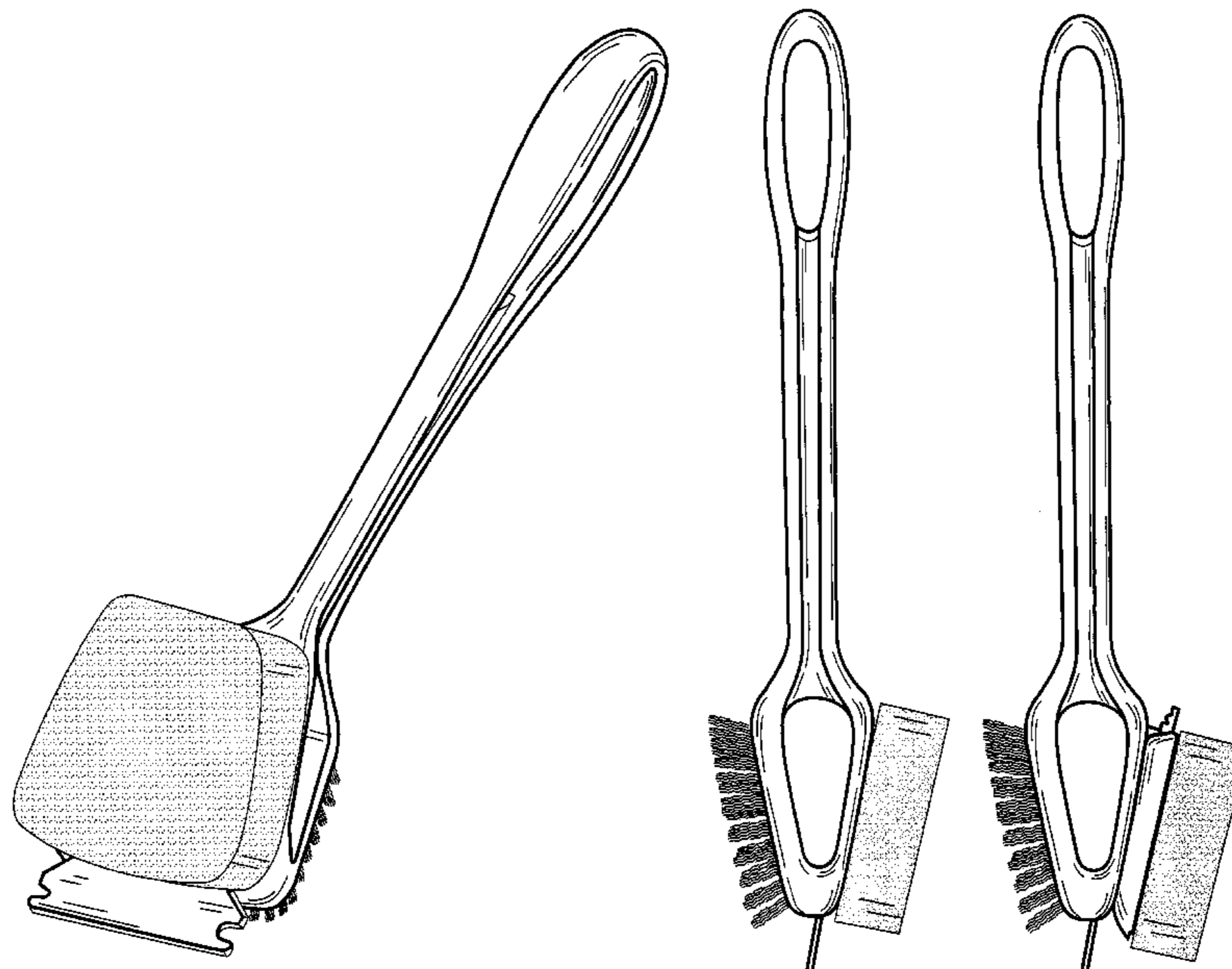

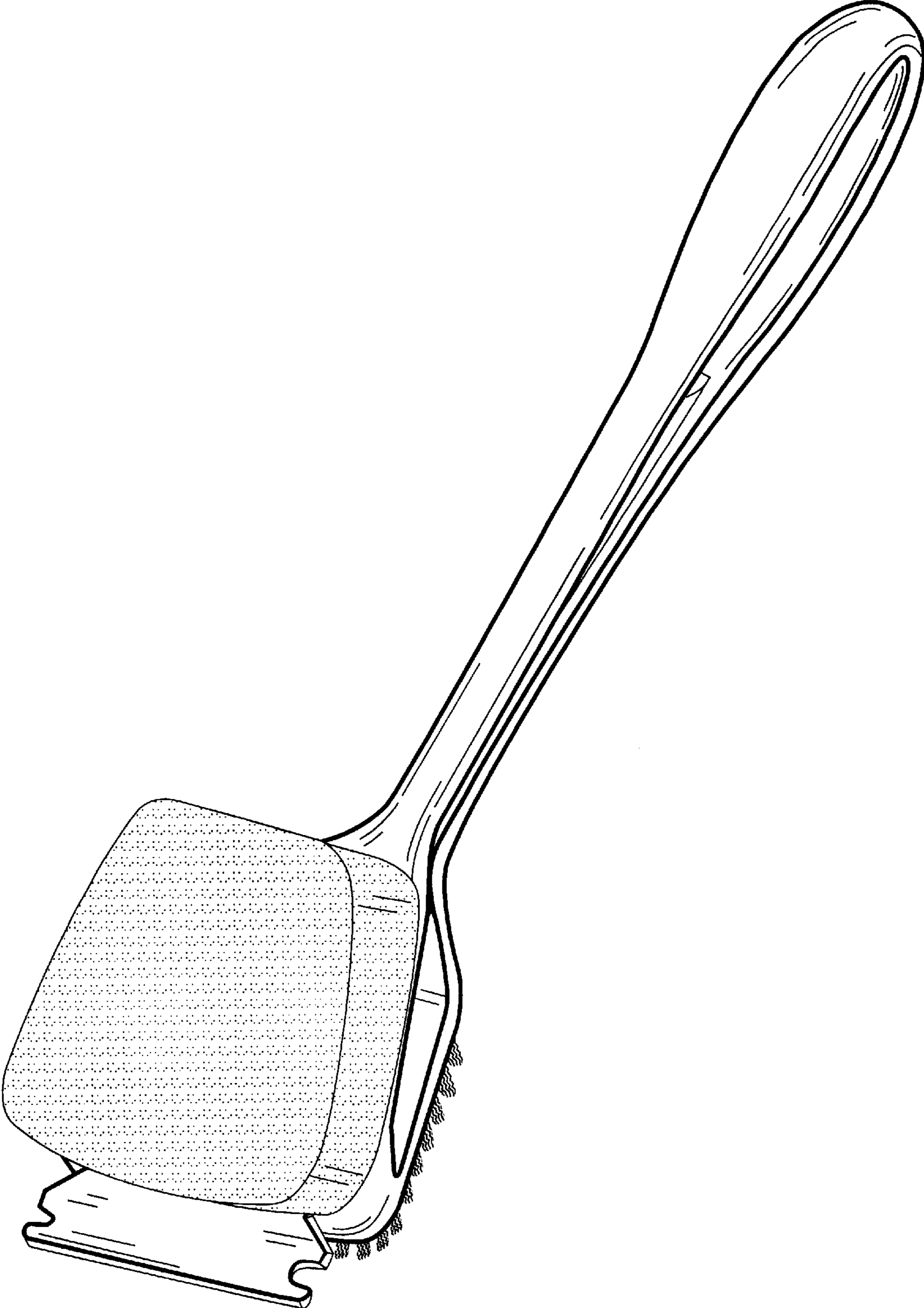

FIG:1

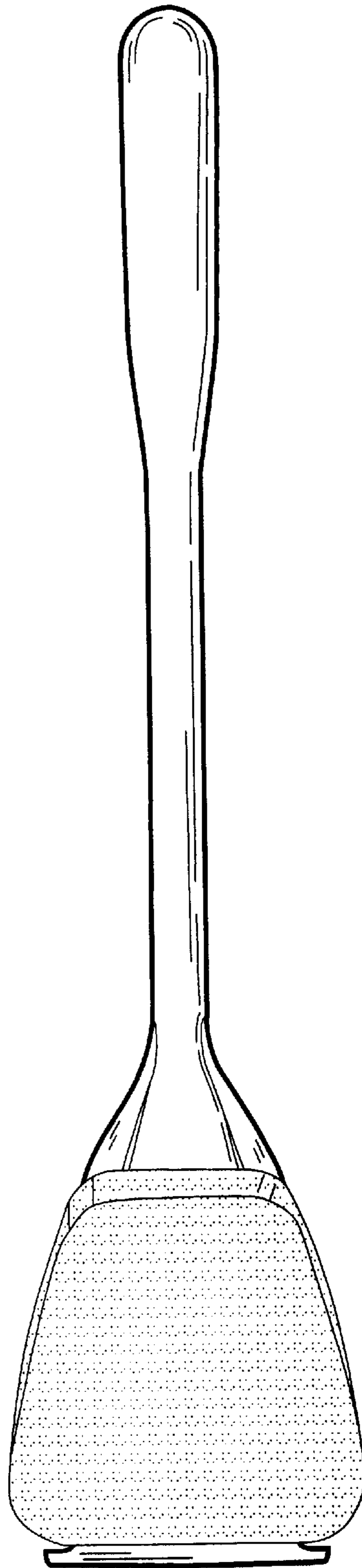

FIG:2

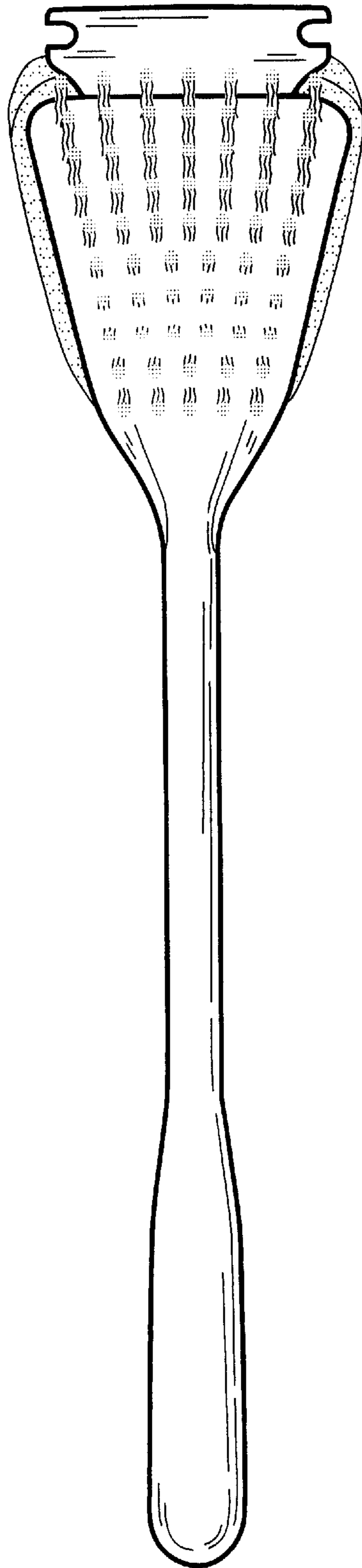

FIG:3

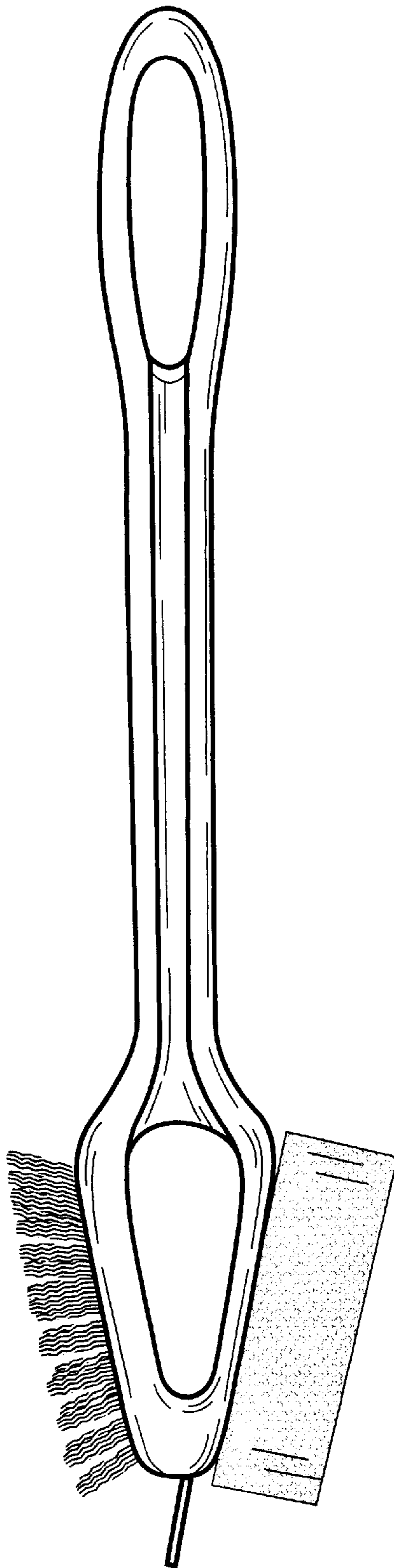

FIG:4

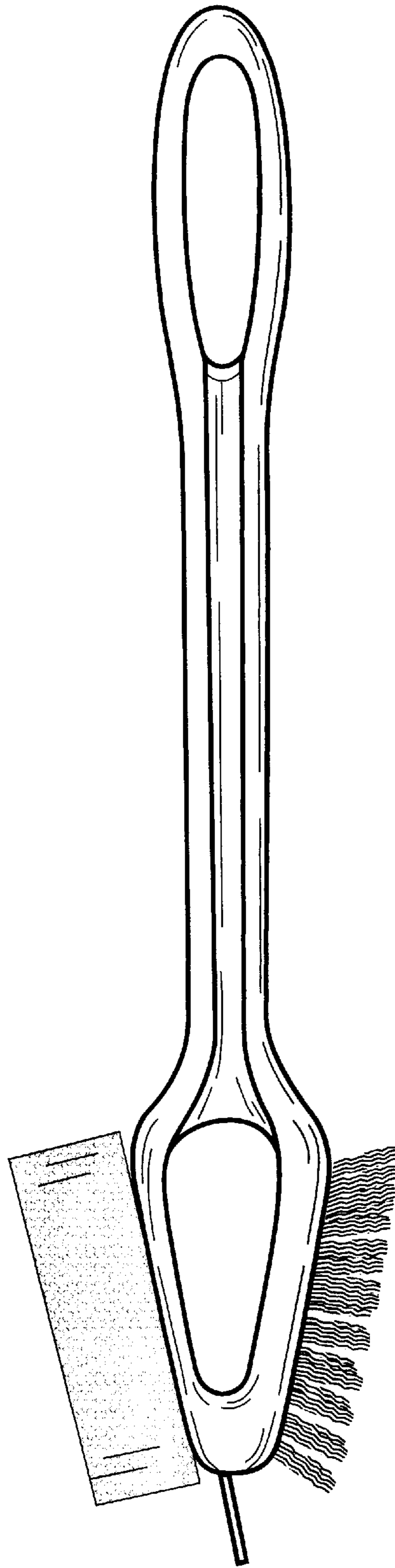

FIG:5

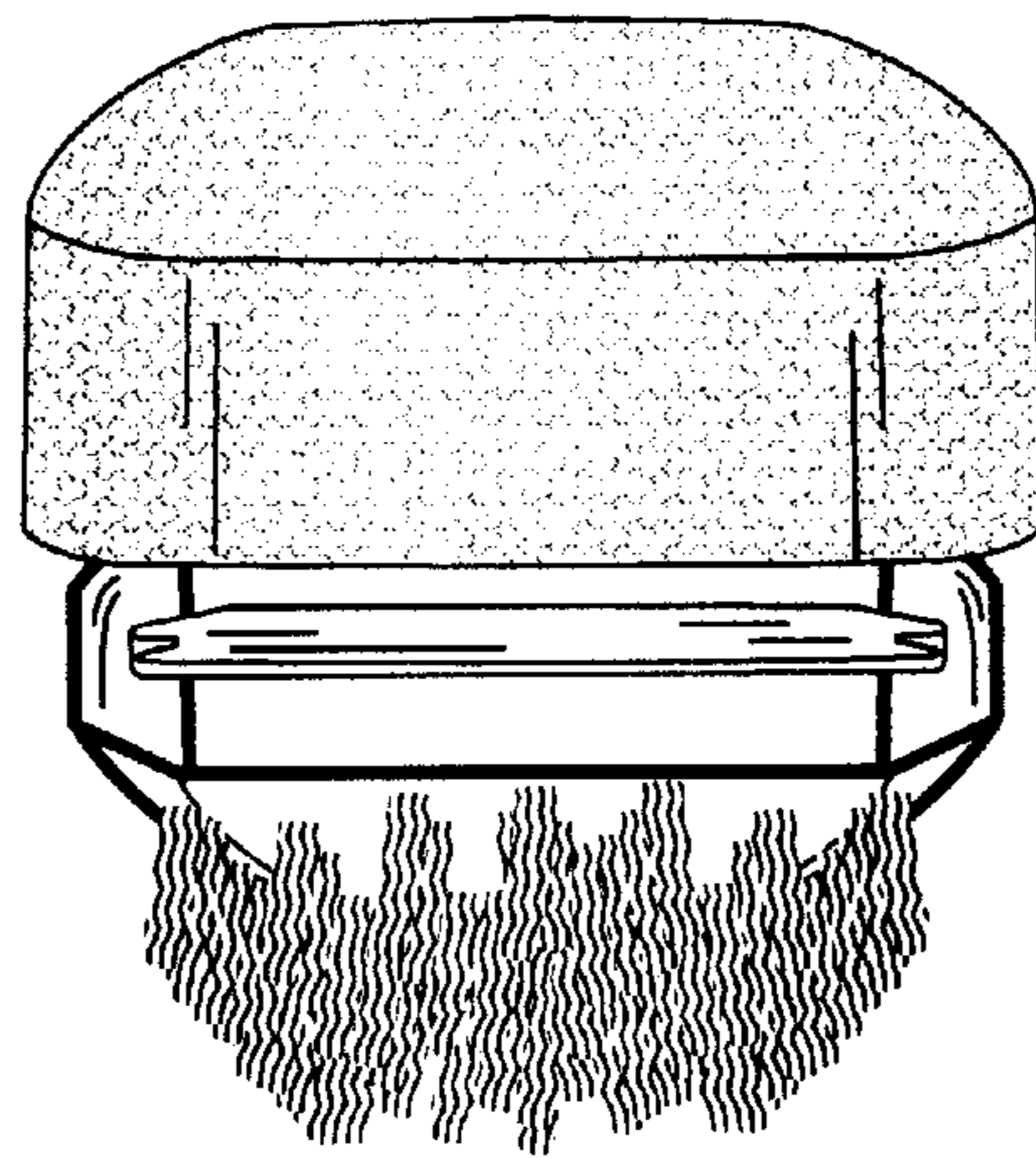

FIG:6

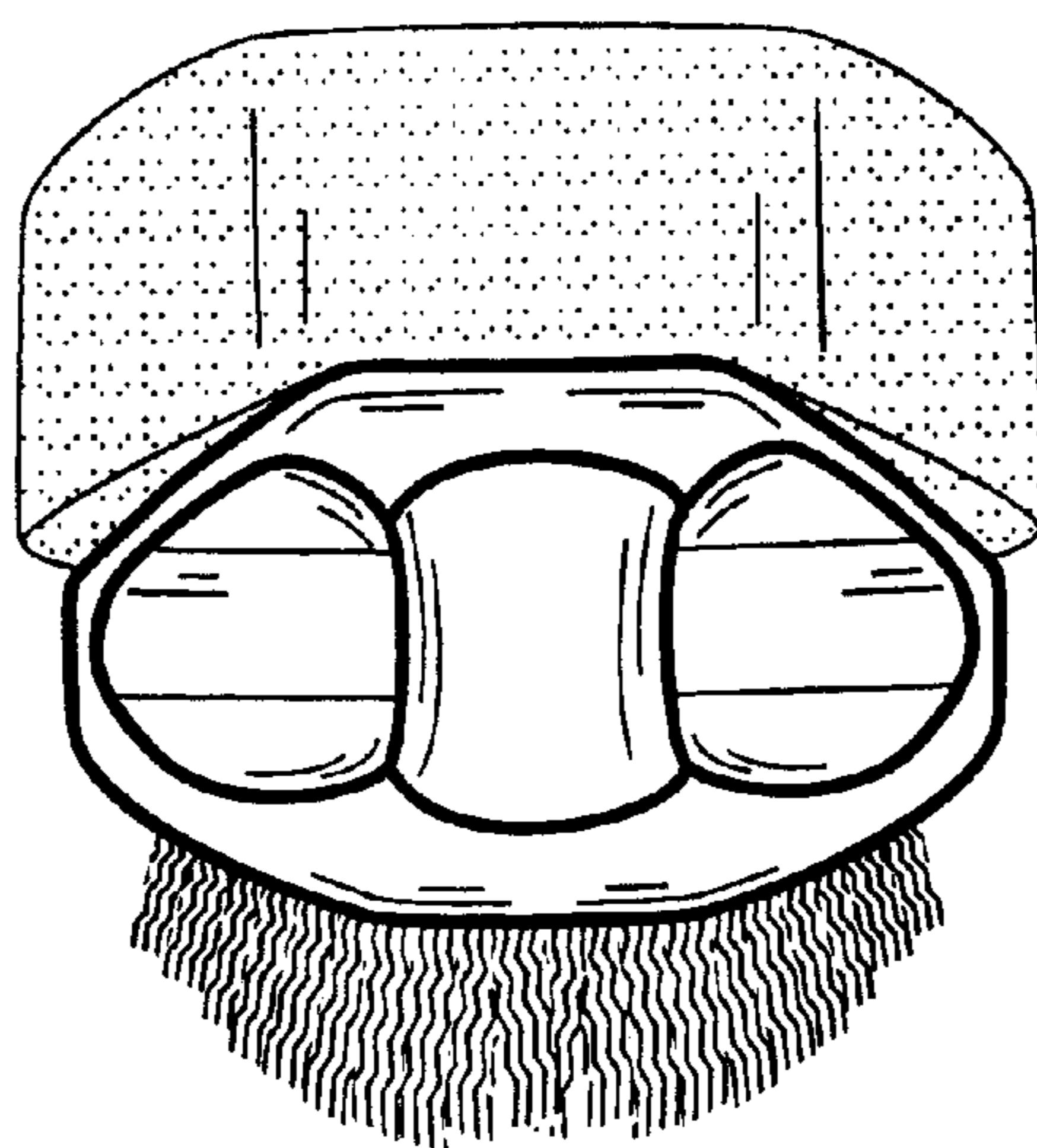

FIG:7

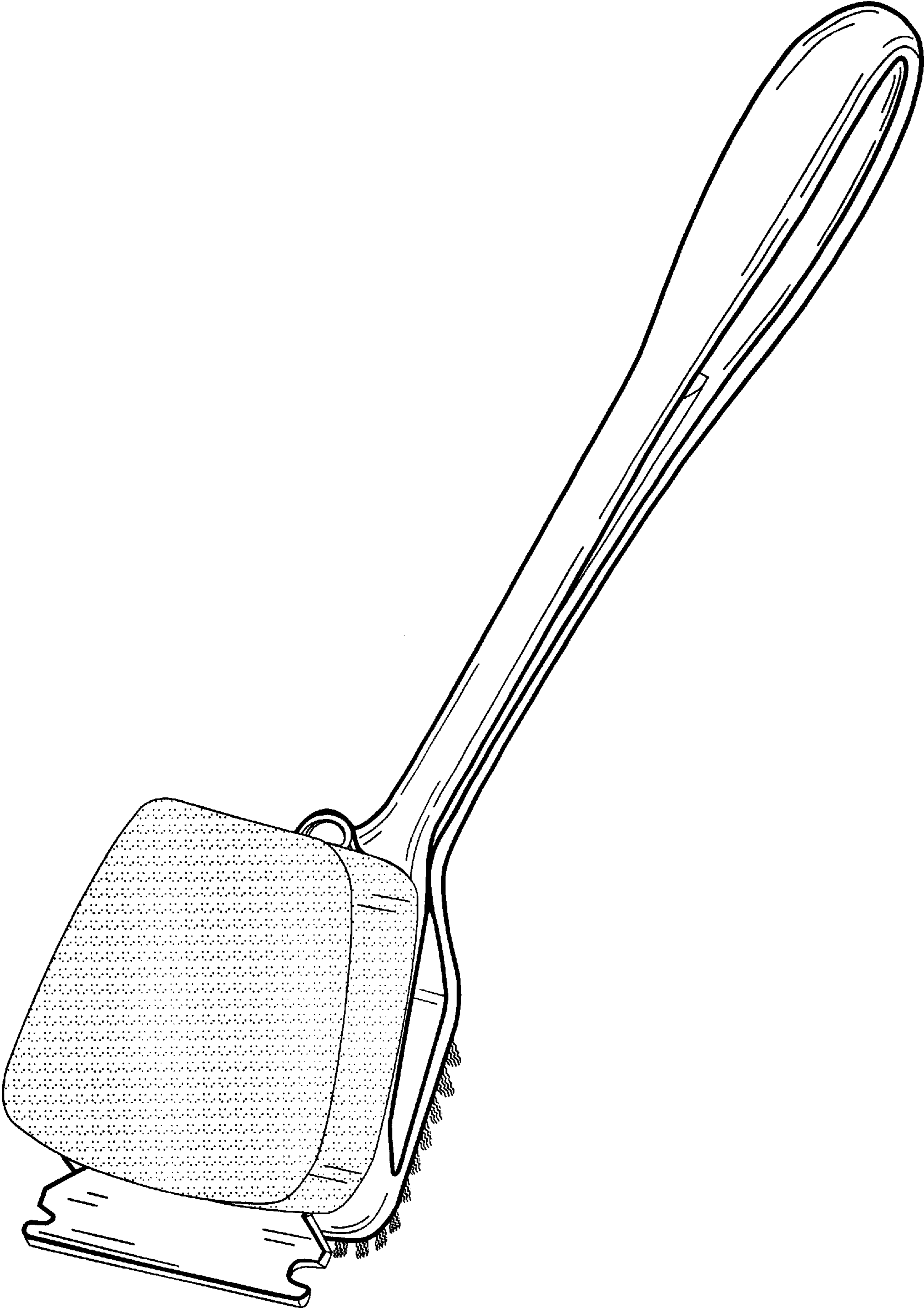

FIG:8

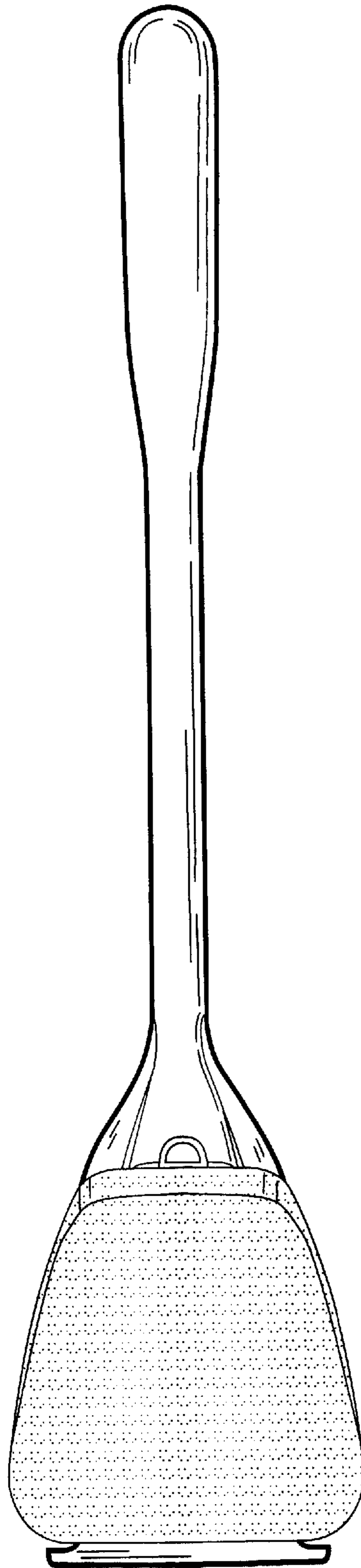

FIG:9

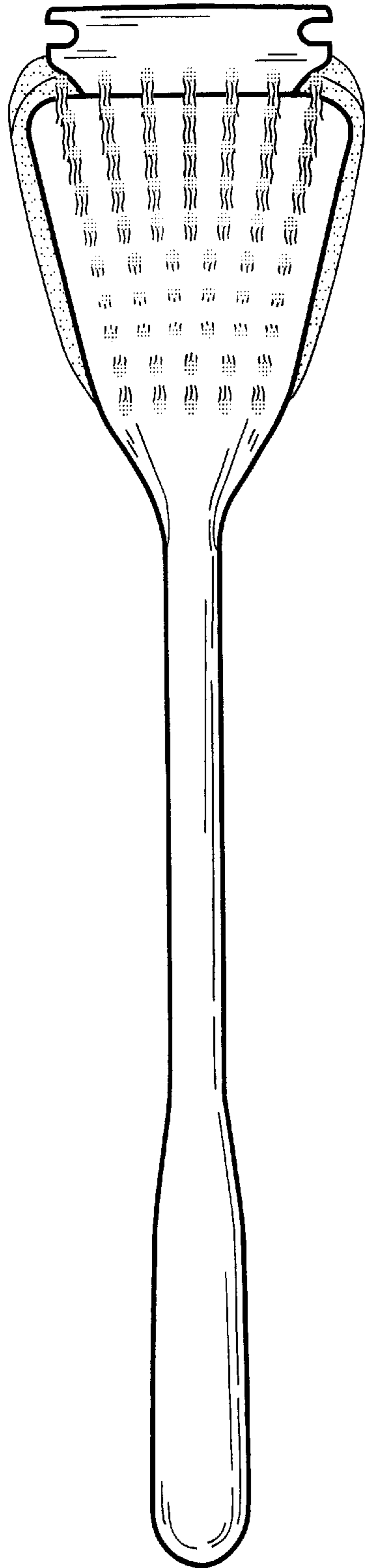

FIG:10

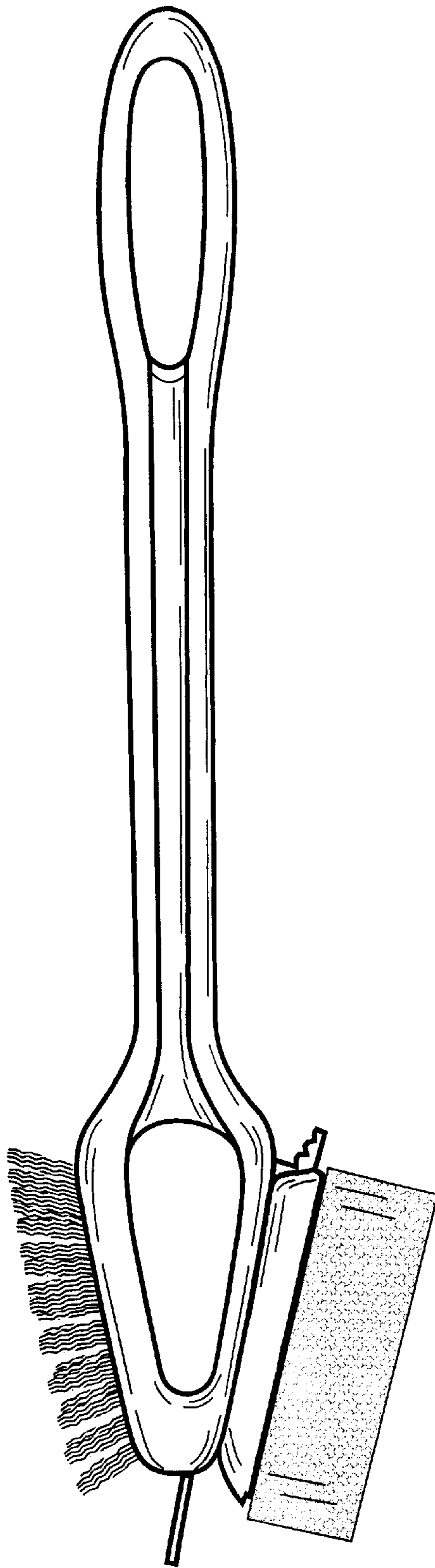

FIG:11

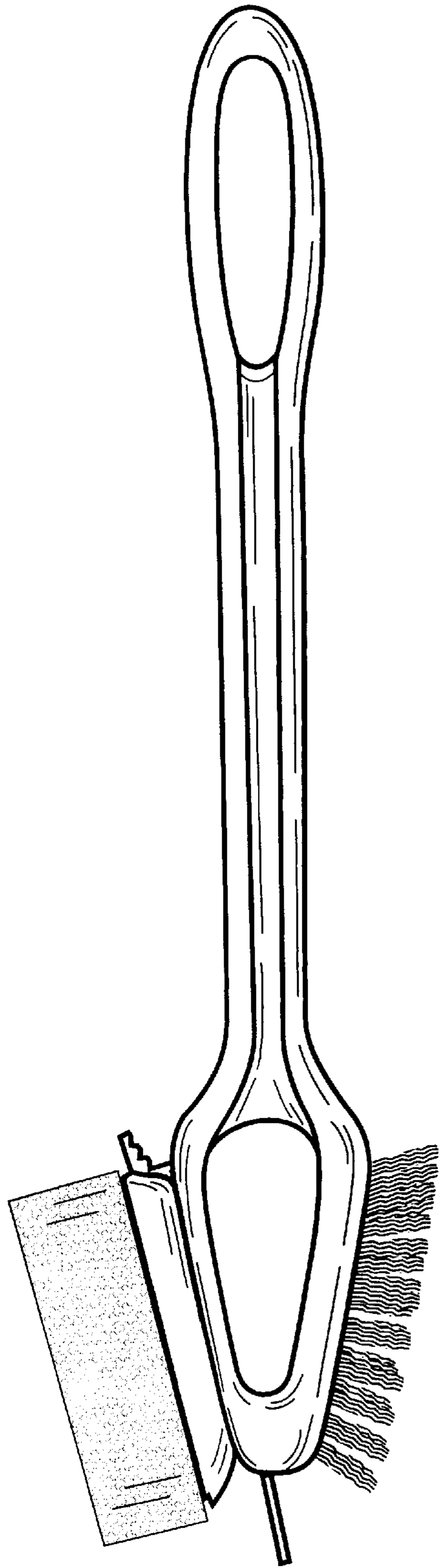

FIG:12

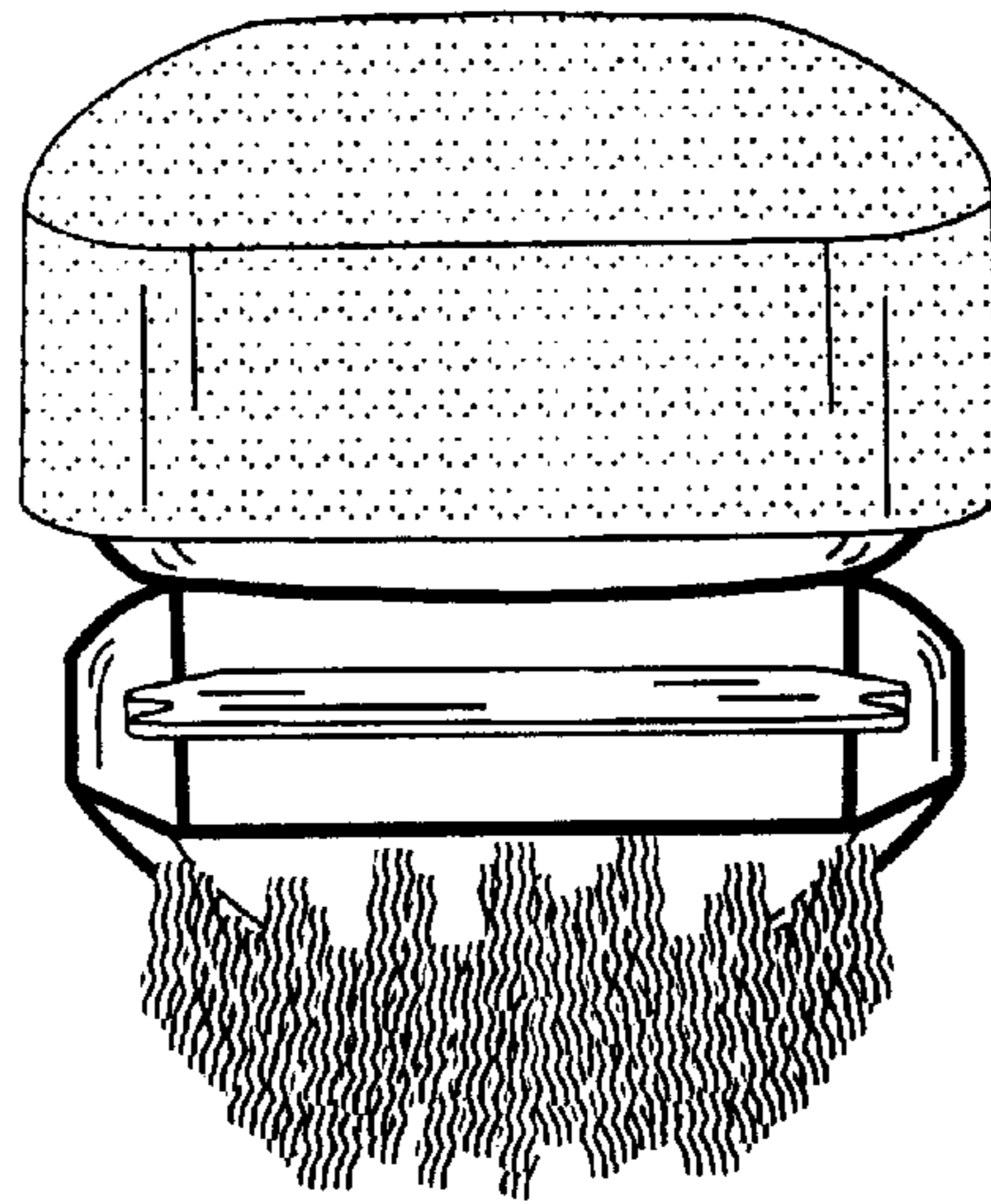

FIG:13

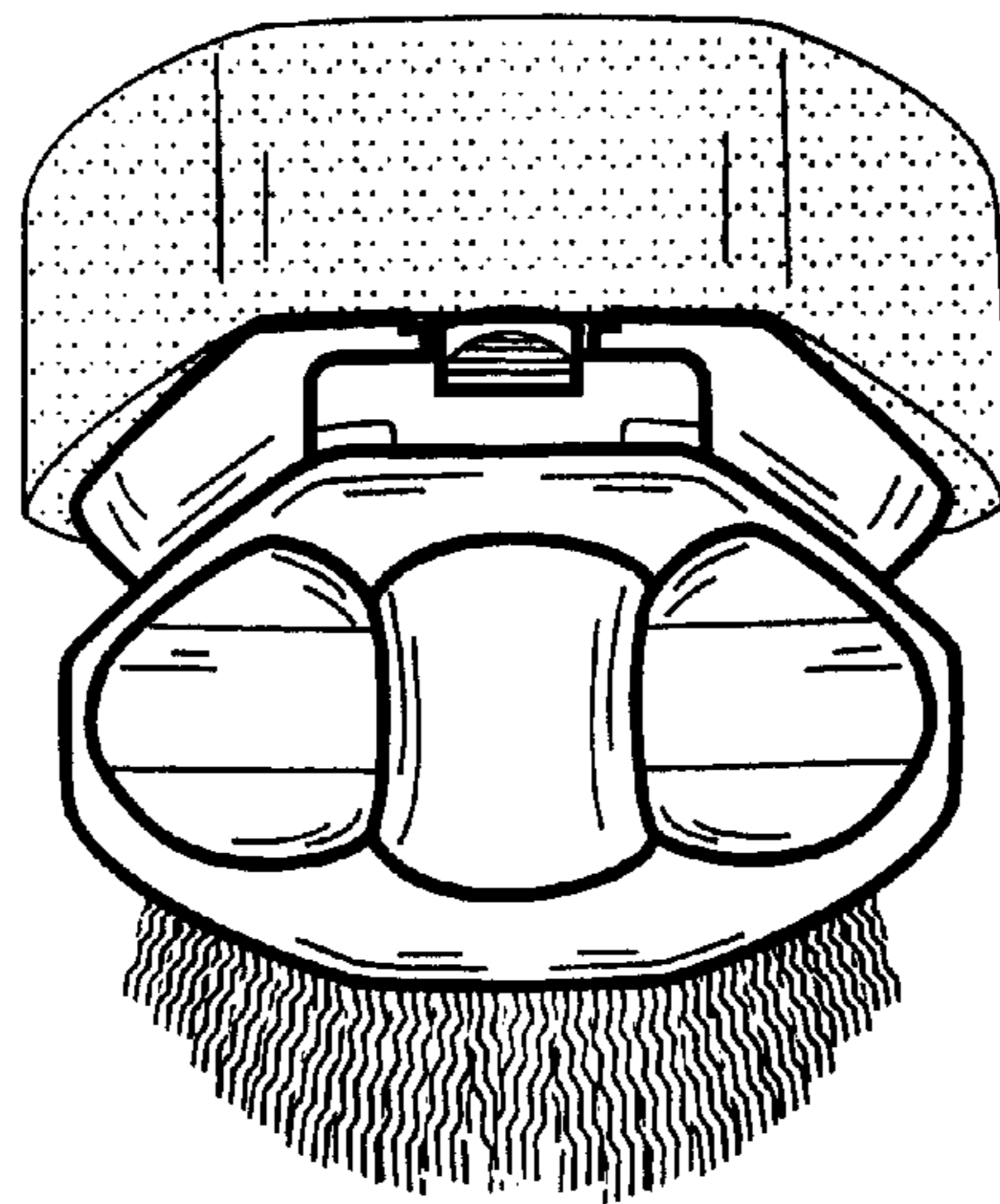

FIG:14

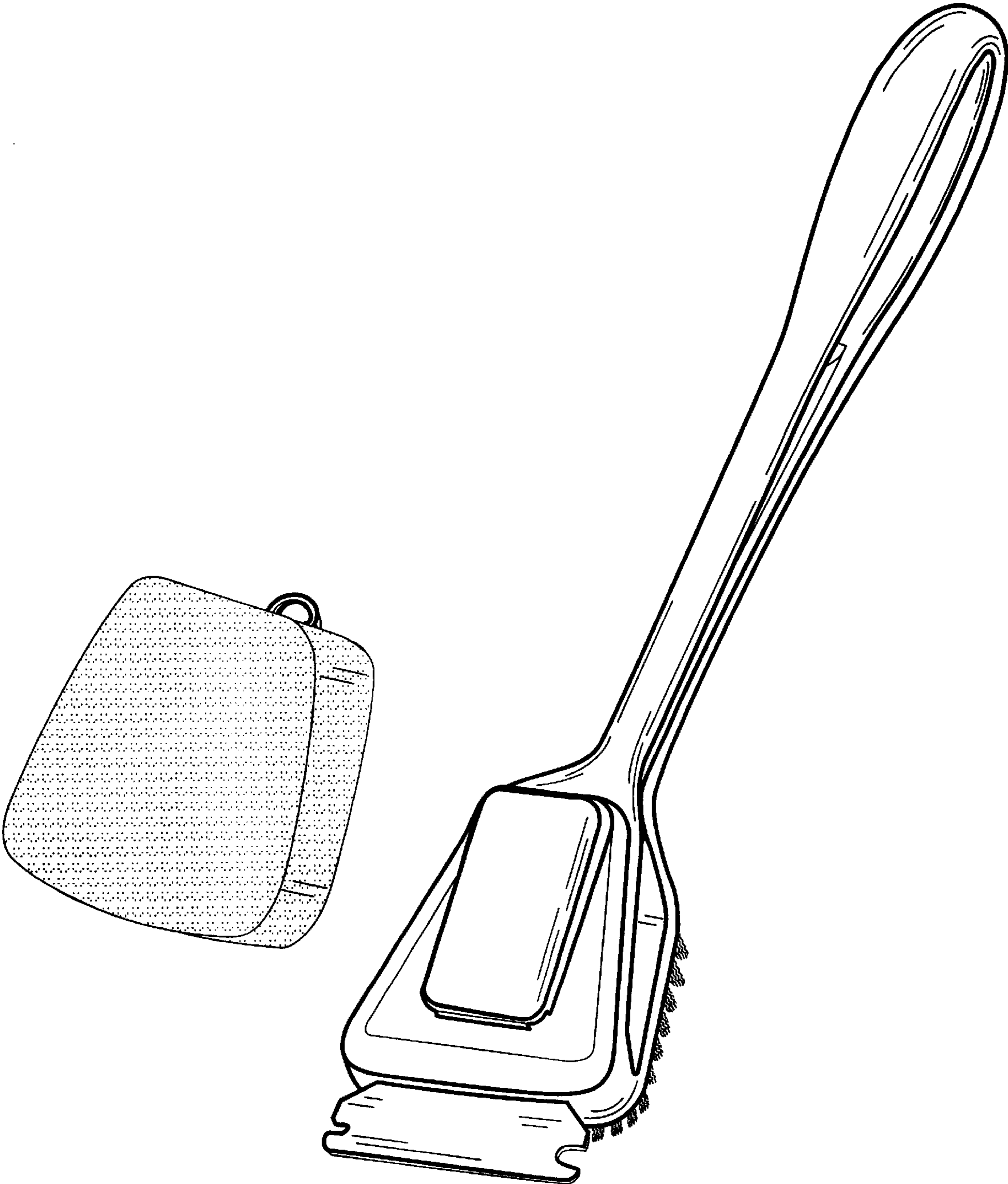

FIG:15

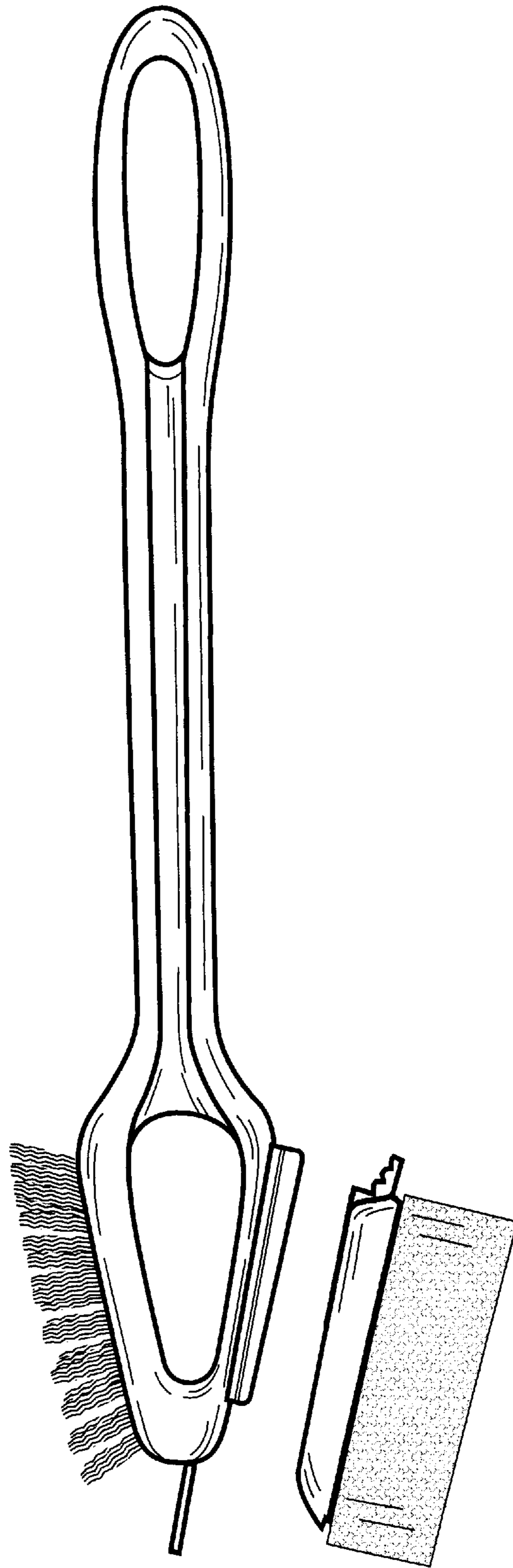

FIG:16