

US00D540276S

(12) **United States Design Patent**
Naruo

(10) **Patent No.:** **US D540,276 S**
(45) **Date of Patent:** **** Apr. 10, 2007**

(54) **TELEVISION RECEIVER**

(75) Inventor: **Mitsuru Naruo**, Daito (JP)

(73) Assignee: **Funai Electric Company Limited**,
Osaka (JP)

(**) Term: **14 Years**

(21) Appl. No.: **29/214,386**

(22) Filed: **Oct. 4, 2004**

(30) **Foreign Application Priority Data**

Apr. 2, 2004 (JP) 2004-010284

(51) **LOC (8) Cl.** **14-03**

(52) **U.S. Cl.** **D14/126**

(58) **Field of Classification Search** D14/125-135,
D14/239, 379, 371, 374, 375, 376, 113; D13/151,
D13/153; 312/7.2; 348/836, 838, 180, 184,
348/325, 739; 341/12; 248/917-924; 345/104,
345/133, 156, 168, 87, 173; 349/1, 2, 11,
349/62

See application file for complete search history.

(56) **References Cited**

U.S. PATENT DOCUMENTS

D423,477 S * 4/2000 Usui D14/375

D425,035 S * 5/2000 Kondo et al. D14/375
D472,532 S * 4/2003 Niitsu D14/126
D482,339 S * 11/2003 Yin et al. D14/134
D483,360 S * 12/2003 Ma D14/371
D492,271 S * 6/2004 Esslinger et al. D14/129
D497,351 S * 10/2004 Kita D14/126
D501,451 S * 2/2005 Harata D14/126
D503,159 S * 3/2005 Esslinger et al. D14/129
D523,831 S * 6/2006 Brunner et al. D14/126

* cited by examiner

Primary Examiner—Raphael Barkai

Assistant Examiner—Randall H. Gholson

(74) *Attorney, Agent, or Firm*—Sughrue Mion, PLLC

(57) **CLAIM**

The ornamental design for a television receiver, as shown.

DESCRIPTION

FIG. 1 is a perspective view of the front and right side of a television receiver showing my new design; FIG. 2 is a front elevational view thereof; FIG. 3 is a rear elevational view thereof; FIG. 4 is a right side elevational view thereof; FIG. 5 is a left side elevational view thereof; FIG. 6 is a top plan view thereof; and, FIG. 7 is a bottom plan view thereof.

1 Claim, 6 Drawing Sheets

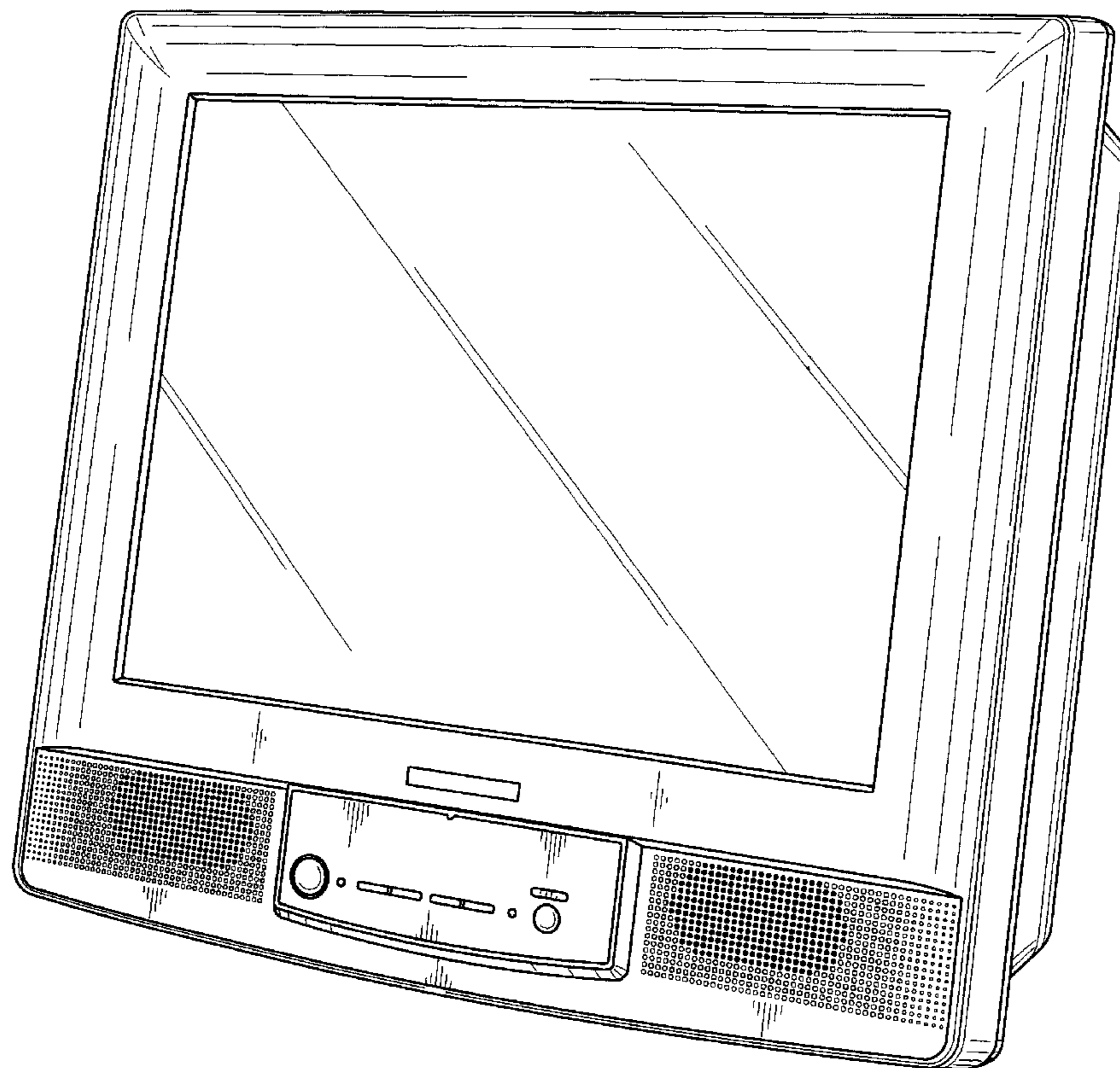

FIG. 1

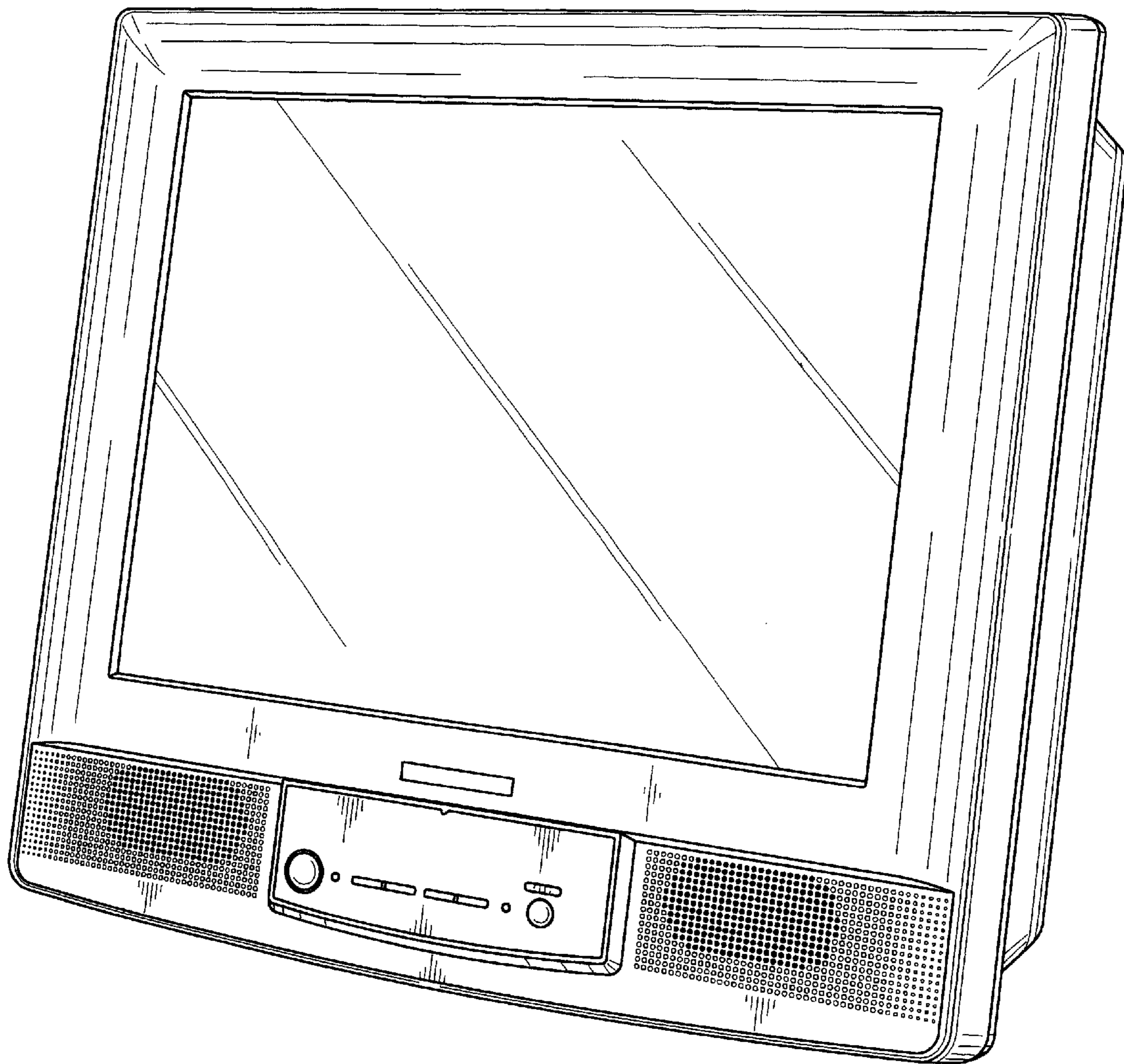

FIG. 2

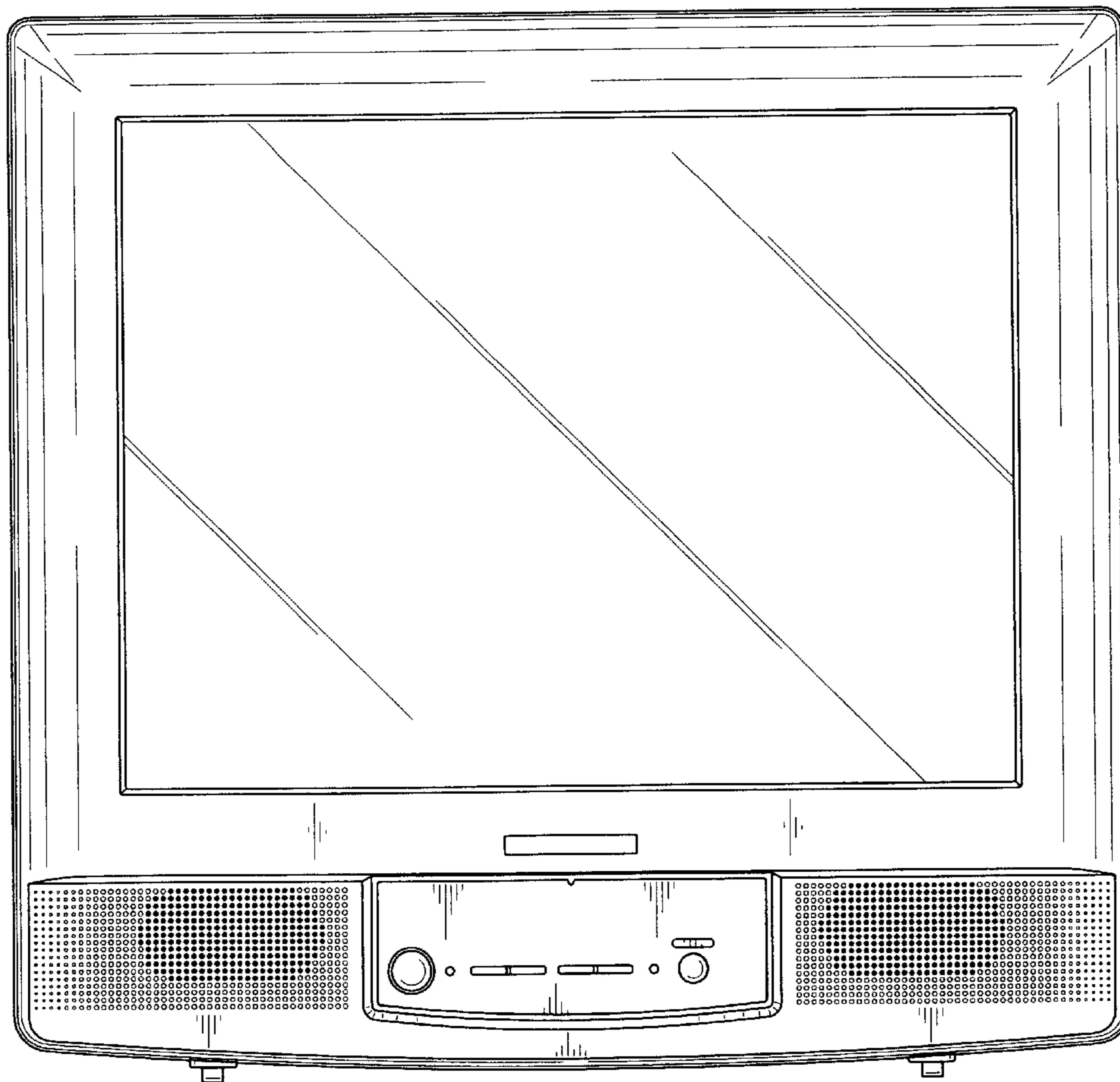

FIG. 3

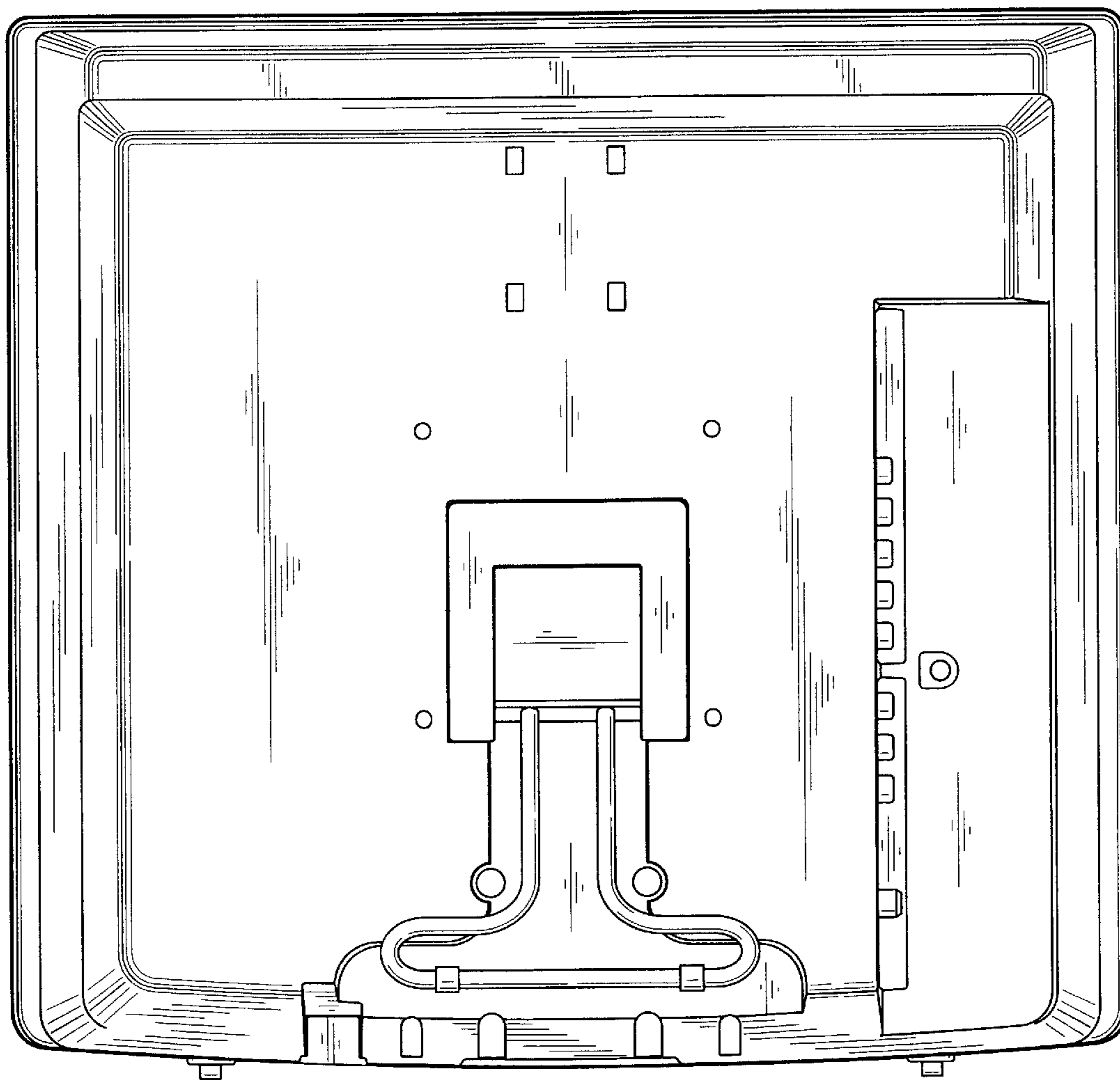

FIG. 4

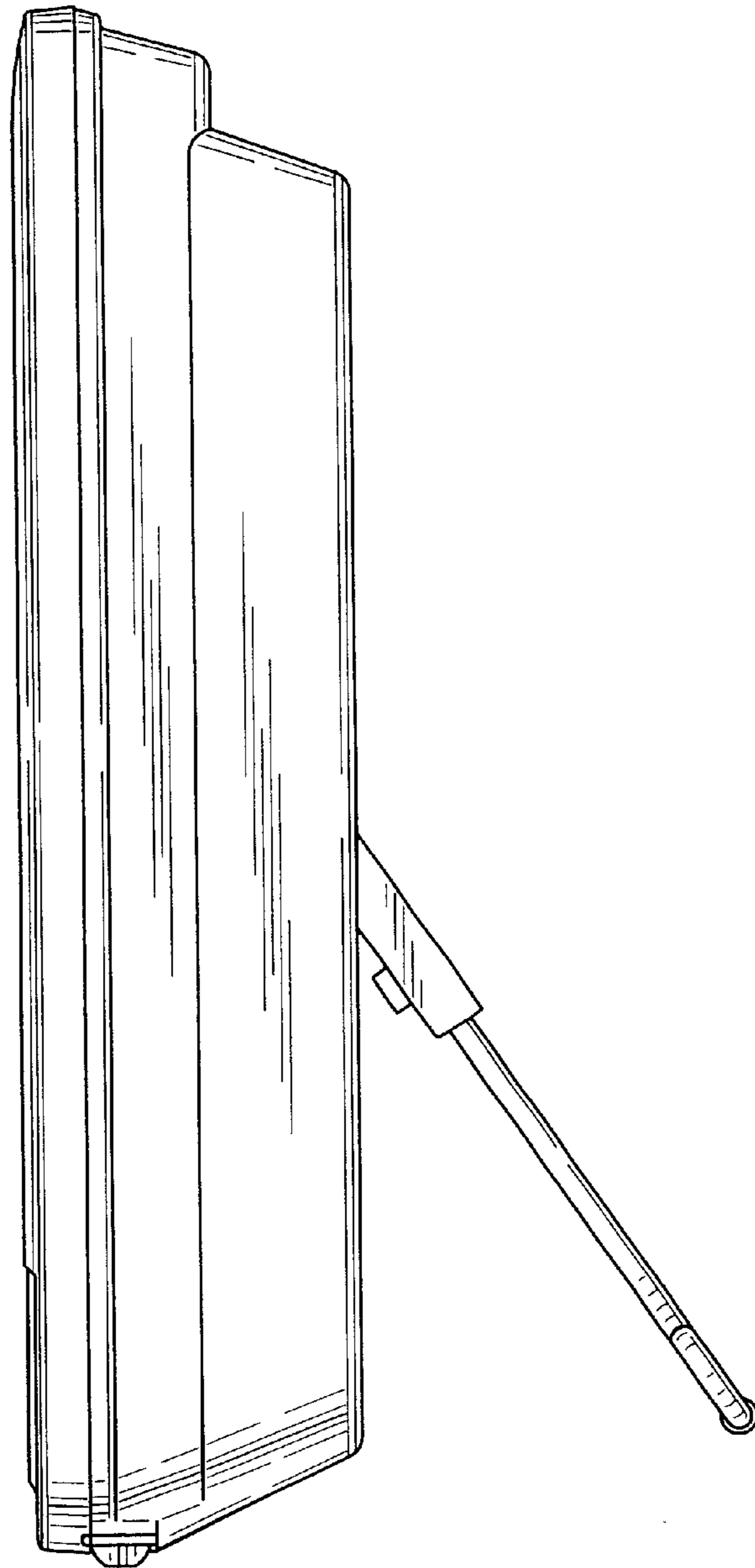

FIG. 5

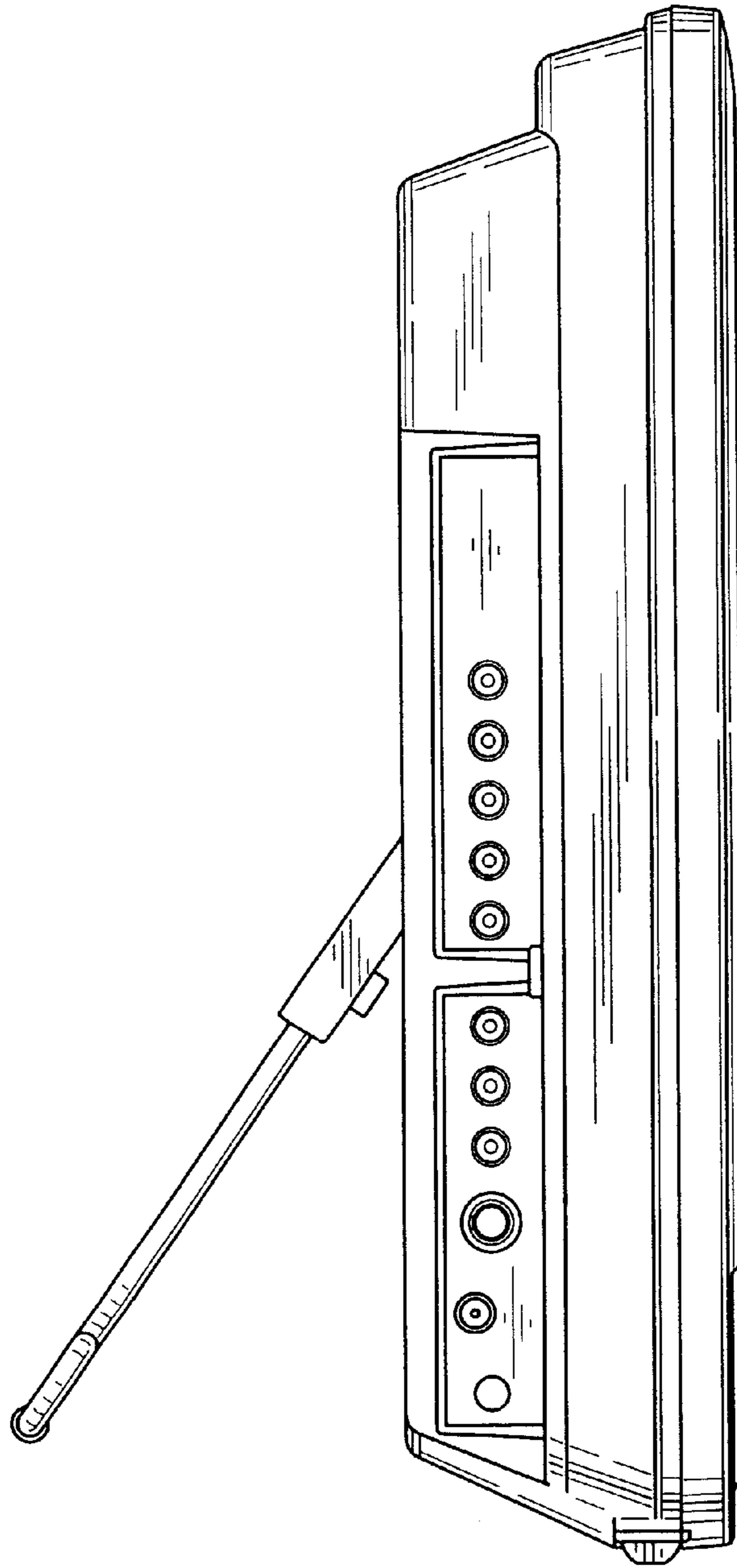

FIG. 6

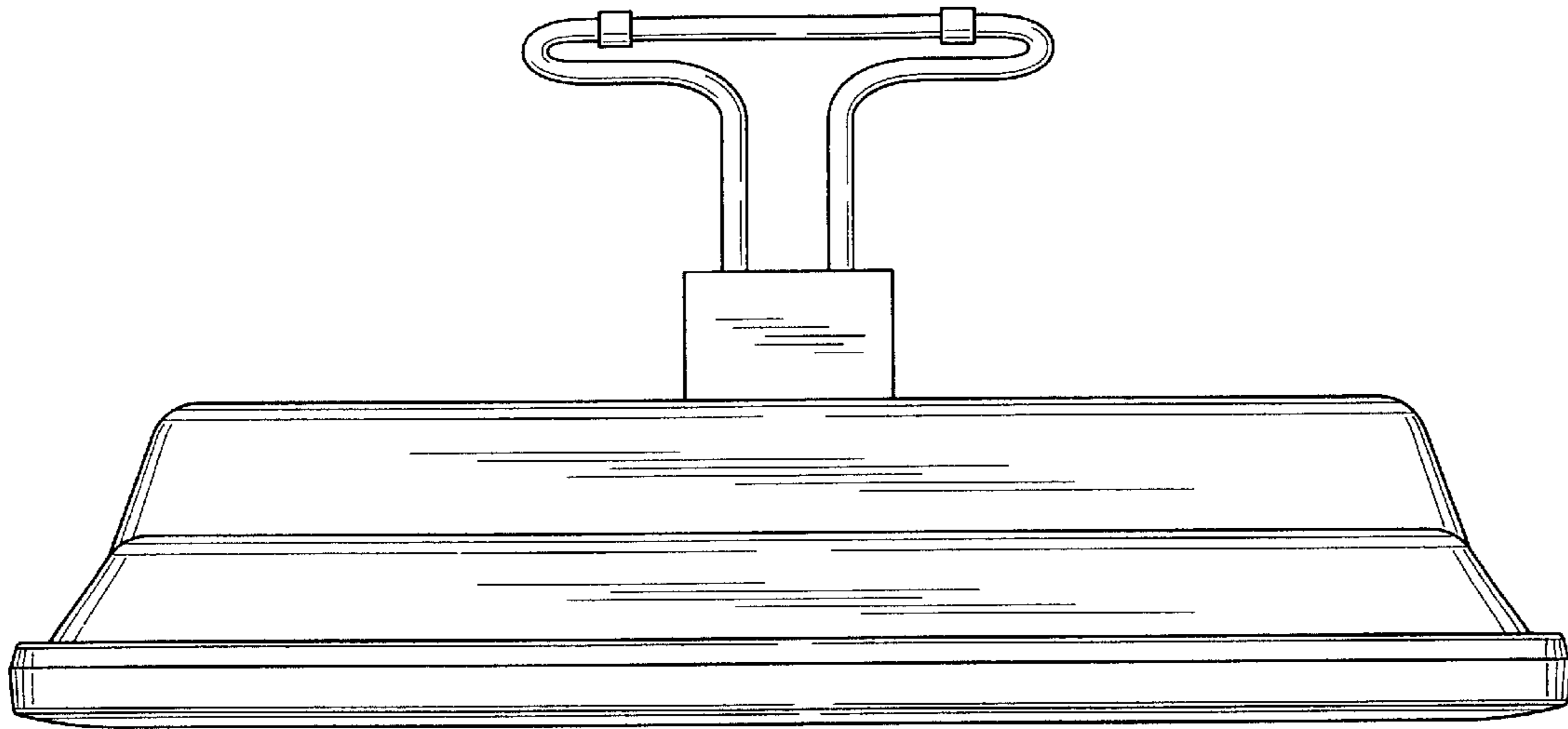

FIG. 7

