

US00D540266S

(12) **United States Design Patent**
Mayo et al.

(10) **Patent No.:** **US D540,266 S**
(45) **Date of Patent:** **** Apr. 10, 2007**

(54) **SWITCH**

(75) Inventors: **Noel Mayo**, Philadelphia, PA (US);
Elliot G. Jacoby, Glenside, PA (US);
Paul A. Larson, Macungie, PA (US);
Joel S. Spira, Coopersburg, PA (US)

(73) Assignee: **Lutron Electronics Co., Inc.**,
Coopersburg, PA (US)

(**) Term: **14 Years**

(21) Appl. No.: **29/214,397**

(22) Filed: **Oct. 1, 2004**

(51) **LOC (8) Cl.** **13-03**

(52) **U.S. Cl.** **D13/162; D13/171**

(58) **Field of Classification Search** D13/162,
D13/164, 169, 170, 171; D10/108, 116, 118;
D8/353; 200/5 A, 293, 296, 297, 329, 333,
200/335, 339, 341, 520, 530, 537, 552; 220/241;
307/125, 139; 315/291-296

See application file for complete search history.

(56) **References Cited**

U.S. PATENT DOCUMENTS

D249,141 S	*	8/1978	Mayo	D13/125
D329,635 S	*	9/1992	Tsai	D13/110
D440,207 S	*	4/2001	Carson et al.	D13/162
6,533,551 B2	*	3/2003	Escobar et al.	416/244 R
6,710,274 B2	*	3/2004	Whetzel et al.	200/330
6,774,328 B2	*	8/2004	Adams et al.	200/329
D517,503 S	*	3/2006	Mayo et al.	D13/171
D522,464 S	*	6/2006	Mayo et al.	D13/171
2003/0089587 A1	*	5/2003	Mayo et al.	200/329

* cited by examiner

Primary Examiner—Selina Sikder

(74) *Attorney, Agent, or Firm*—Drinker Biddle & Reath
LLP

(57) **CLAIM**

The ornamental design for a switch, as shown and described.

DESCRIPTION

FIG. 1 is a front perspective view of a switch showing a first embodiment of our new design.

FIG. 2 is a front elevation view thereof.

FIG. 3 is a left side view thereof.

FIG. 4 is a right side view thereof.

FIG. 5 is a bottom view thereof.

FIG. 6 is a top view thereof.

FIG. 7 is a front perspective view of a switch according to a second embodiment of the design shown in FIG. 1.

FIG. 8 is a front elevation view thereof.

FIG. 9 is a left side view thereof.

FIG. 10 is a right side view thereof.

FIG. 11 is a bottom view thereof.

FIG. 12 is a top view thereof.

FIG. 13 is a front perspective view of a switch according to third embodiment of the design shown in FIG. 1.

FIG. 14 is a front elevation view thereof.

FIG. 15 is a left side view thereof.

FIG. 16 is a right side view thereof.

FIG. 17 is a bottom view thereof.

FIG. 18 is a top view thereof.

FIG. 19 is a front perspective view of a switch according to a fourth embodiment of the design shown in FIG. 1.

FIG. 20 is a front elevation view thereof, the left side, right side, bottom and top views being identical to those of the third embodiment.

FIG. 21 is a front perspective view of a switch according to a fifth embodiment of the design shown in FIG. 1.

FIG. 22 is a front elevation view thereof.

FIG. 23 is a left side view thereof.

FIG. 24 is a right side view thereof.

FIG. 25 is a bottom view thereof.

FIG. 26 is a top view thereof.

FIG. 27 is a front perspective view of a switch according to an sixth embodiment of the design shown in FIG. 1; and,

FIG. 28 is a front elevation view thereof, the left side, right side, bottom and top views being identical to those of the fifth embodiment.

The portions of the drawing appearing in broken line are for environment only and do not form a part of the design.

1 Claim, 20 Drawing Sheets

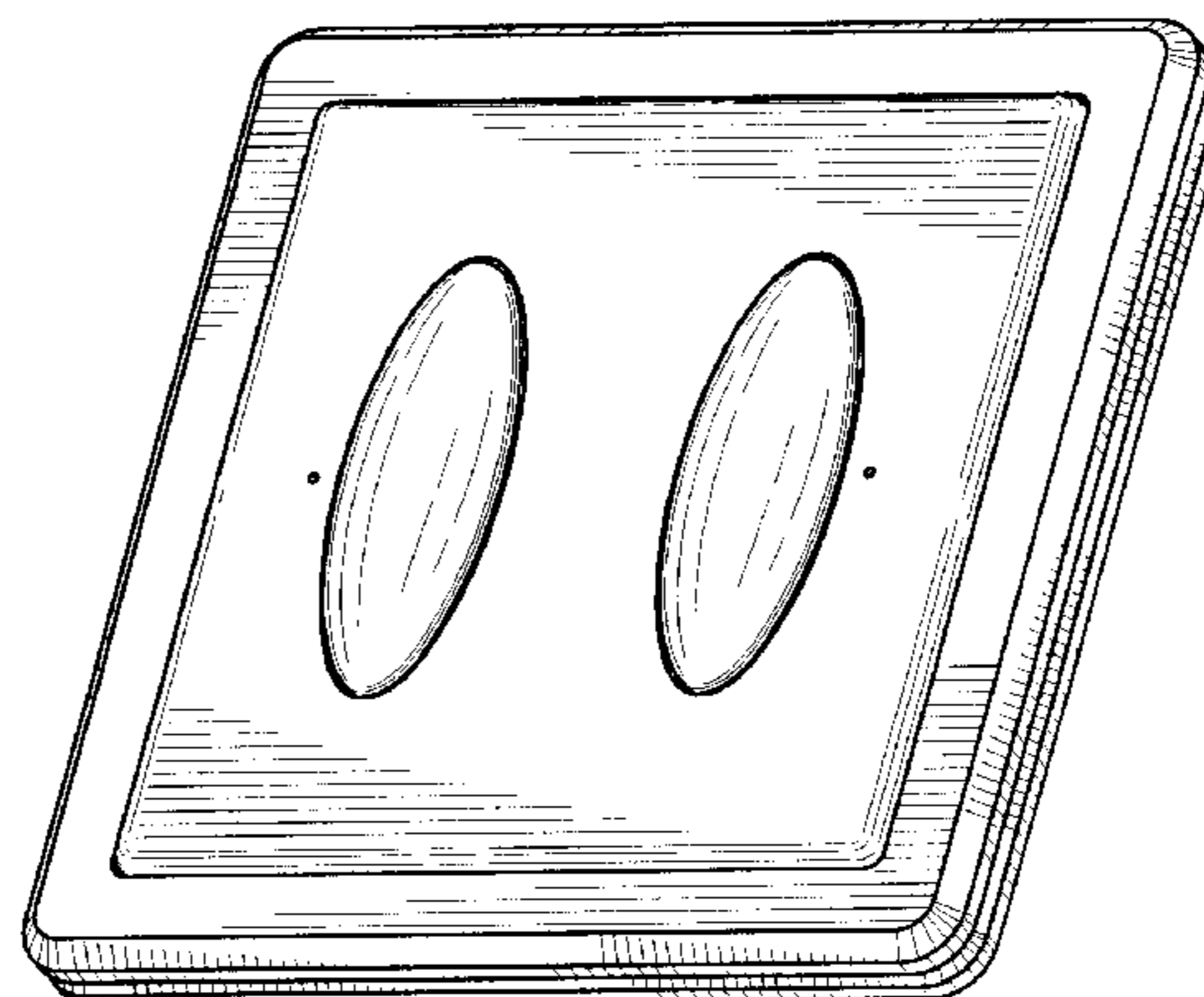
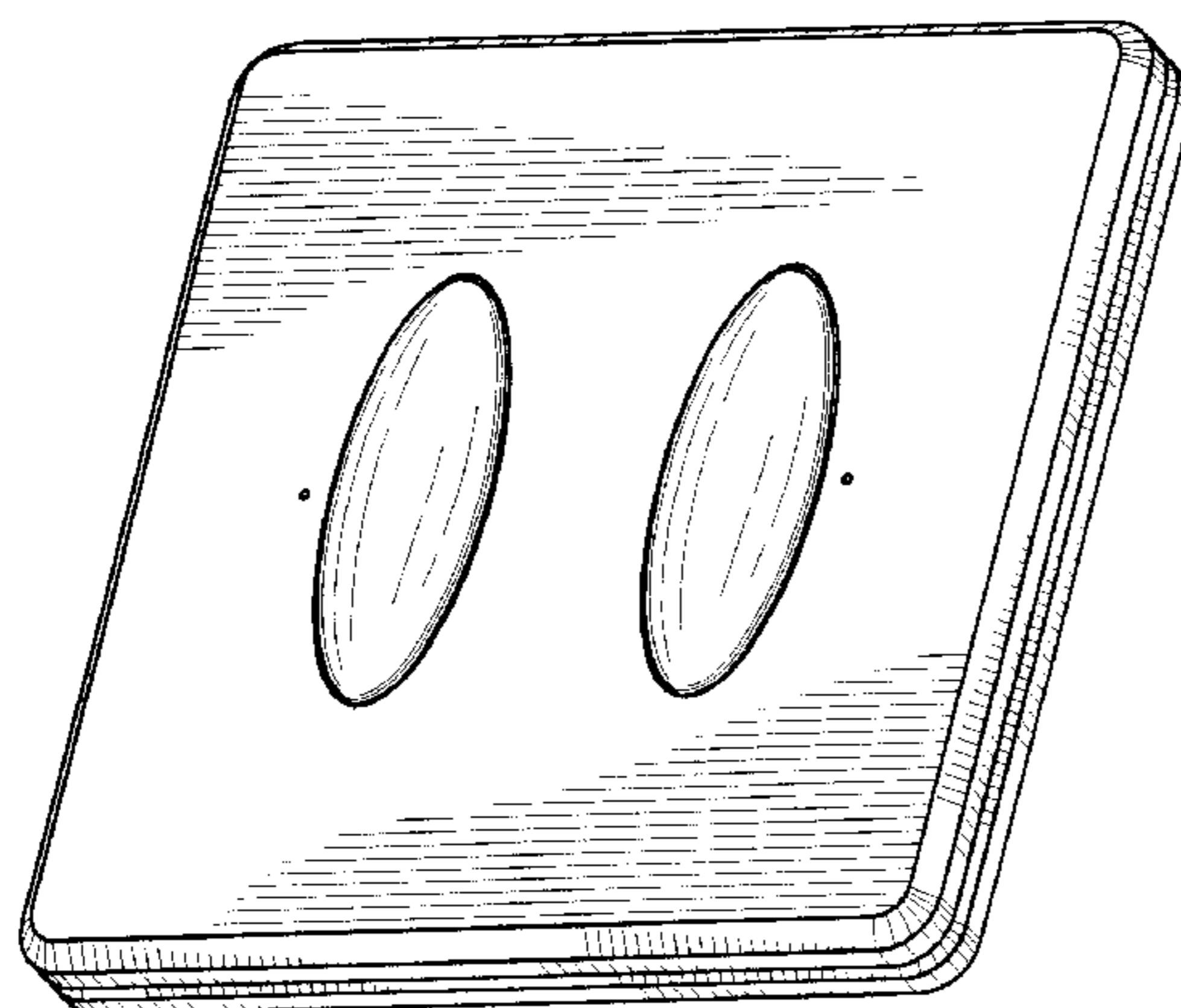

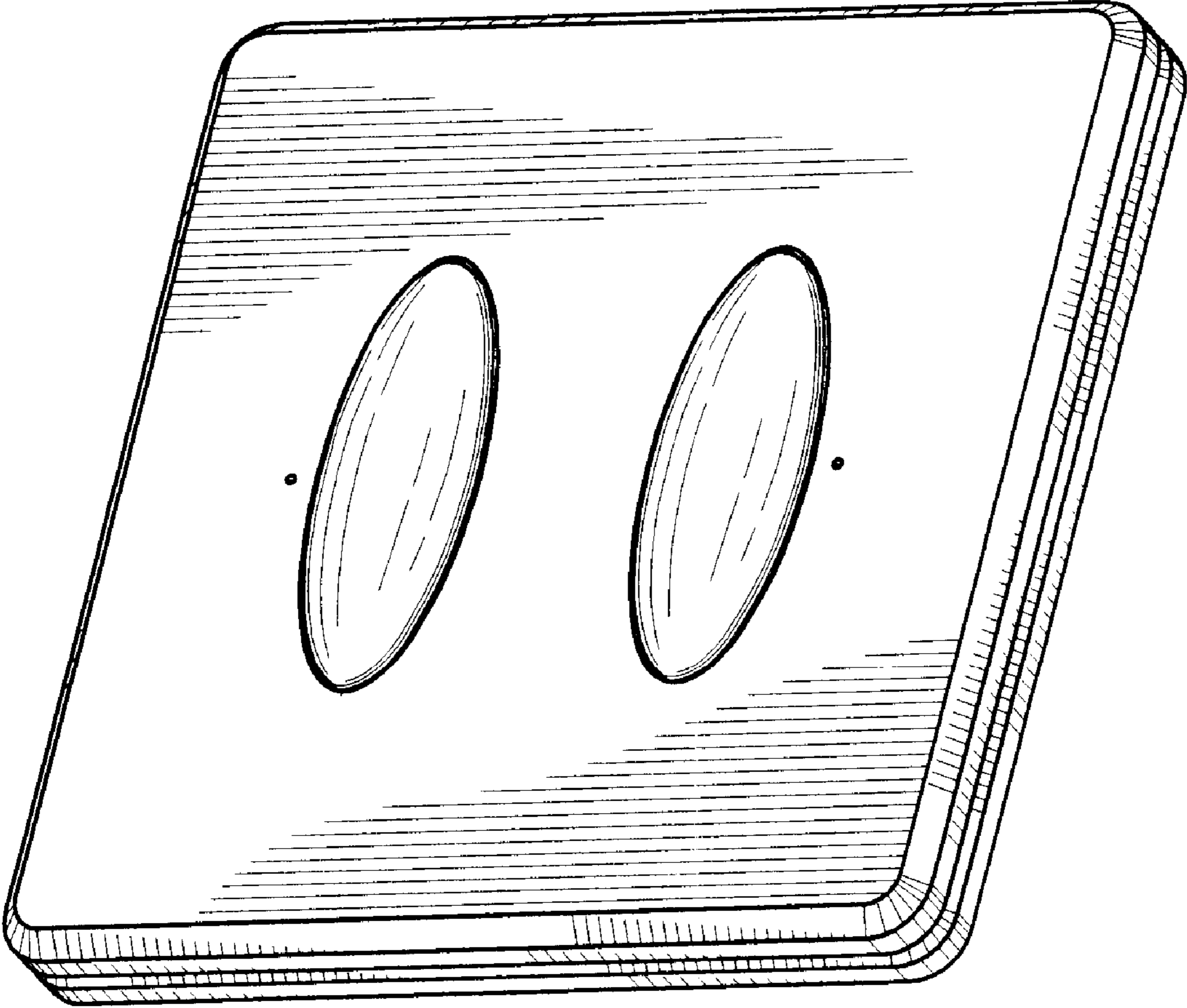

FIG. 1

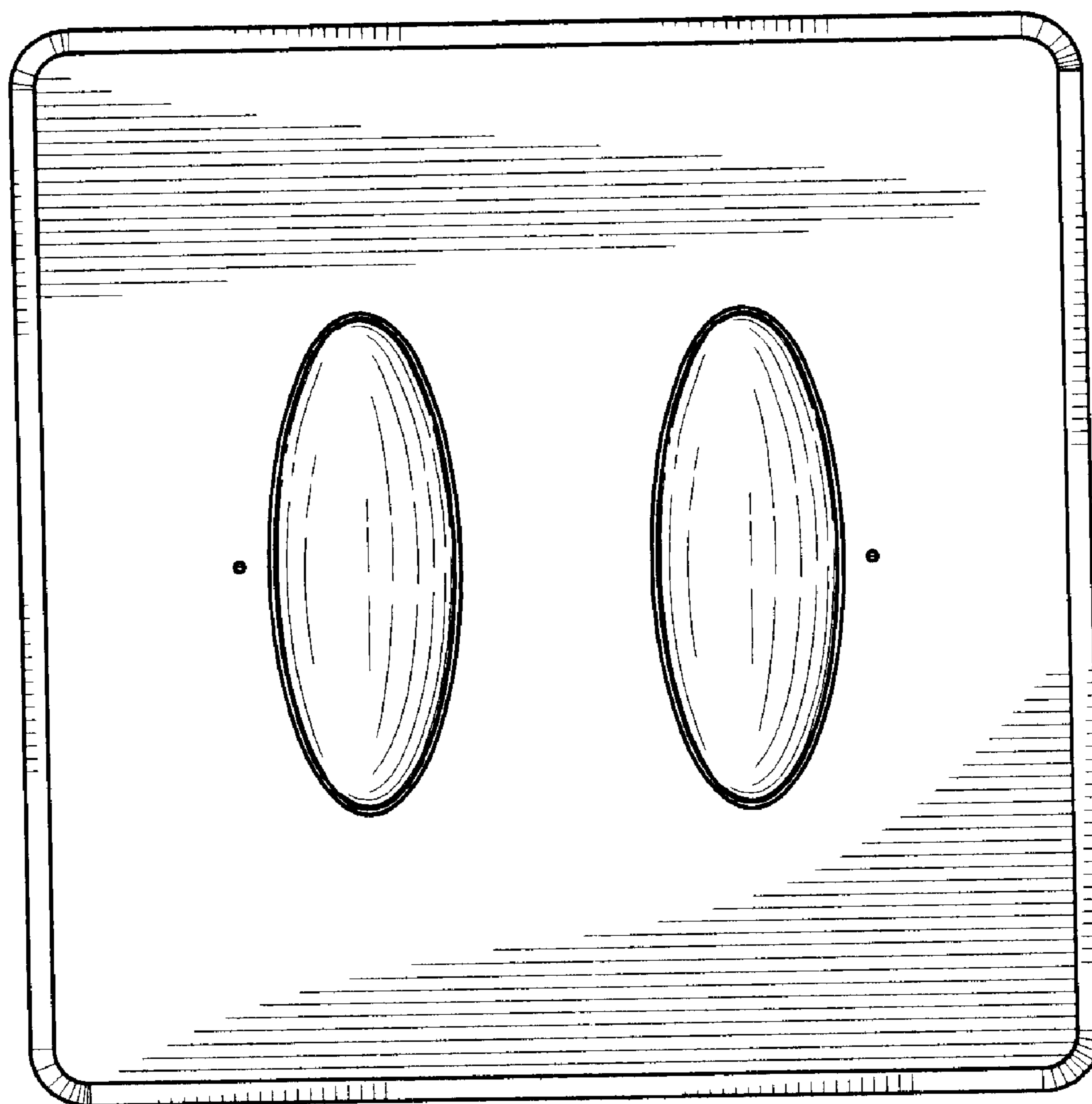

FIG. 2

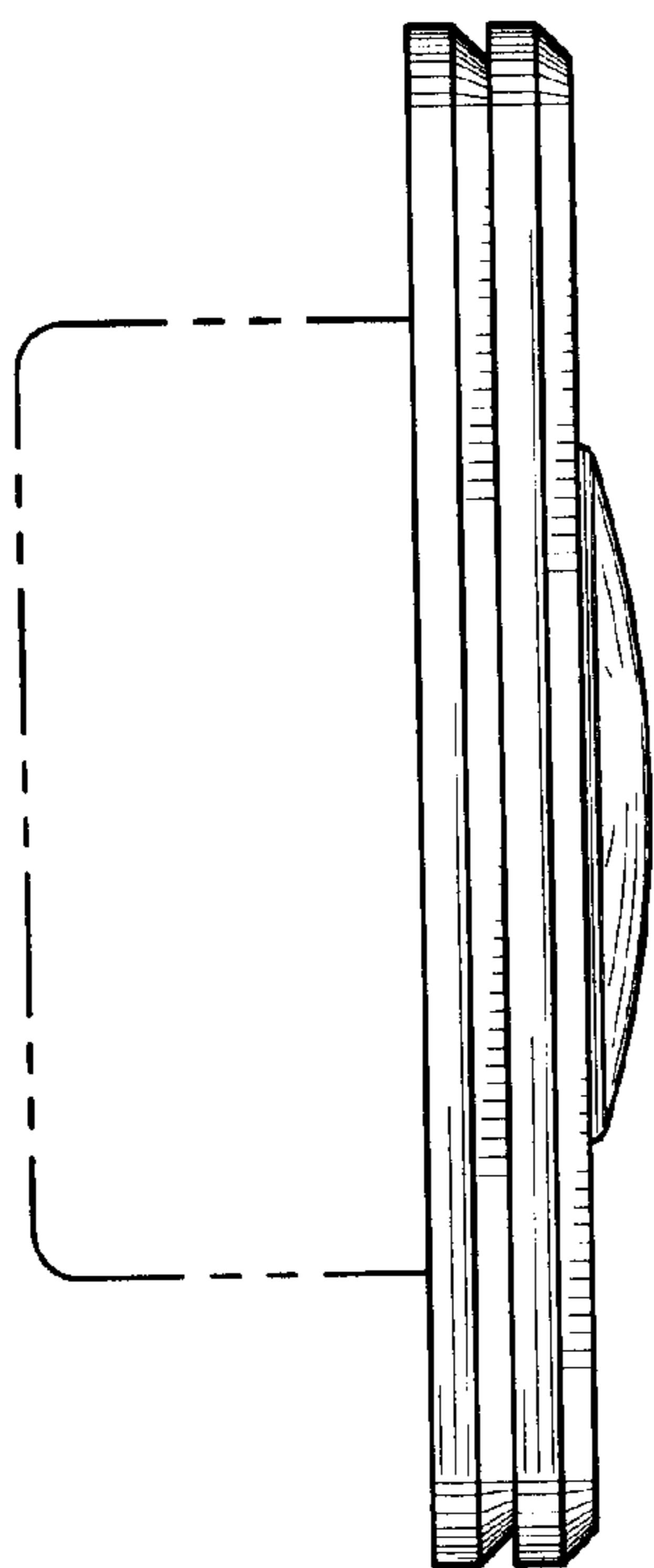

FIG. 3

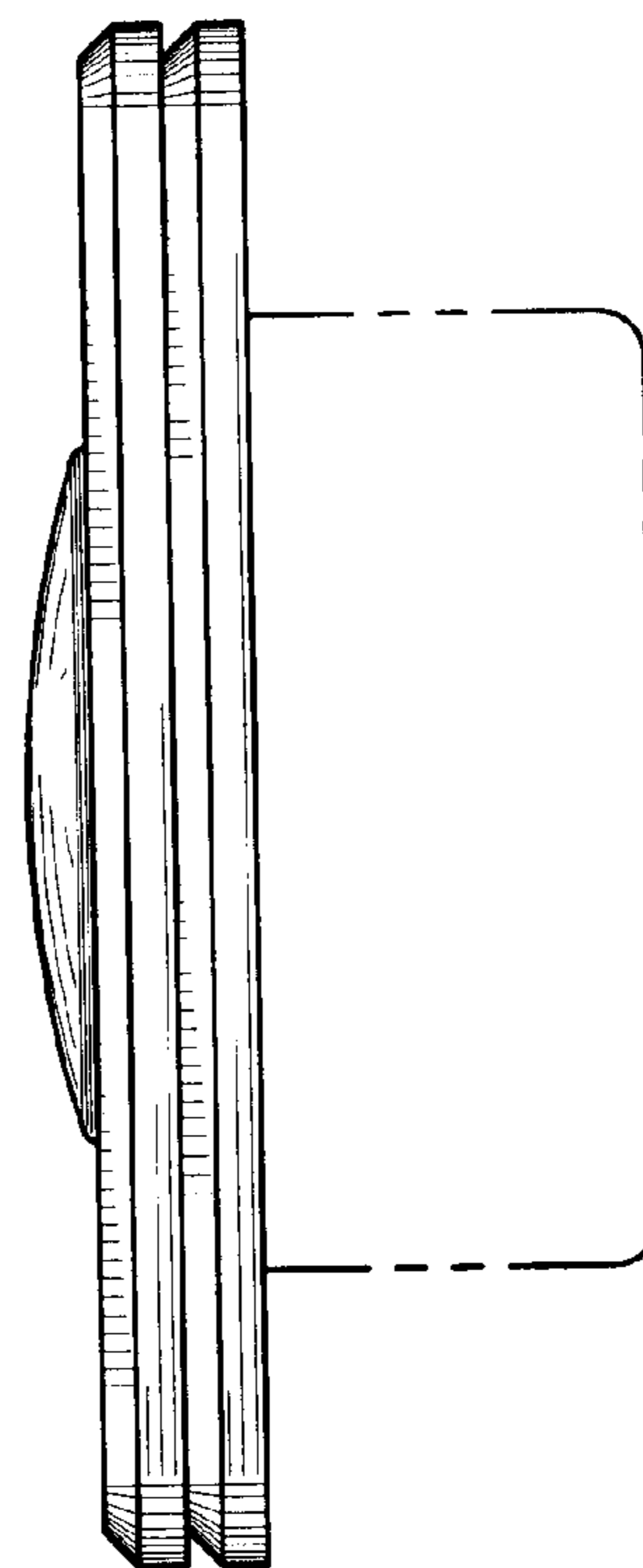

FIG. 4

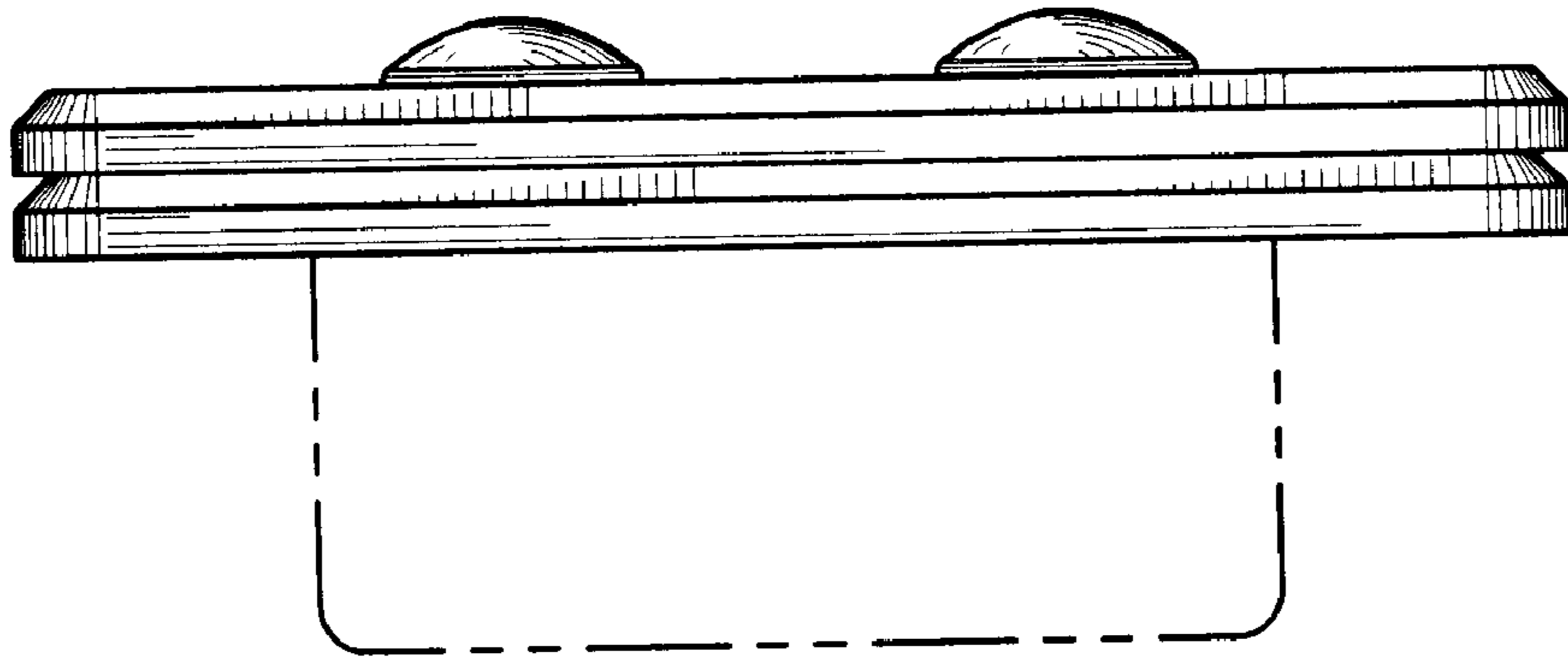

FIG. 5

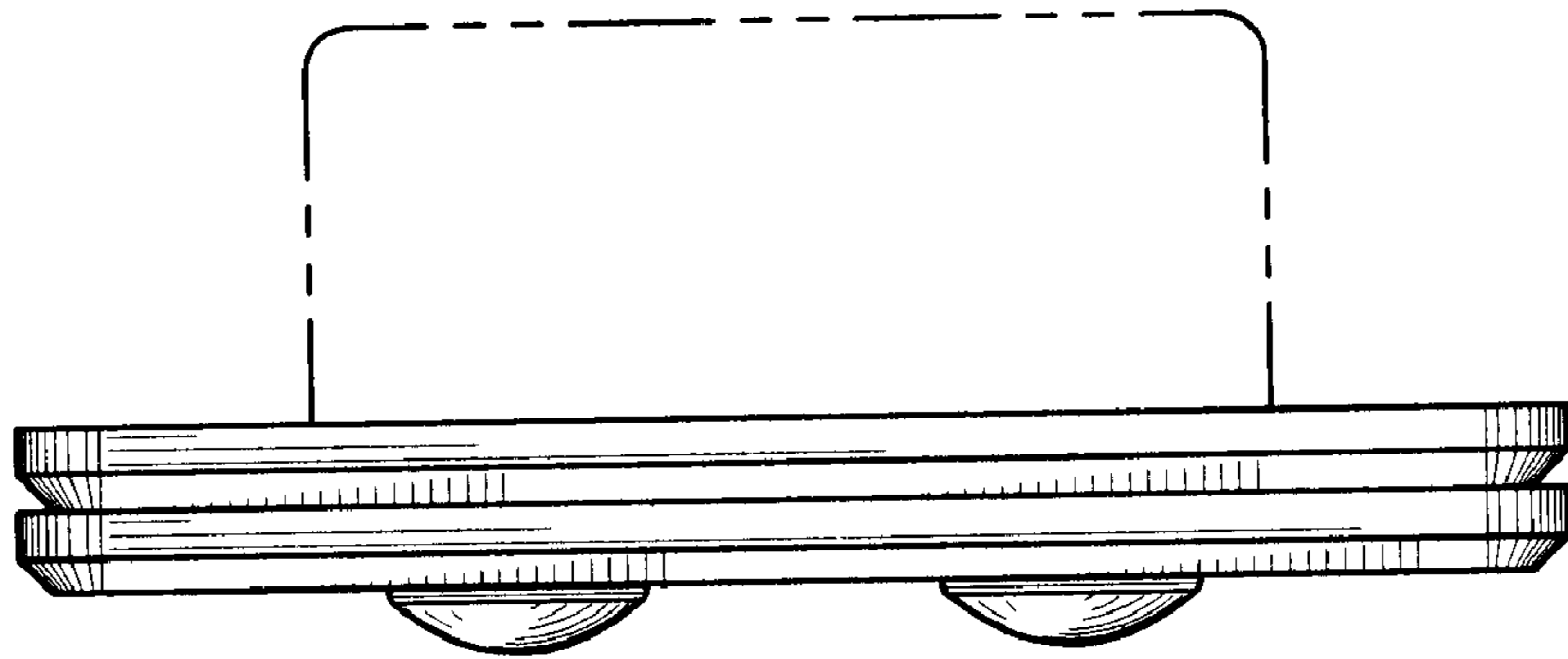

FIG. 6

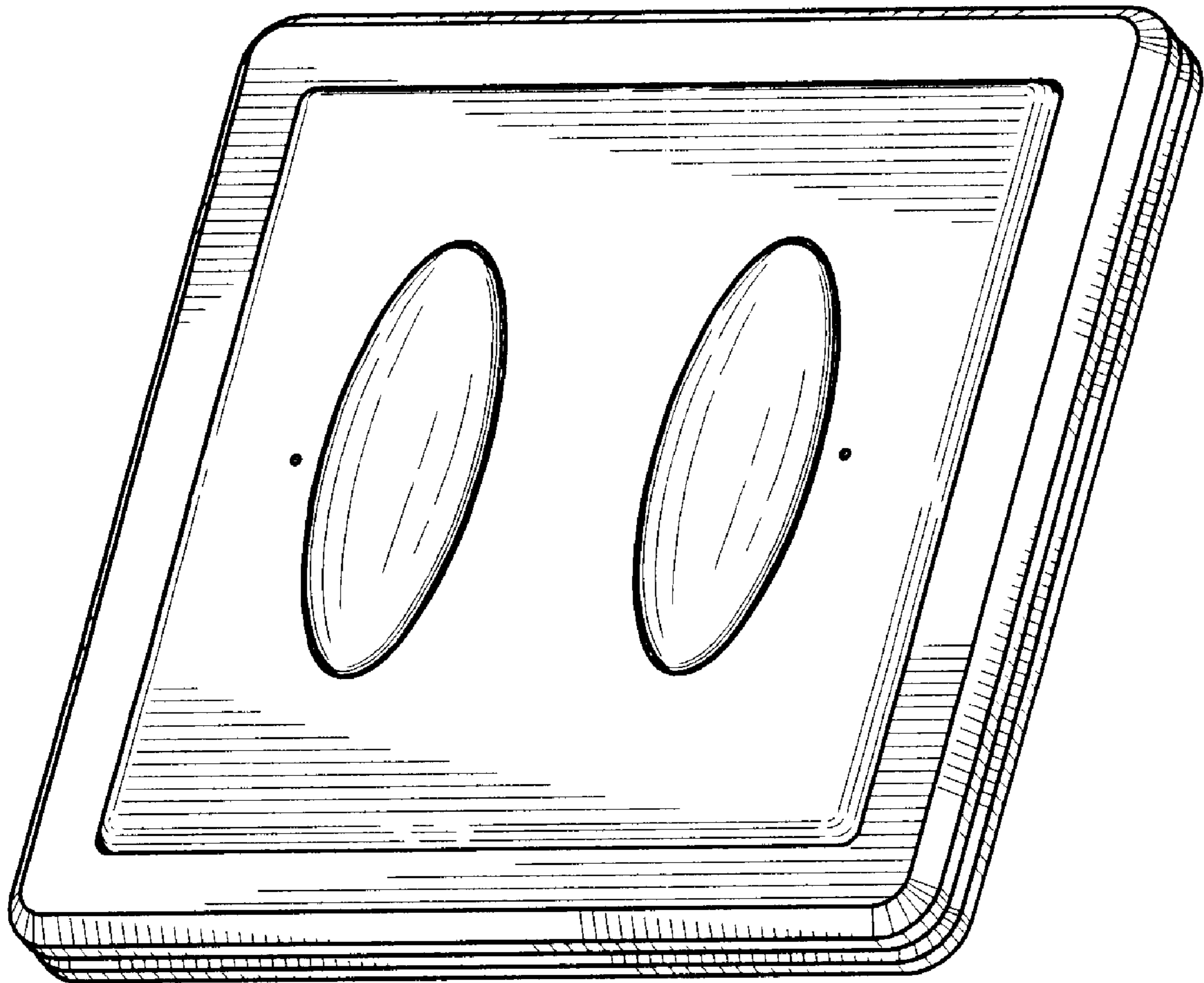

FIG. 7

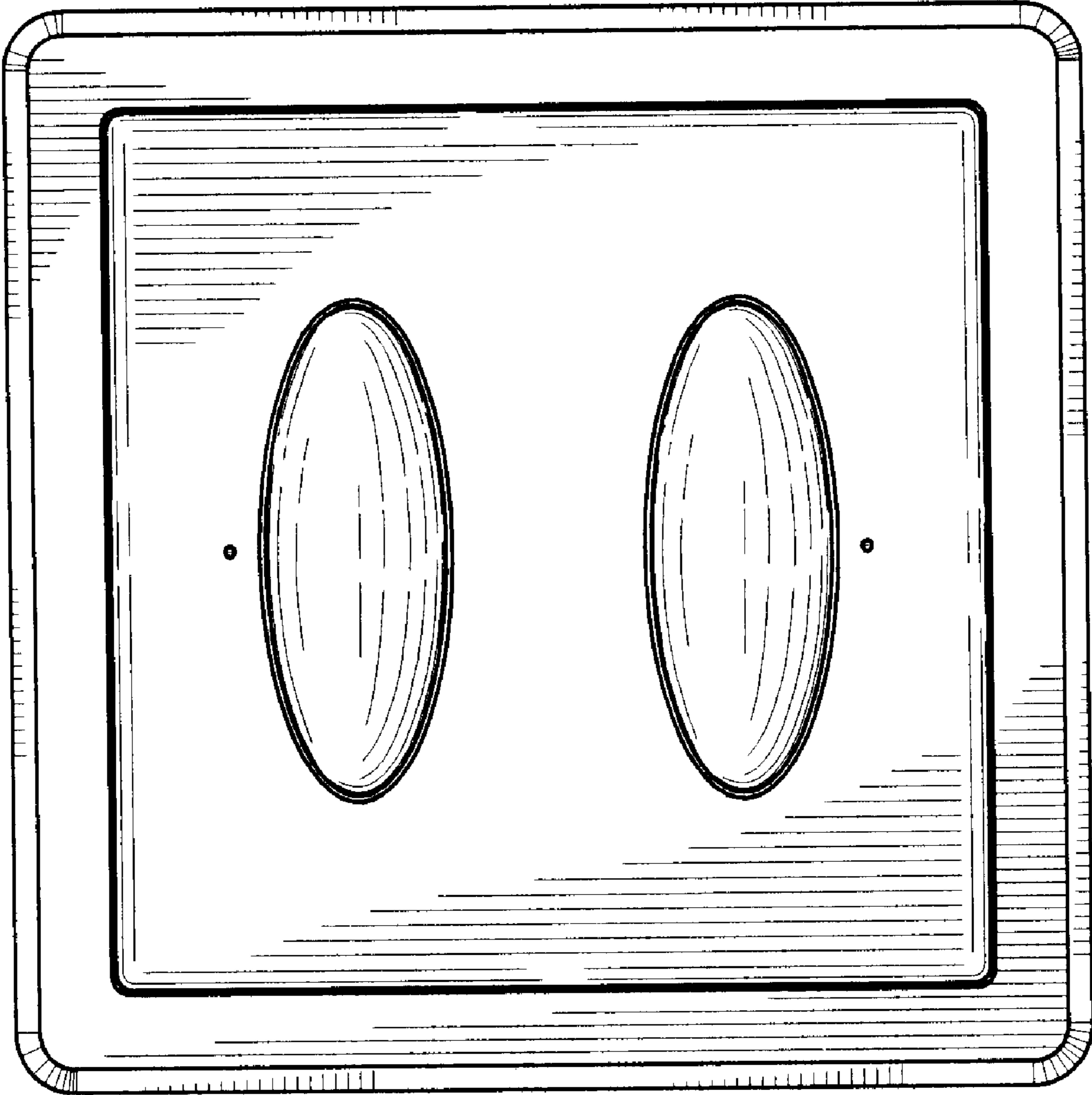

FIG. 8

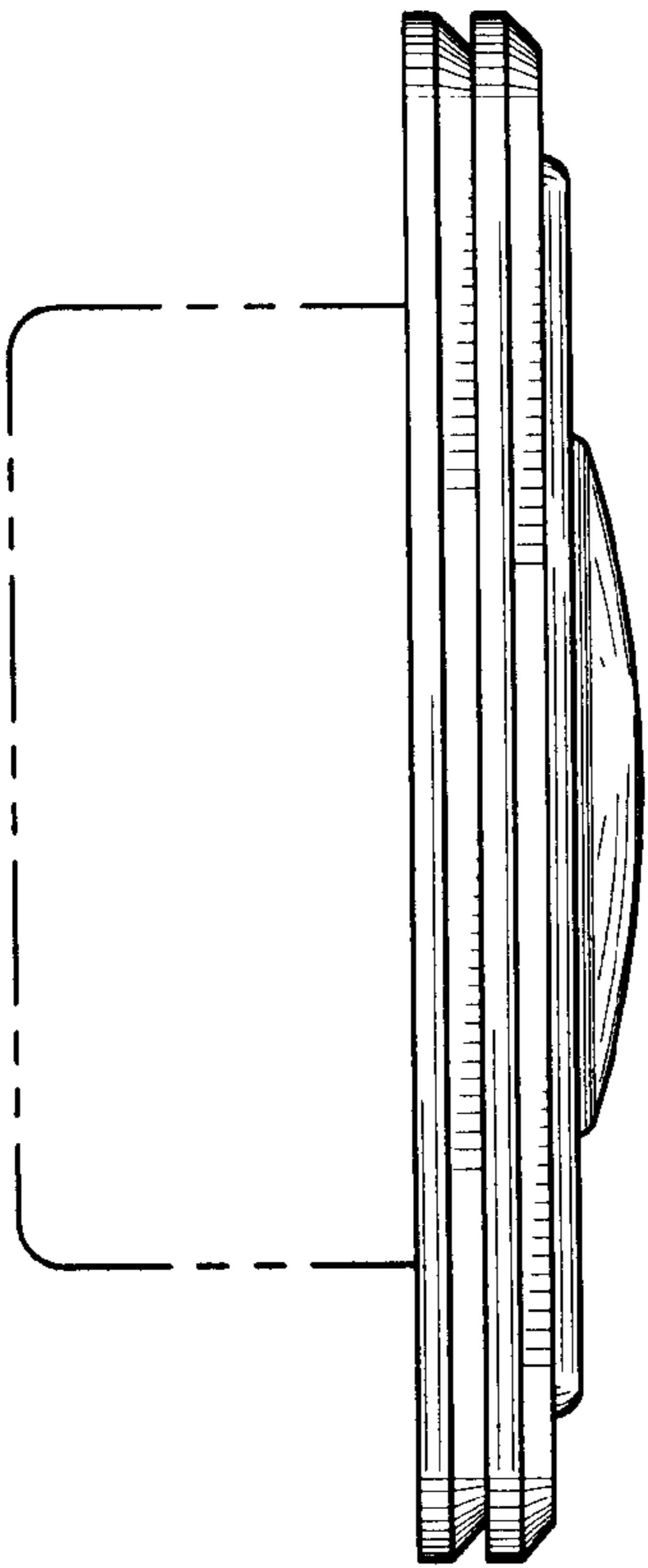

FIG. 9

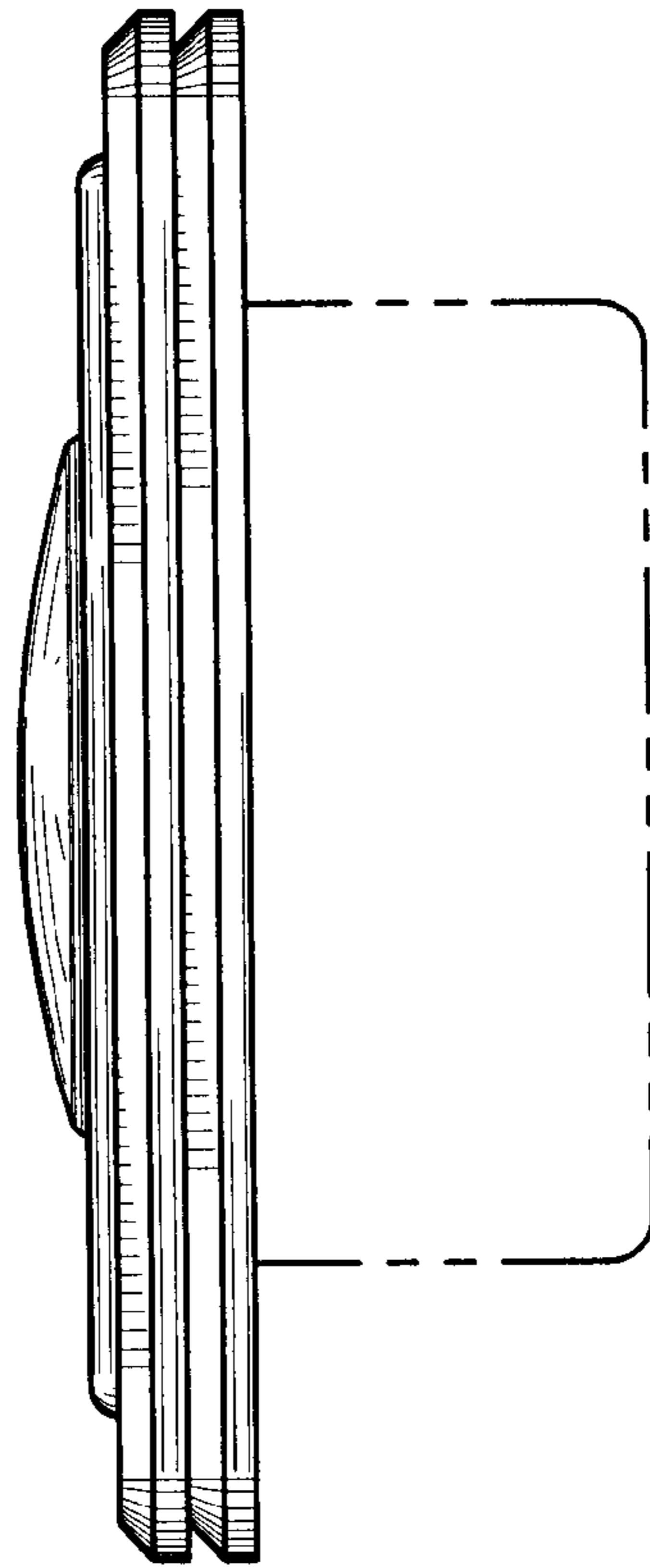

FIG. 10

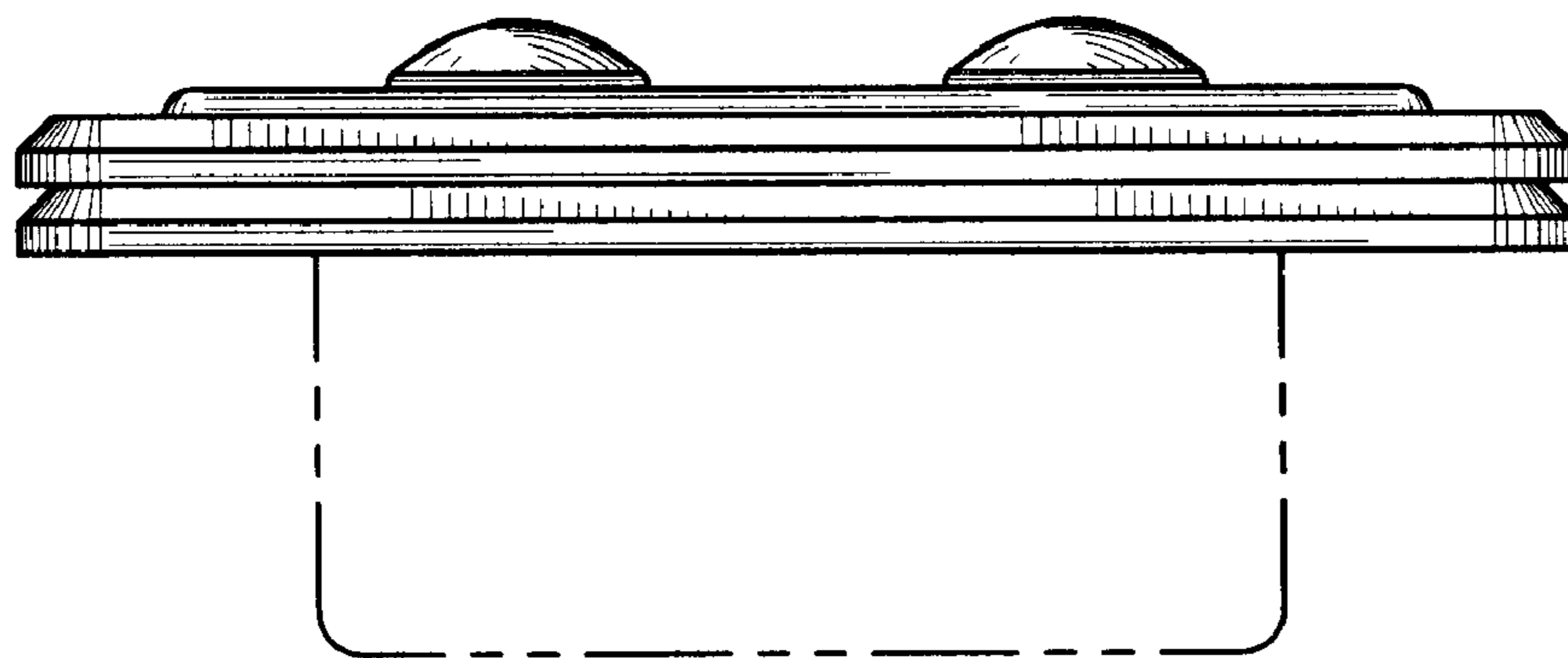

FIG. 11

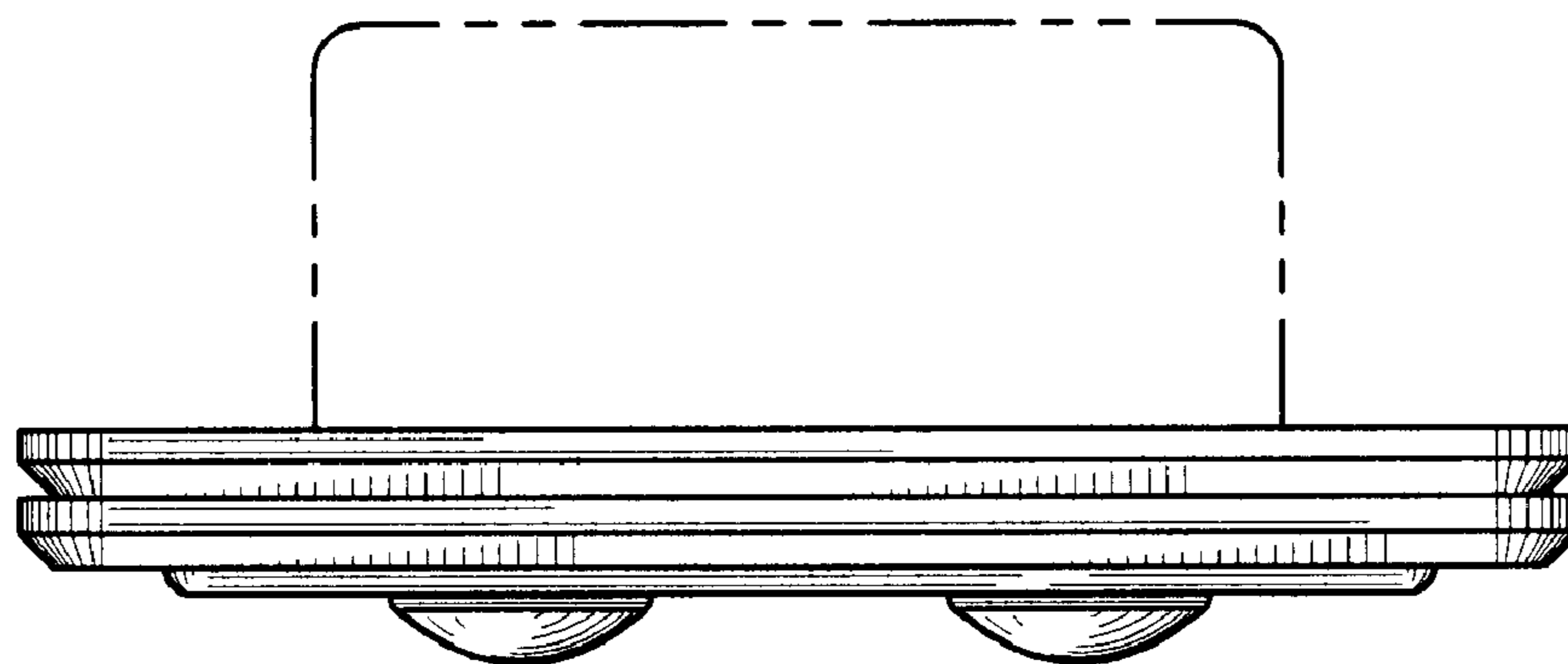

FIG. 12

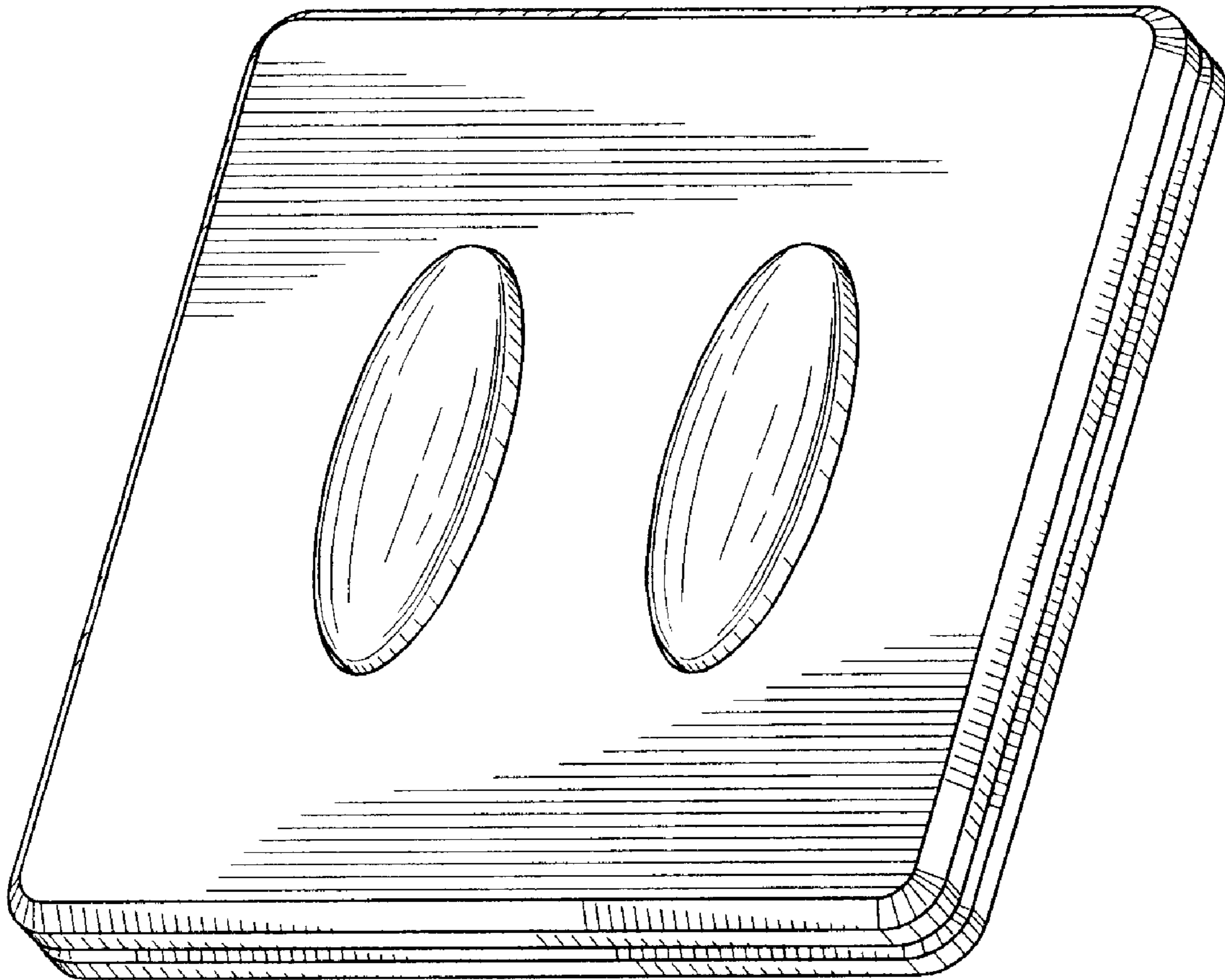

FIG. 13

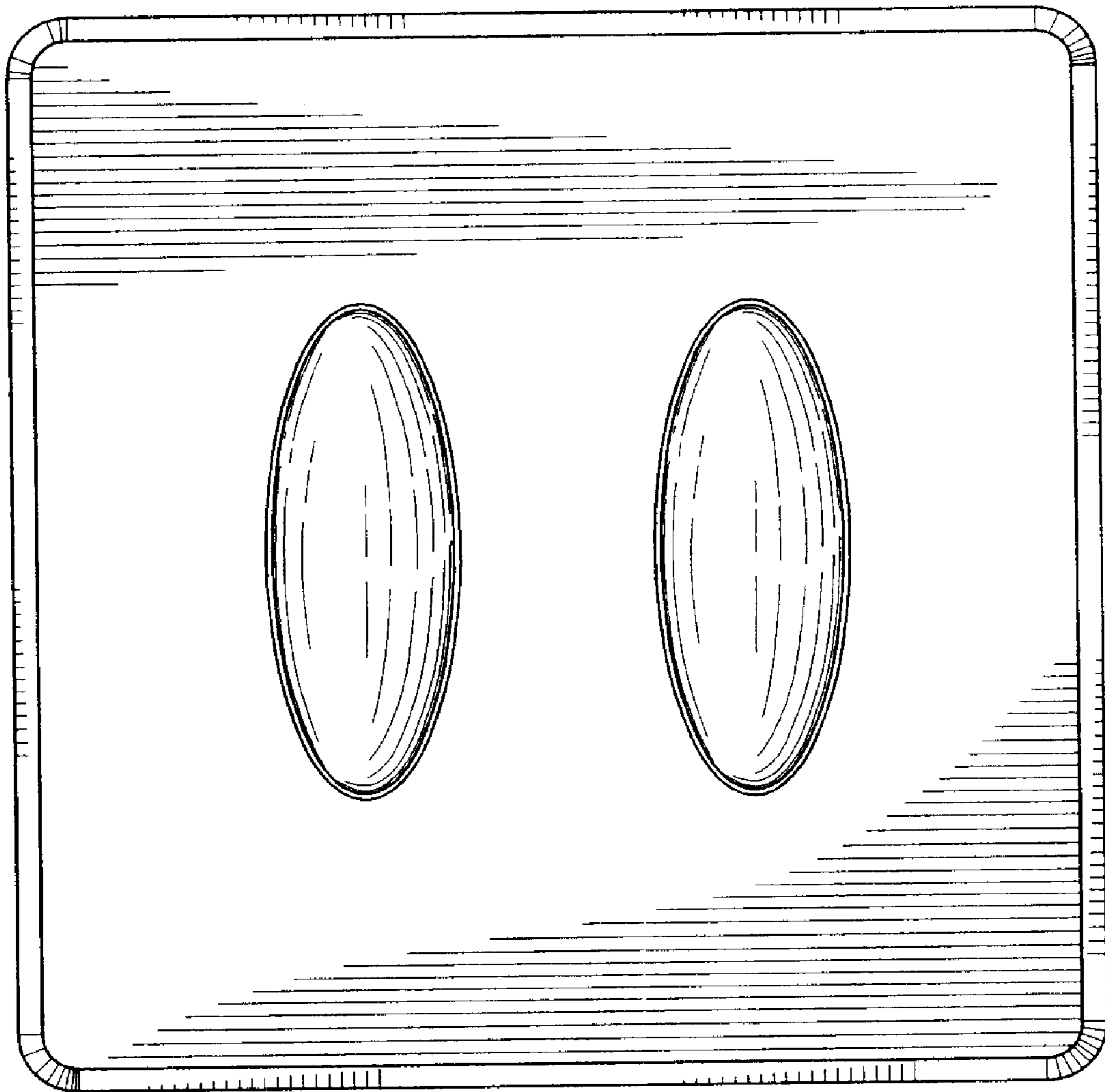

FIG. 14

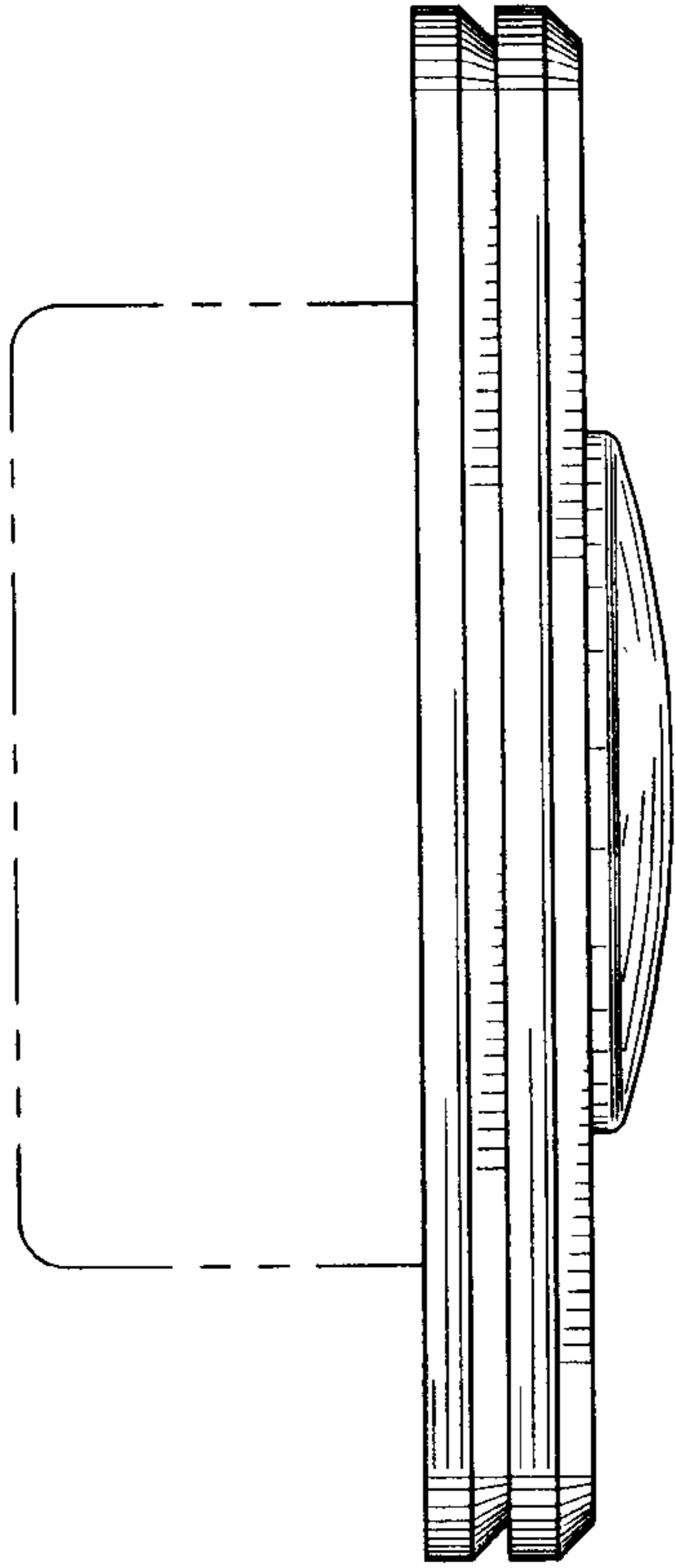

FIG. 15

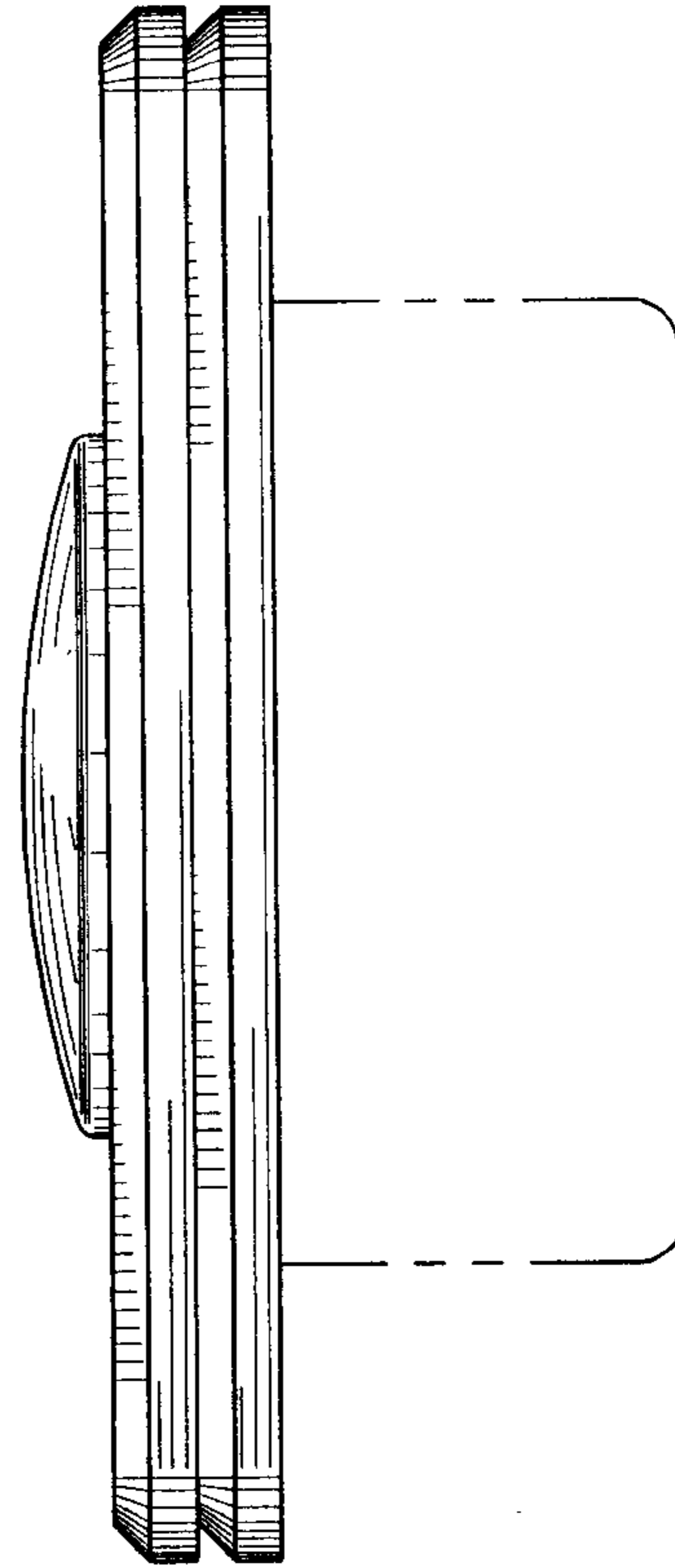

FIG. 16

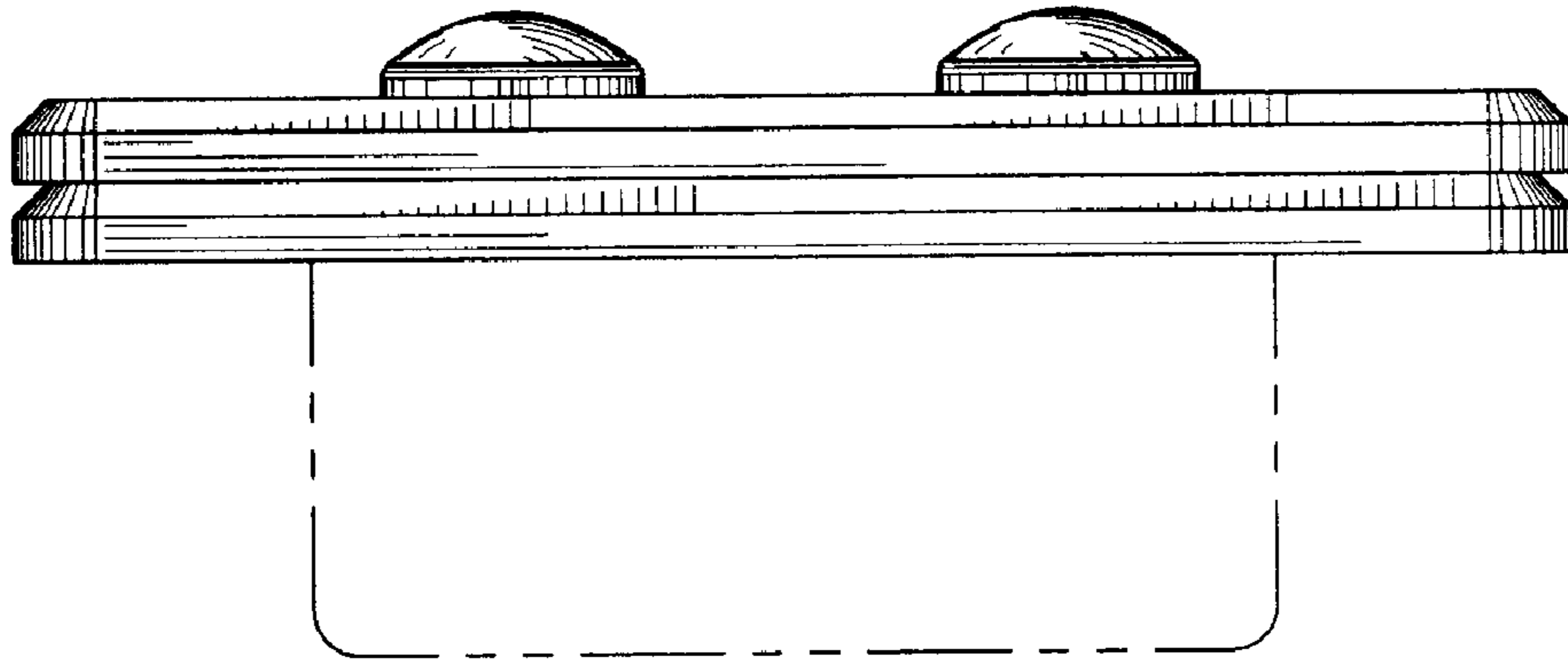

FIG. 17

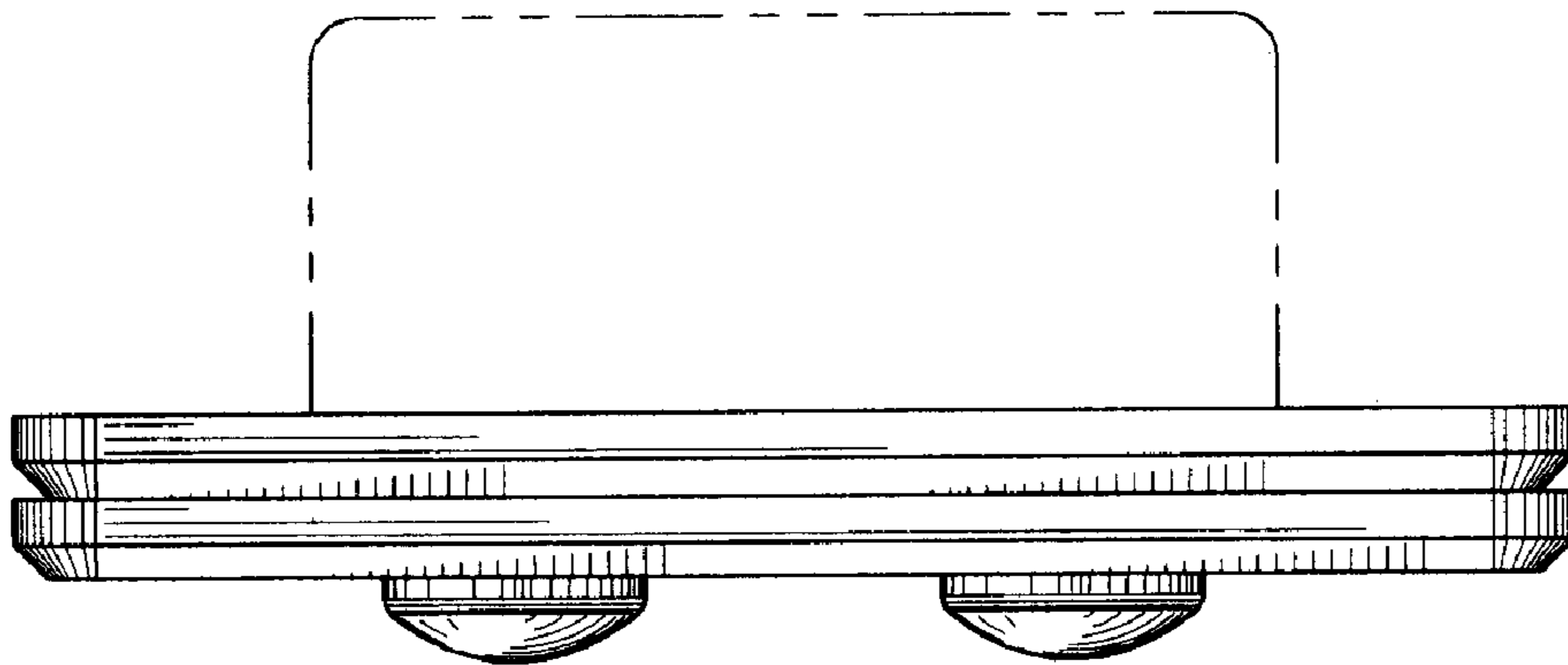

FIG. 18

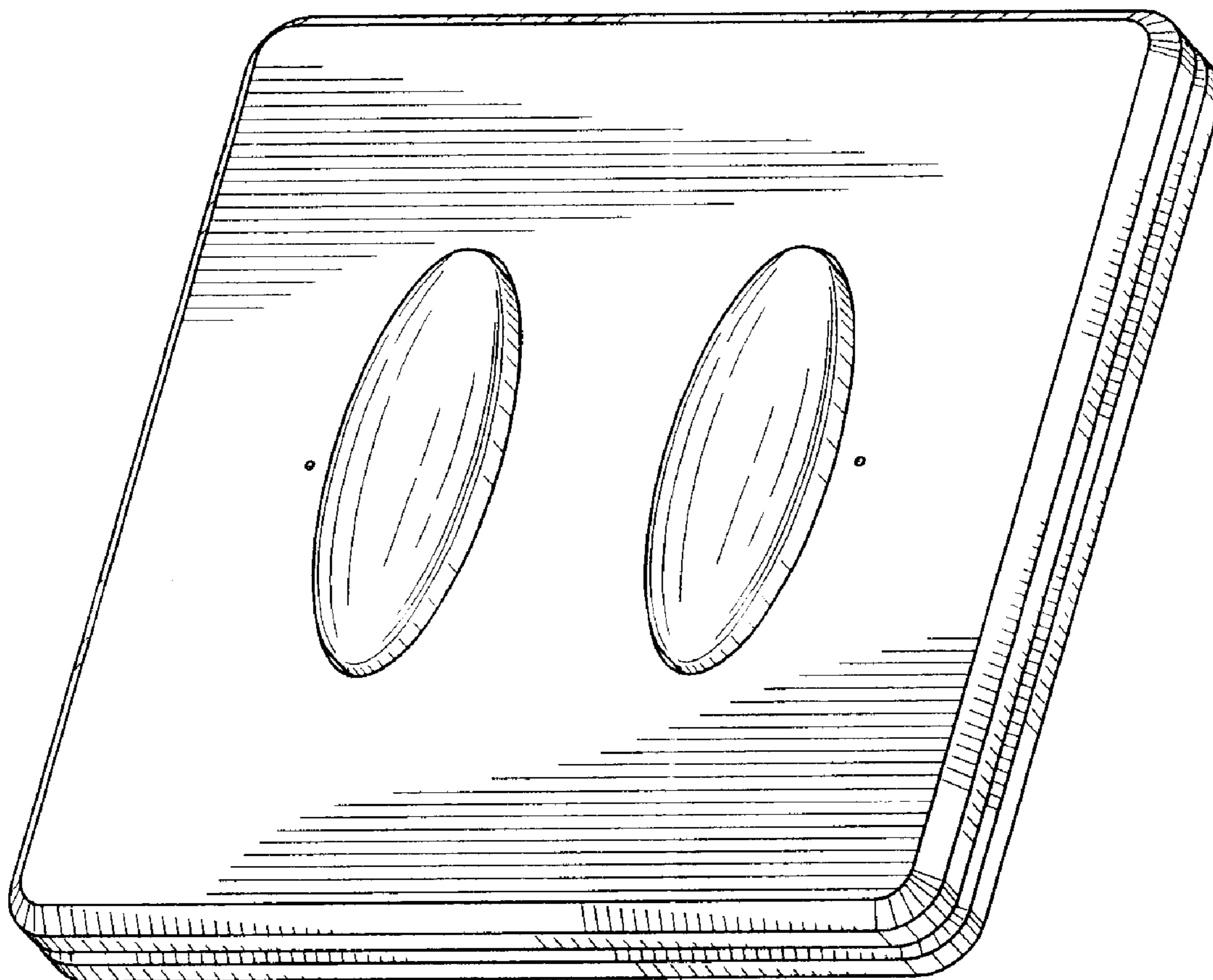

FIG. 19

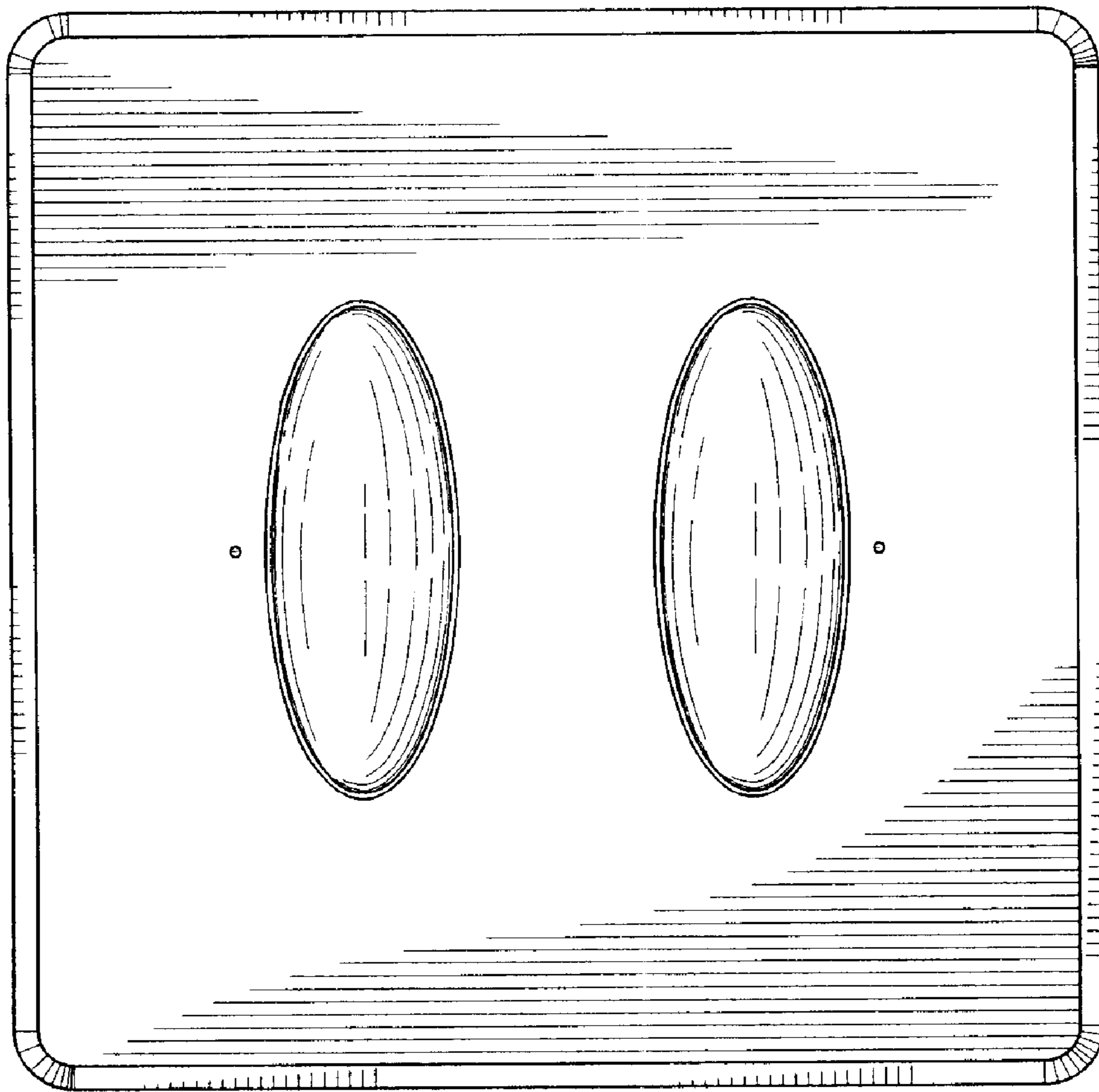

FIG. 20

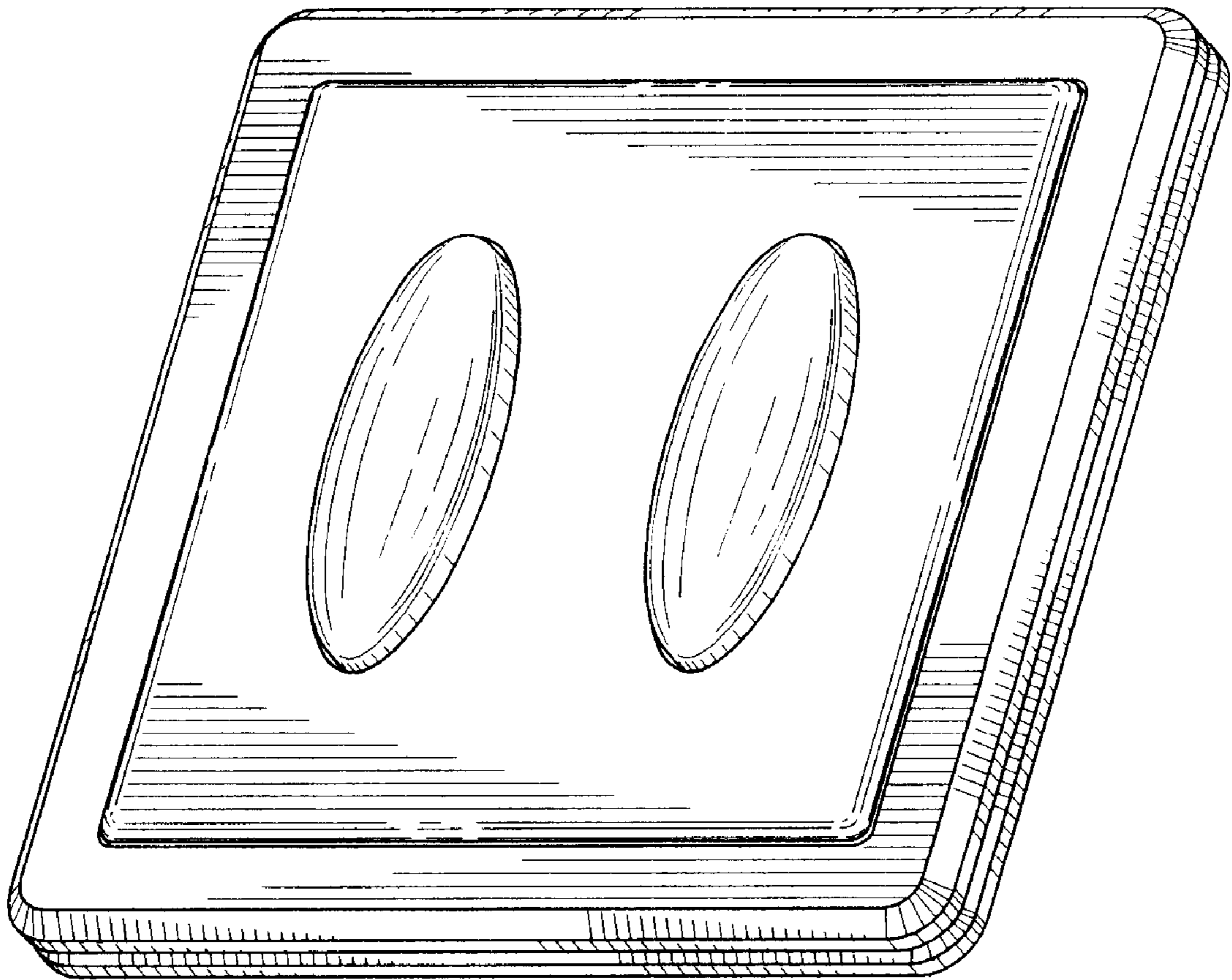

FIG. 21

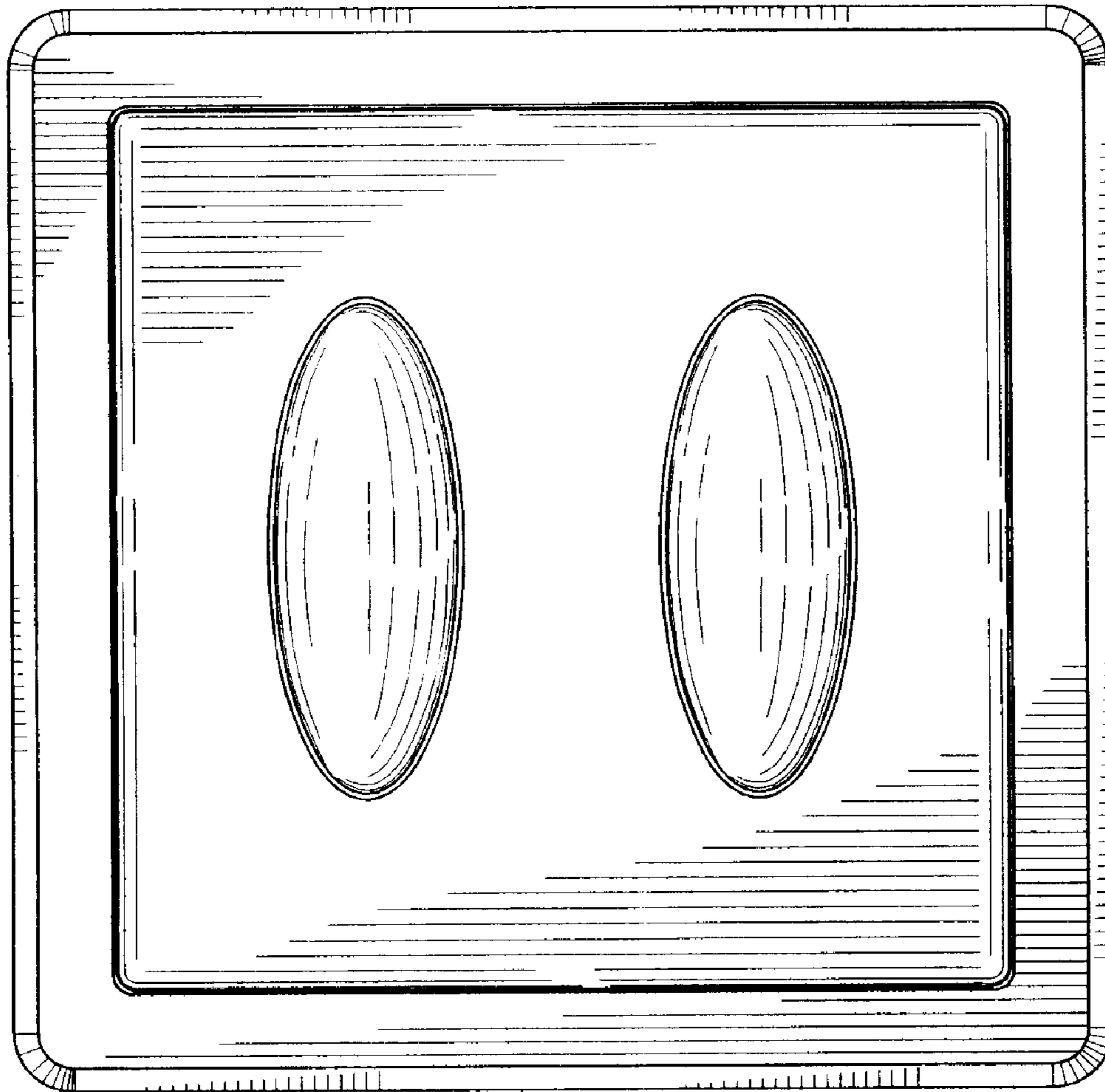

FIG. 22

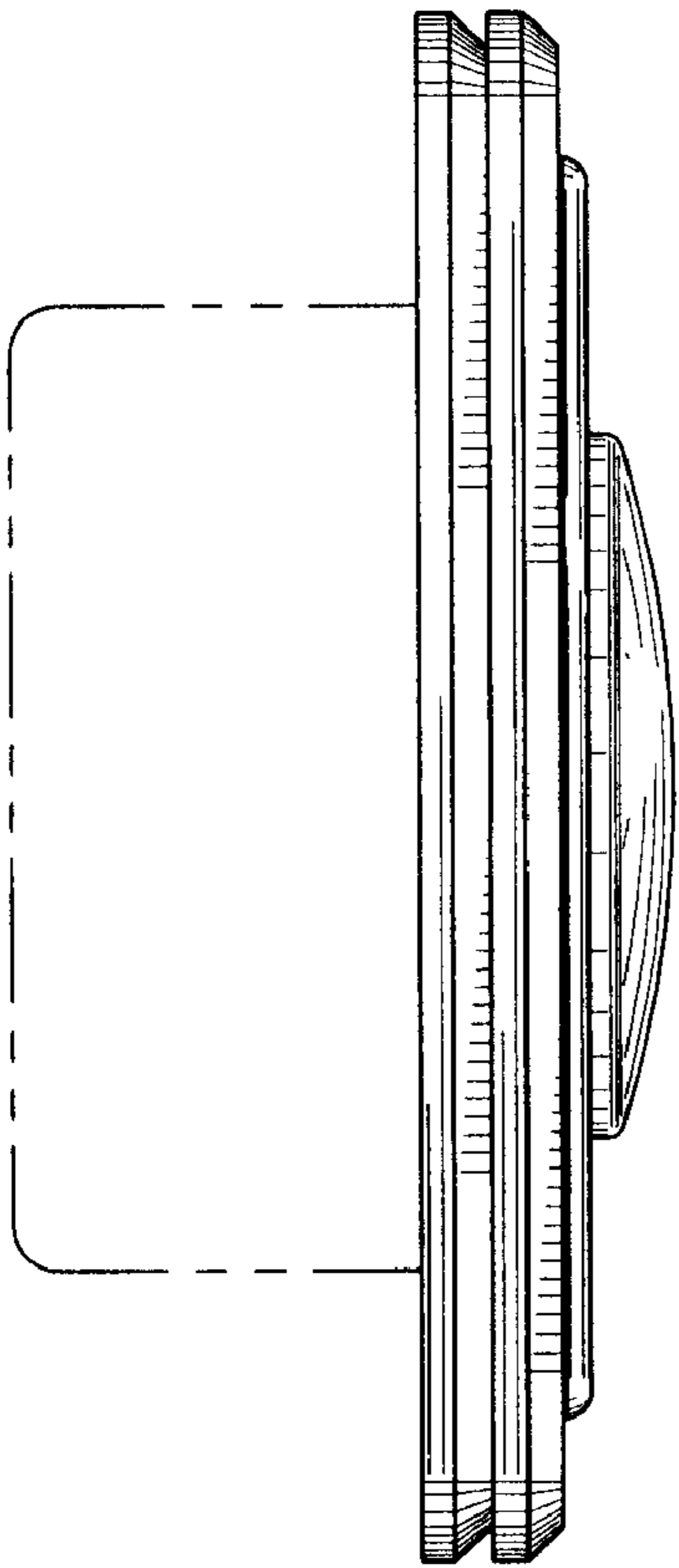

FIG. 23

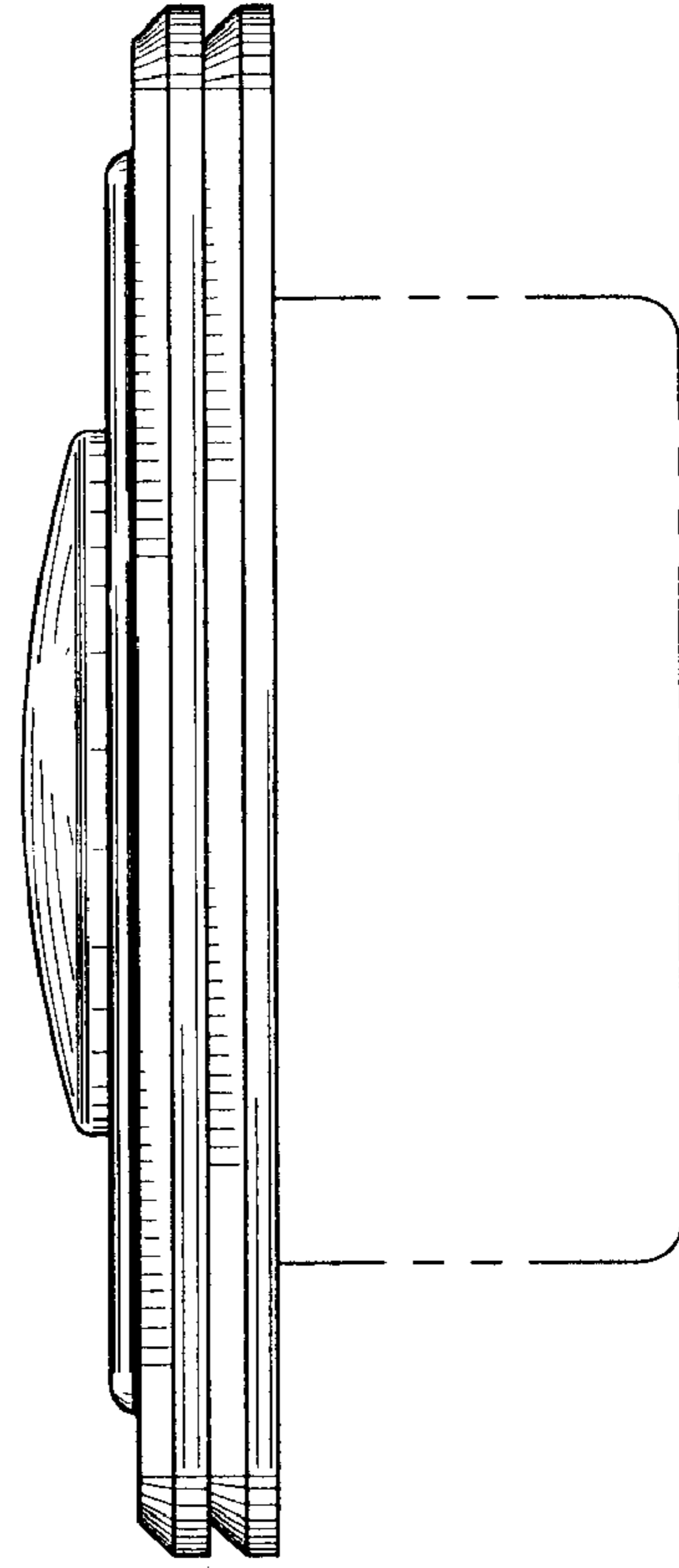

FIG. 24

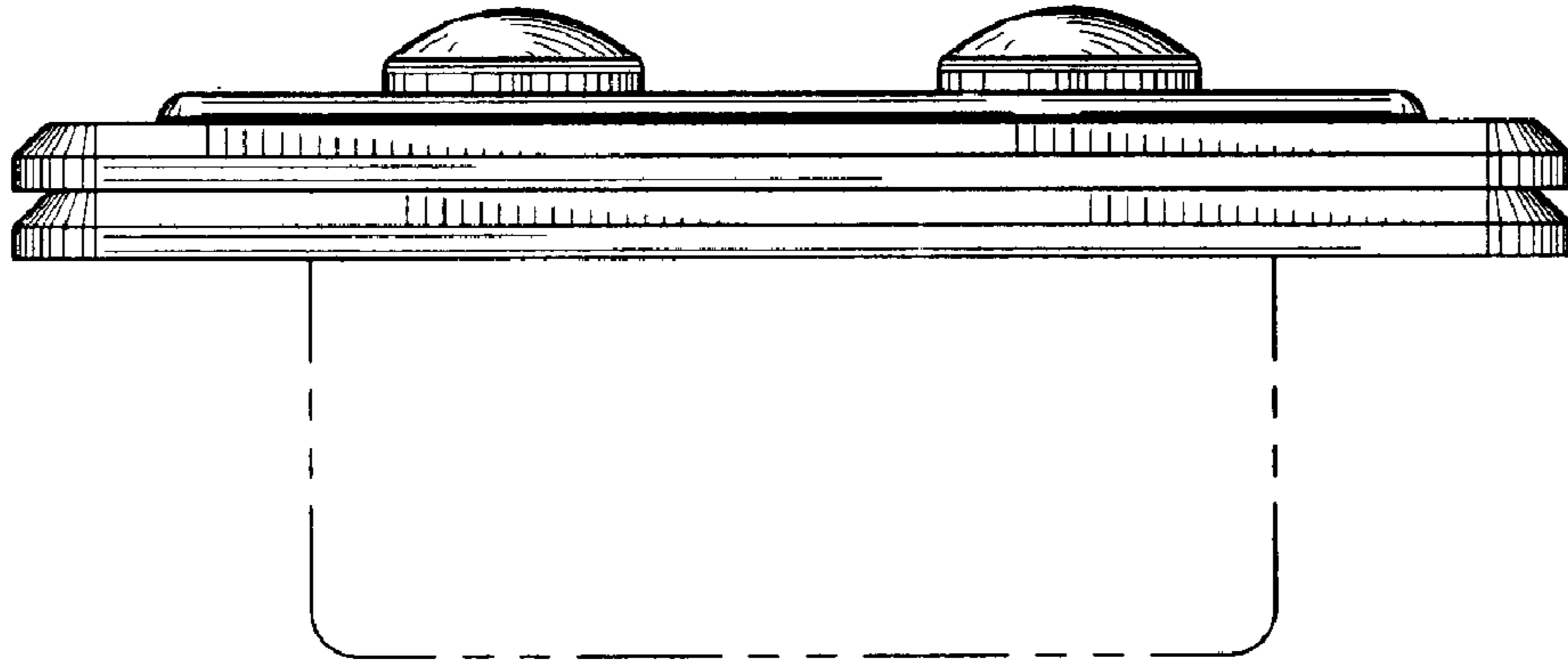

FIG. 25

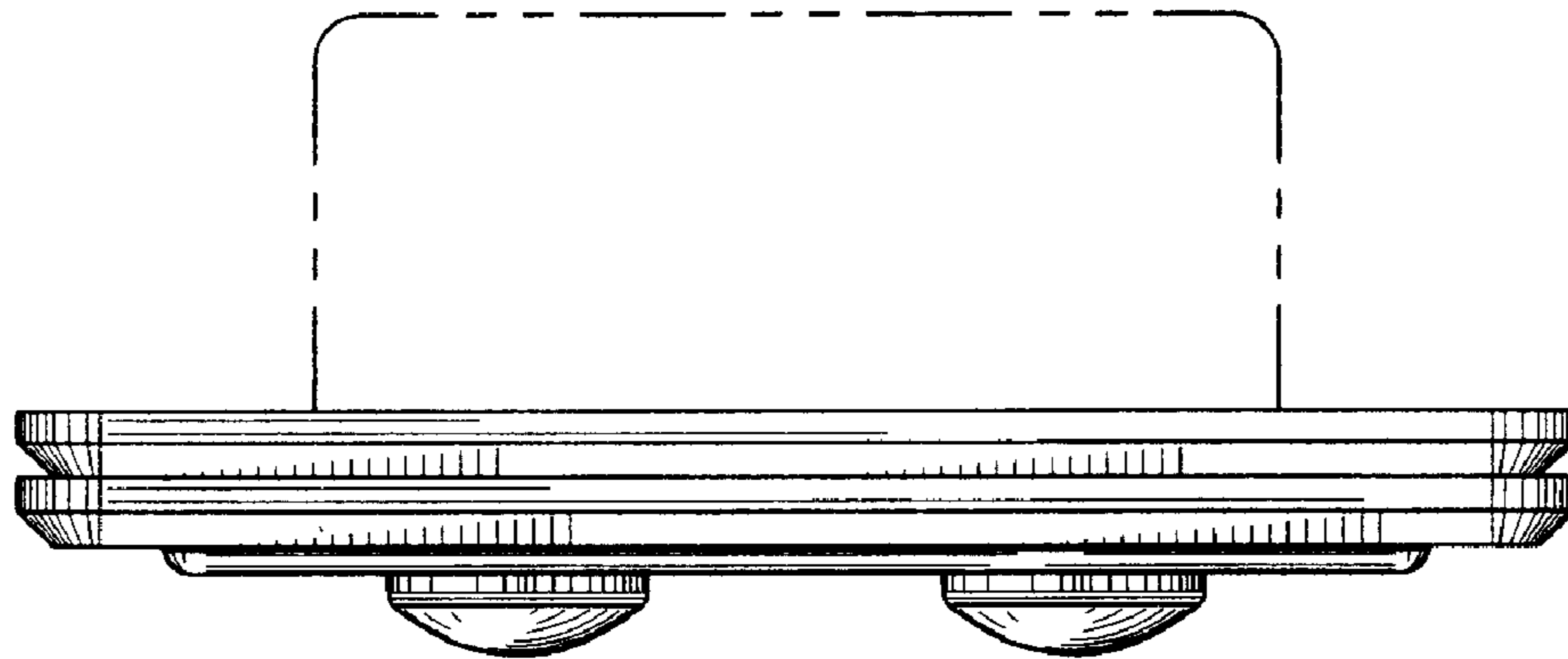

FIG. 26

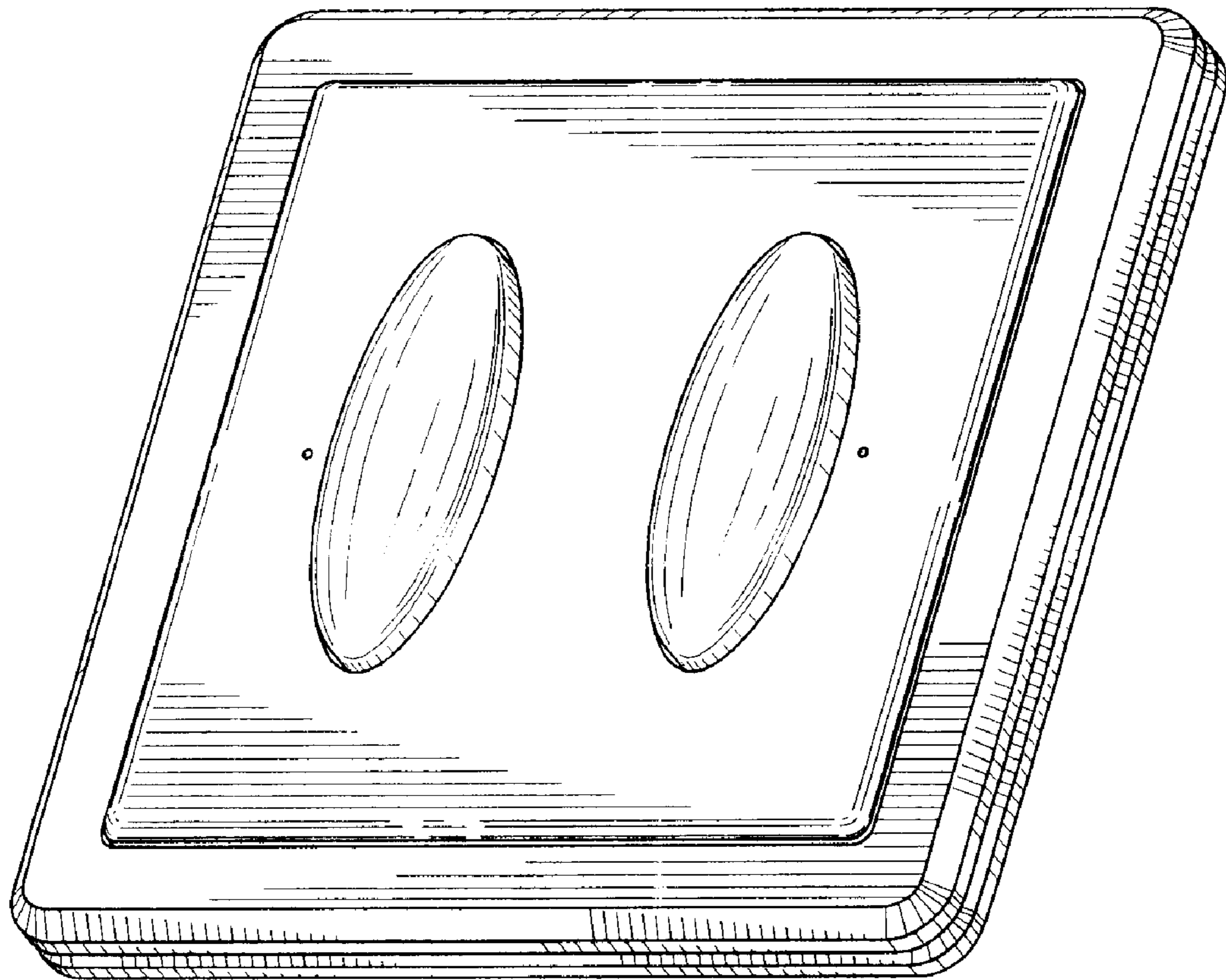

FIG. 27

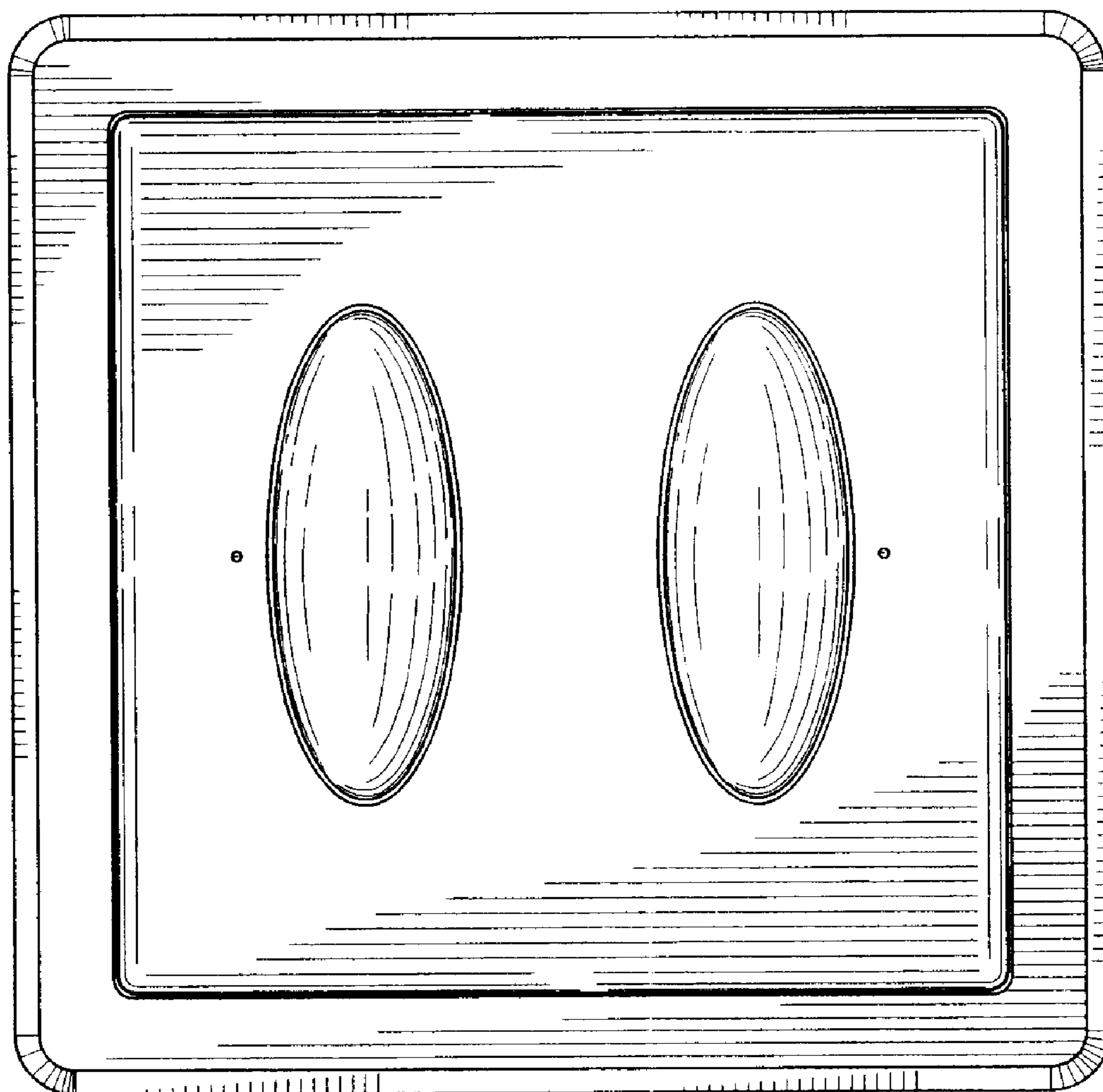

FIG. 28