



US00D540218S

(12) **United States Design Patent**
Sekiguchi

(10) **Patent No.: US D540,218 S**

(45) **Date of Patent: ** Apr. 10, 2007**

(54) **TRUCK CAB**

D425,826 S * 5/2000 Hellhake et al. D12/96
D443,576 S * 6/2001 Hayashi et al. D12/196

(75) Inventor: **Toru Sekiguchi**, Ageo (JP)

OTHER PUBLICATIONS

(73) Assignee: **Nissan Diesel Motor Co., Ltd.**,
Ageo-shi, Saitama-ken (JP)

A Pre-notification of Reasons for the Possible Rejection of the Pending Patent Examination of the corresponding Taiwanese patent application No. 93304544 and English translation.

(**) Term: **14 Years**

Two pages of 'Motor Magazine' published in Dec. 2000, No. 545.

(21) Appl. No.: **29/210,205**

* cited by examiner

(22) Filed: **Jul. 29, 2004**

(30) **Foreign Application Priority Data**

Feb. 2, 2004 (JP) 2004-002585

Primary Examiner—Melody N. Brown

(51) **LOC (8) Cl.** **12-16**

(74) *Attorney, Agent, or Firm*—Armstrong, Kratz, Quintos, Hanson & Brooks, LLP

(52) **U.S. Cl.** **D12/96**

(57) **CLAIM**

(58) **Field of Classification Search** D12/96,
D12/93; 296/190.1–190.3, 190.8; 180/89.12,
180/89.14, 89.16, 89.19

The ornamental design for a truck cab, as shown and described.

See application file for complete search history.

DESCRIPTION

(56) **References Cited**

FIG. 1 is a front, top and right perspective view of the truck cab of the present invention;

U.S. PATENT DOCUMENTS

FIG. 2 is a top plan view thereof;

D344,472 S * 2/1994 Savio D12/96

FIG. 3 is a front elevational view thereof;

D412,301 S * 7/1999 Dirks D12/96

FIG. 4 is a rear elevational view thereof;

D412,683 S * 8/1999 Sacco et al. D12/96

FIG. 5 is a right side elevational view thereof; and,

D416,829 S * 11/1999 Sacco et al. D12/96

FIG. 6 is a left side elevational view thereof.

D422,534 S * 4/2000 Hellhake et al. D12/96

1 Claim, 6 Drawing Sheets

D422,944 S * 4/2000 Hellhake et al. D12/96

D424,476 S * 5/2000 Hellhake et al. D12/96

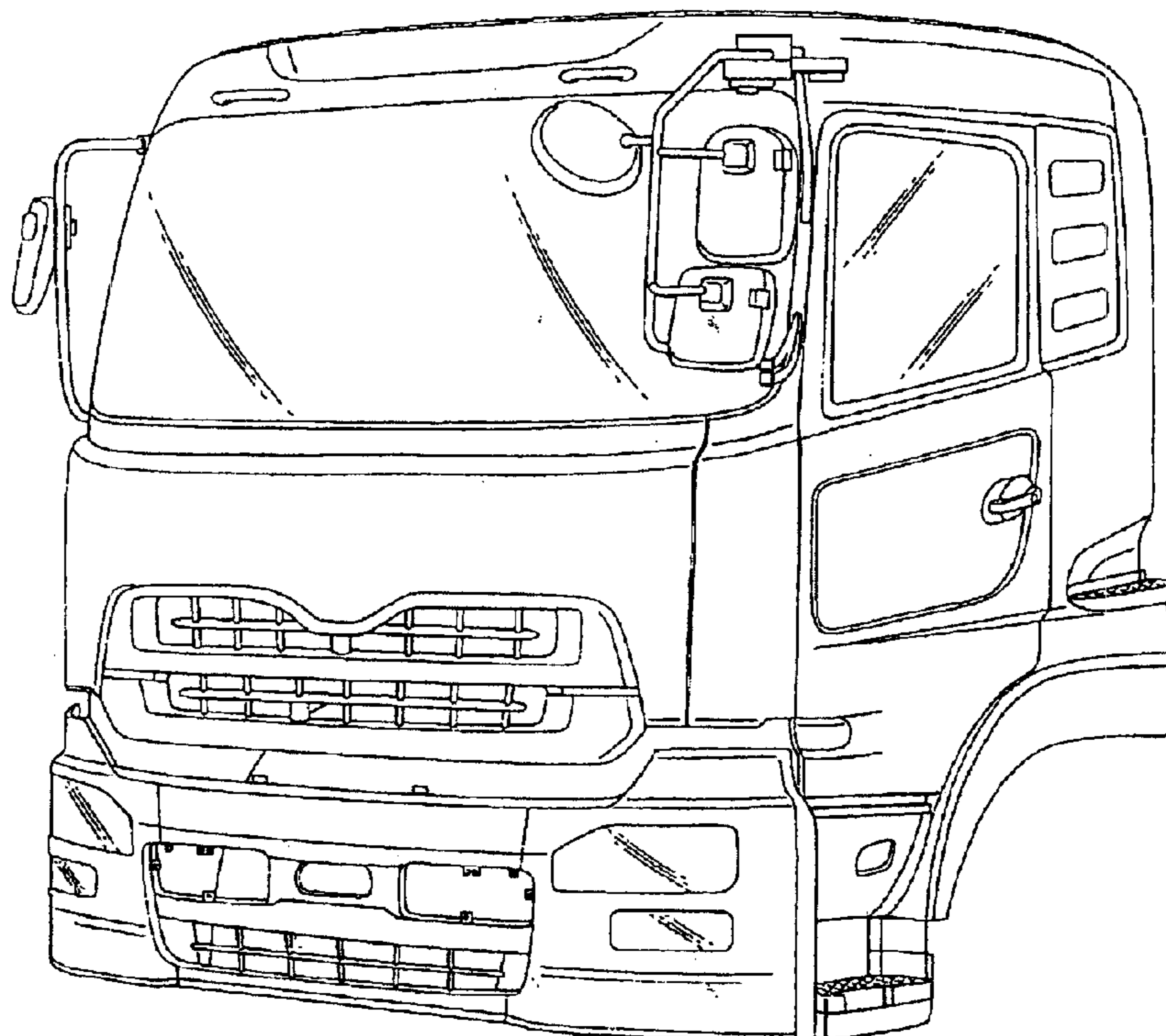

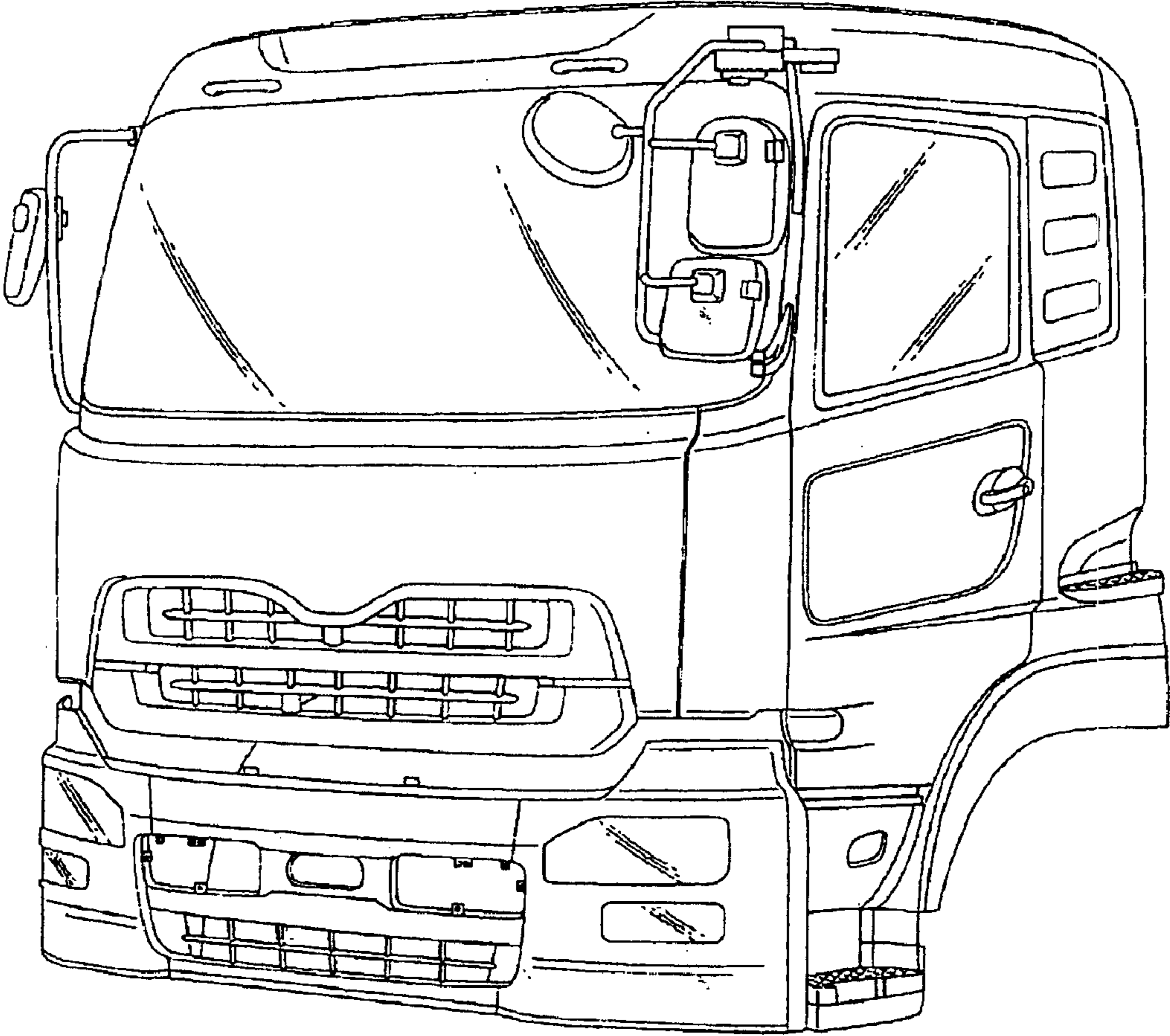

FIG. 1

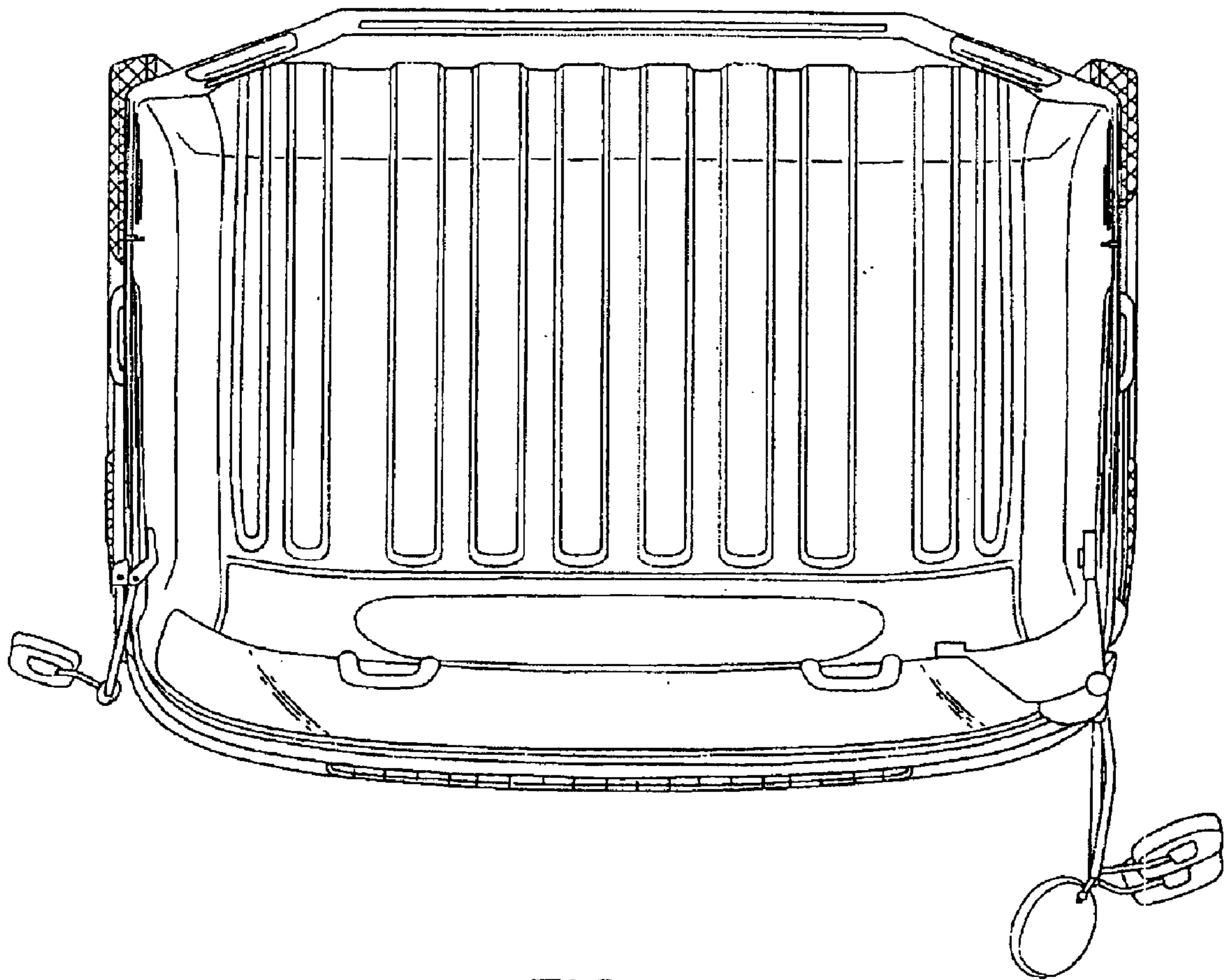

FIG. 2

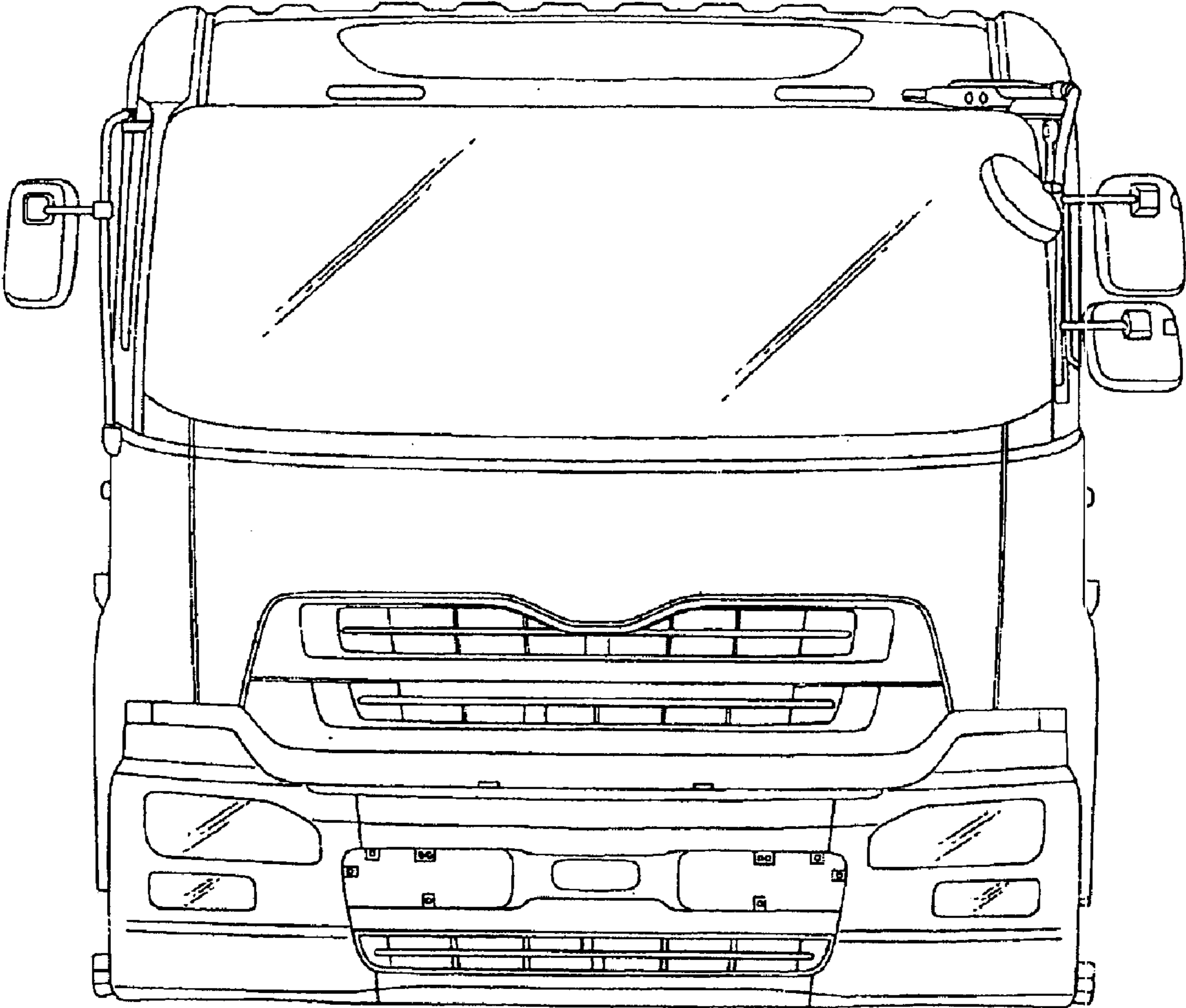

FIG. 3

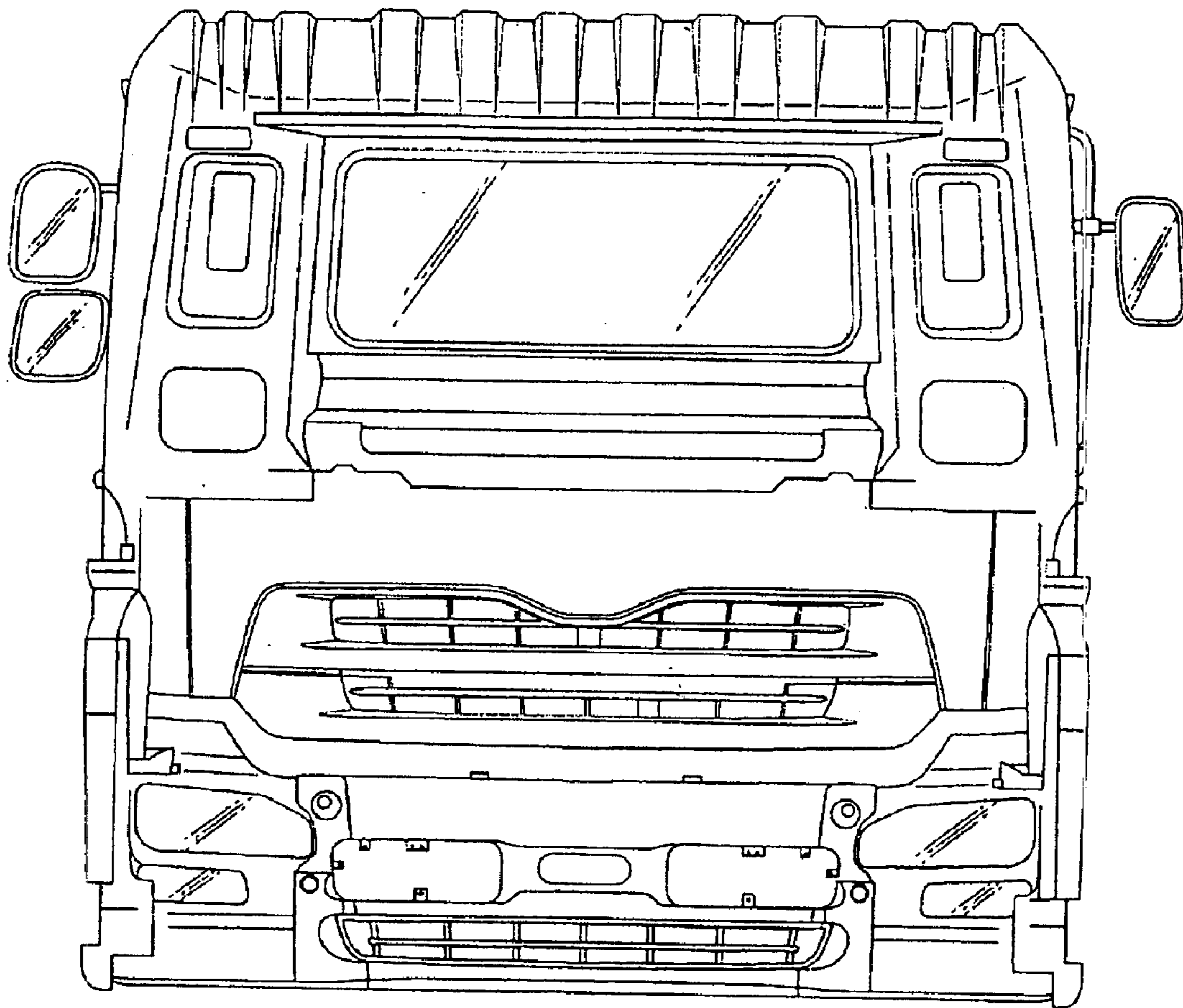

FIG. 4

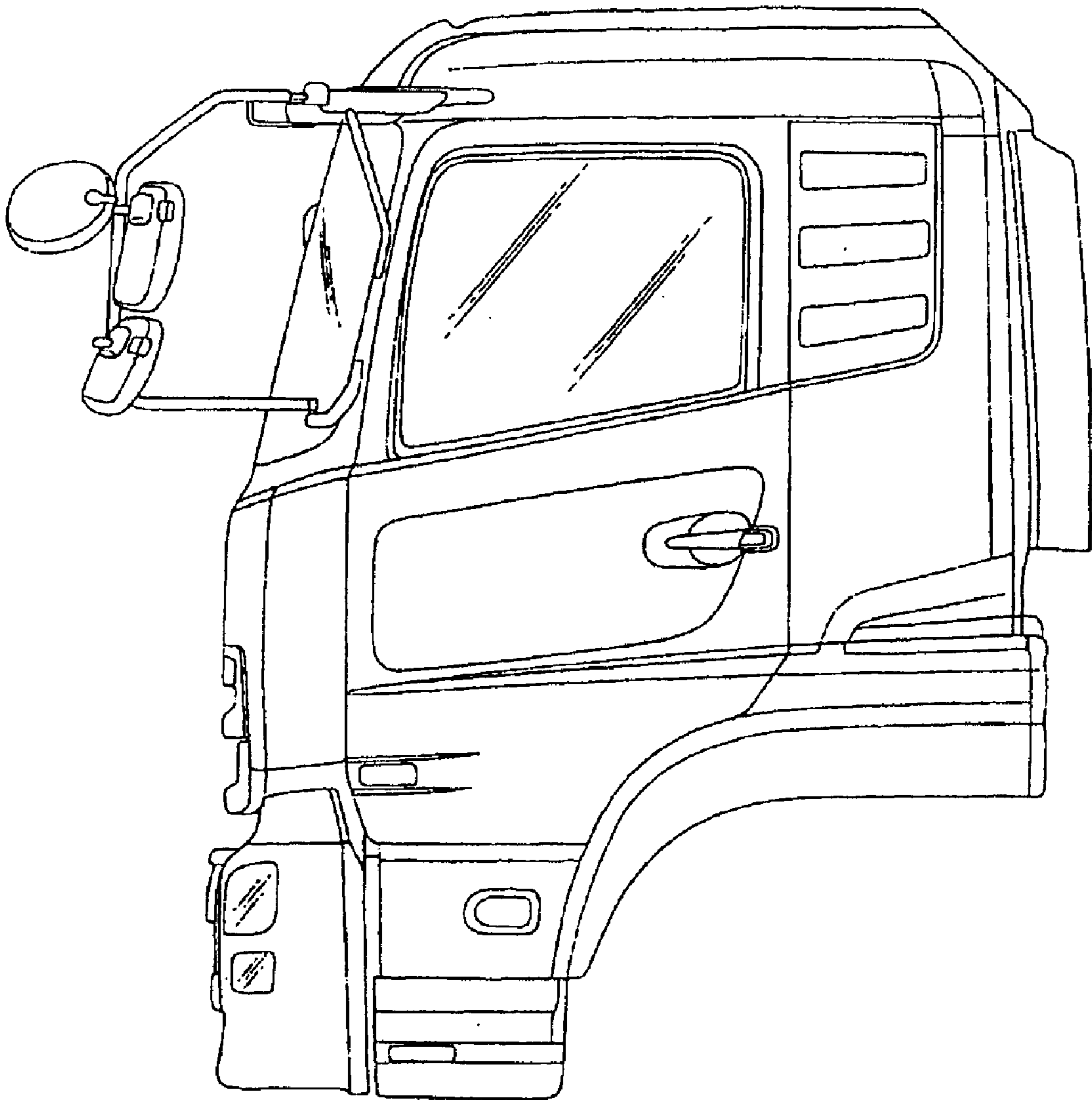

FIG. 5

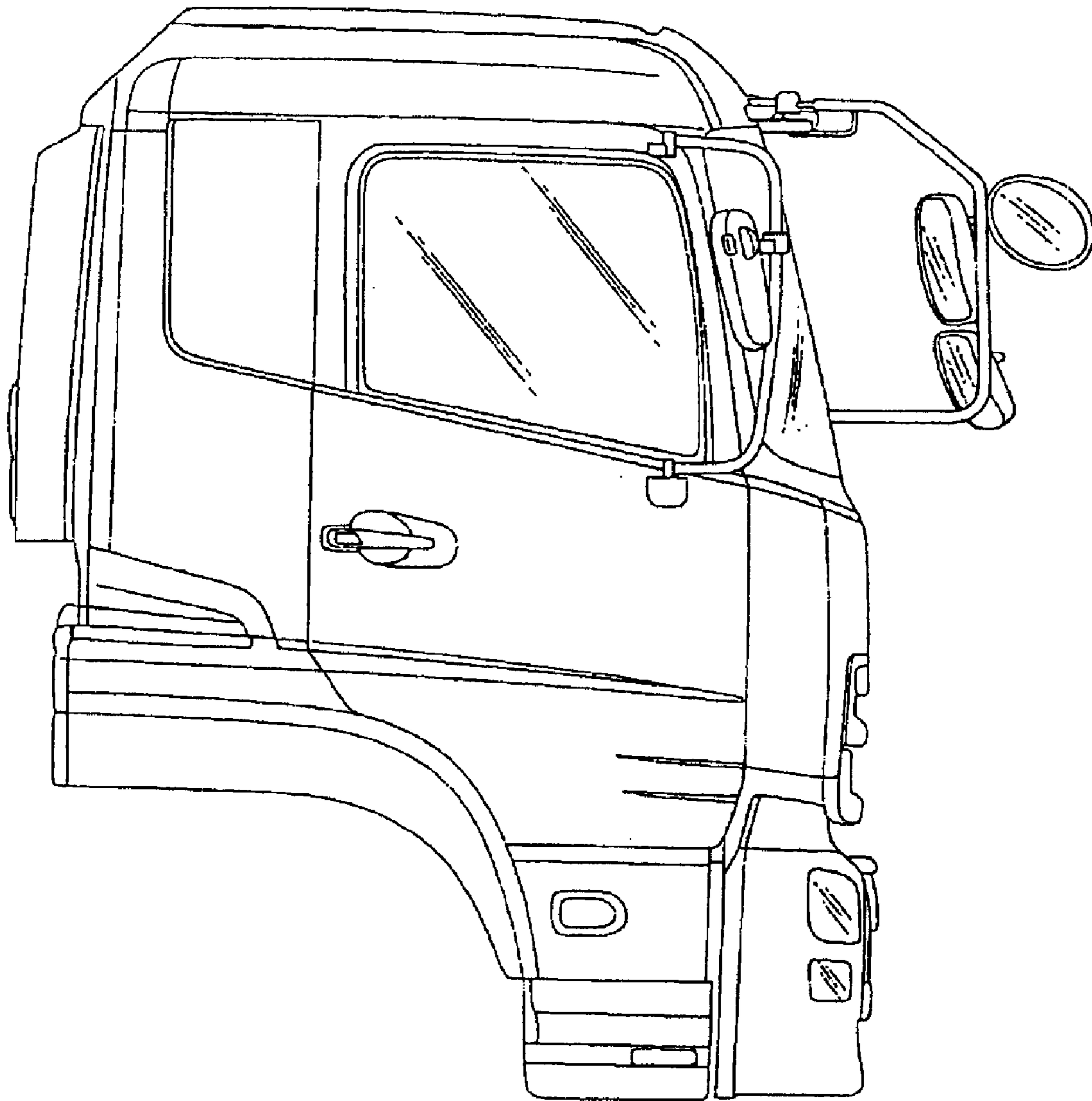

FIG. 6