

US00D540073S

(12) **United States Design Patent**
McDiarmid et al.

(10) **Patent No.:** **US D540,073 S**

(45) **Date of Patent:** **** Apr. 10, 2007**

(54) **SEAT AND BACKREST FOR A CHAIR**

(75) Inventors: **Ronald D. McDiarmid**, La Habra, CA (US); **Jose Enriquez Ortiz**, Lewisville, TX (US)

(73) Assignee: **Gruga, U.S.A.**, Irwindale, CA (US)

(**) Term: **14 Years**

(21) Appl. No.: **29/255,112**

(22) Filed: **Mar. 3, 2006**

(51) **LOC (8) Cl.** **06-01**

(52) **U.S. Cl.** **D6/500; D6/366**

(58) **Field of Classification Search** D6/334-335, D6/356, 364, 365, 366, 367, 368, 374, 500-502; 297/452.21, 452.26, 452.29, 452.32, 452.35, 297/452.37, 452.48

See application file for complete search history.

(56) **References Cited**

U.S. PATENT DOCUMENTS

D415,373 S	*	10/1999	Zaidman	D6/500
D481,231 S	*	10/2003	True	D6/500
D491,398 S	*	6/2004	True	D6/500
D494,391 S	*	8/2004	True	D6/366

D494,788 S	*	8/2004	True	D6/500
D511,260 S	*	11/2005	True	D6/500
D518,319 S	*	4/2006	True	D6/500

* cited by examiner

Primary Examiner—Mimosa De

(74) *Attorney, Agent, or Firm*—Sheppard, Mullin, Richter & Hampton LLP

(57) **CLAIM**

We claim the ornamental design of a seat and backrest for a chair, as shown and described.

DESCRIPTION

FIG. 1 is a left, front perspective view of a seat and backrest for a chair embodying our new design.

FIG. 2 is a front elevational view thereof.

FIG. 3 is a rear elevational view thereof.

FIG. 4 is a right side elevational view thereof, the left side elevational view being a mirror image thereof.

FIG. 5 is a top plan elevational view thereof; and,

FIG. 6 is a bottom plan elevational view thereof.

The broken lines shown on the seat and backrest are intended to represent stitching. The broken lines depicting chair arms and a chair base are not part of the design.

1 Claim, 5 Drawing Sheets

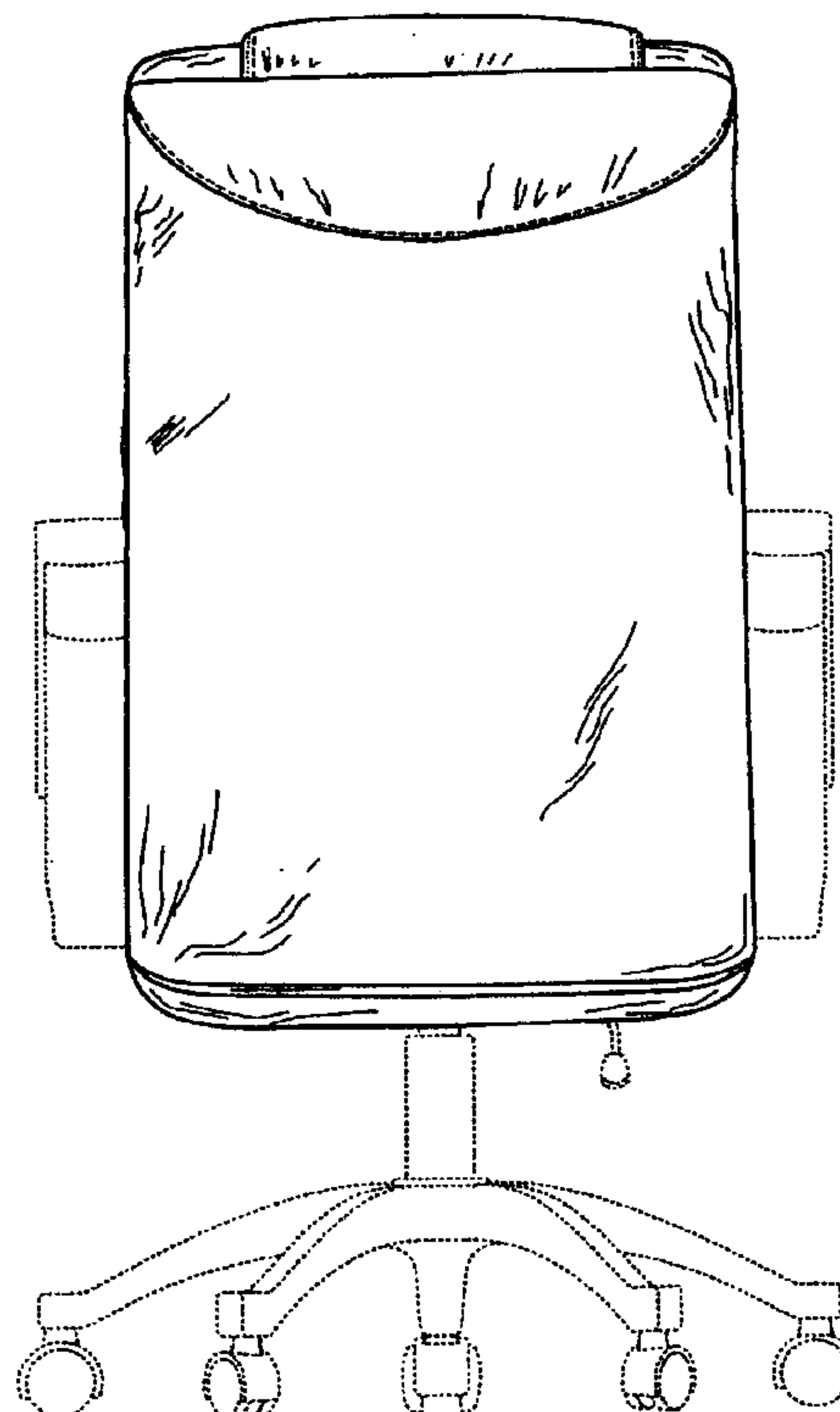
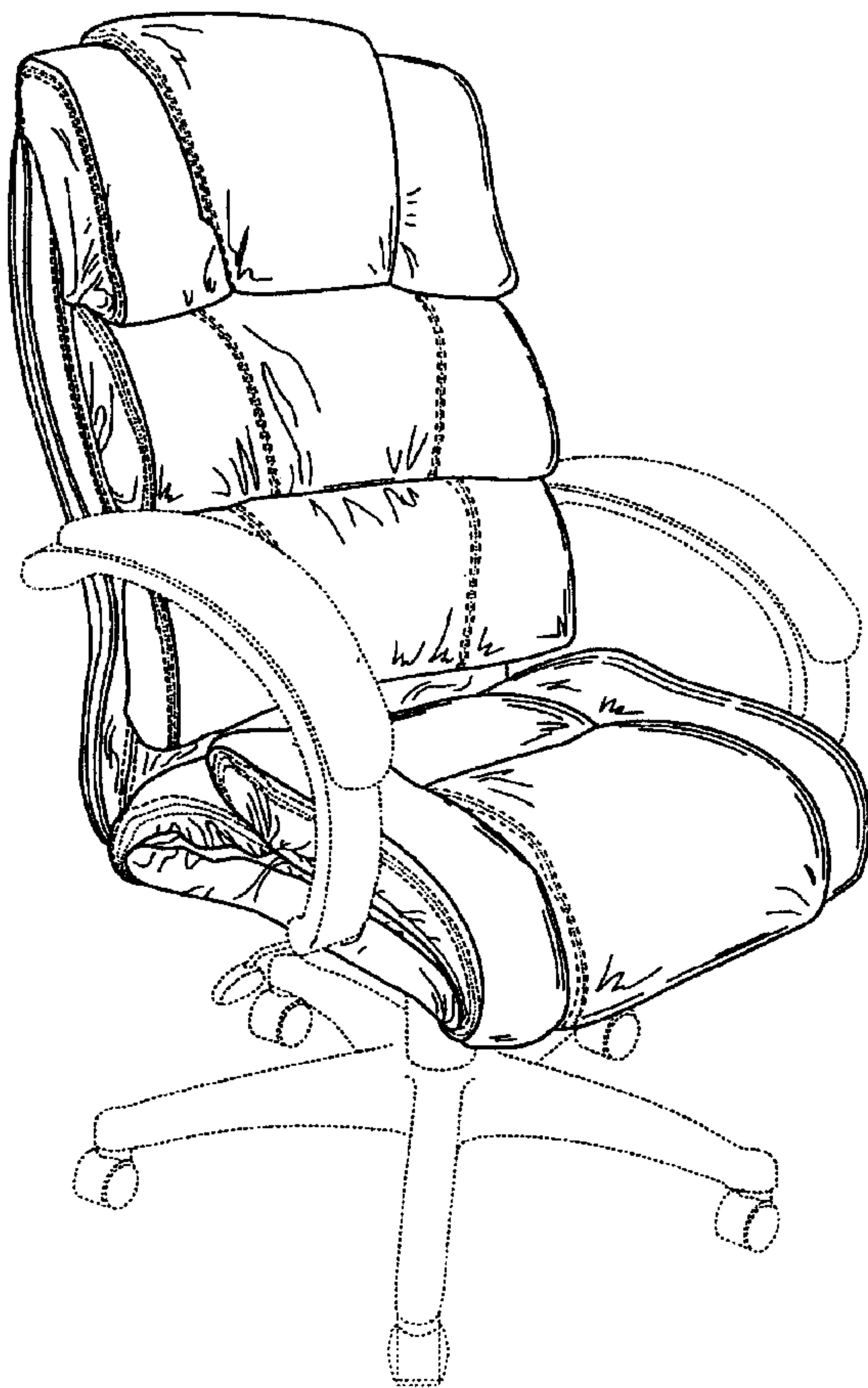

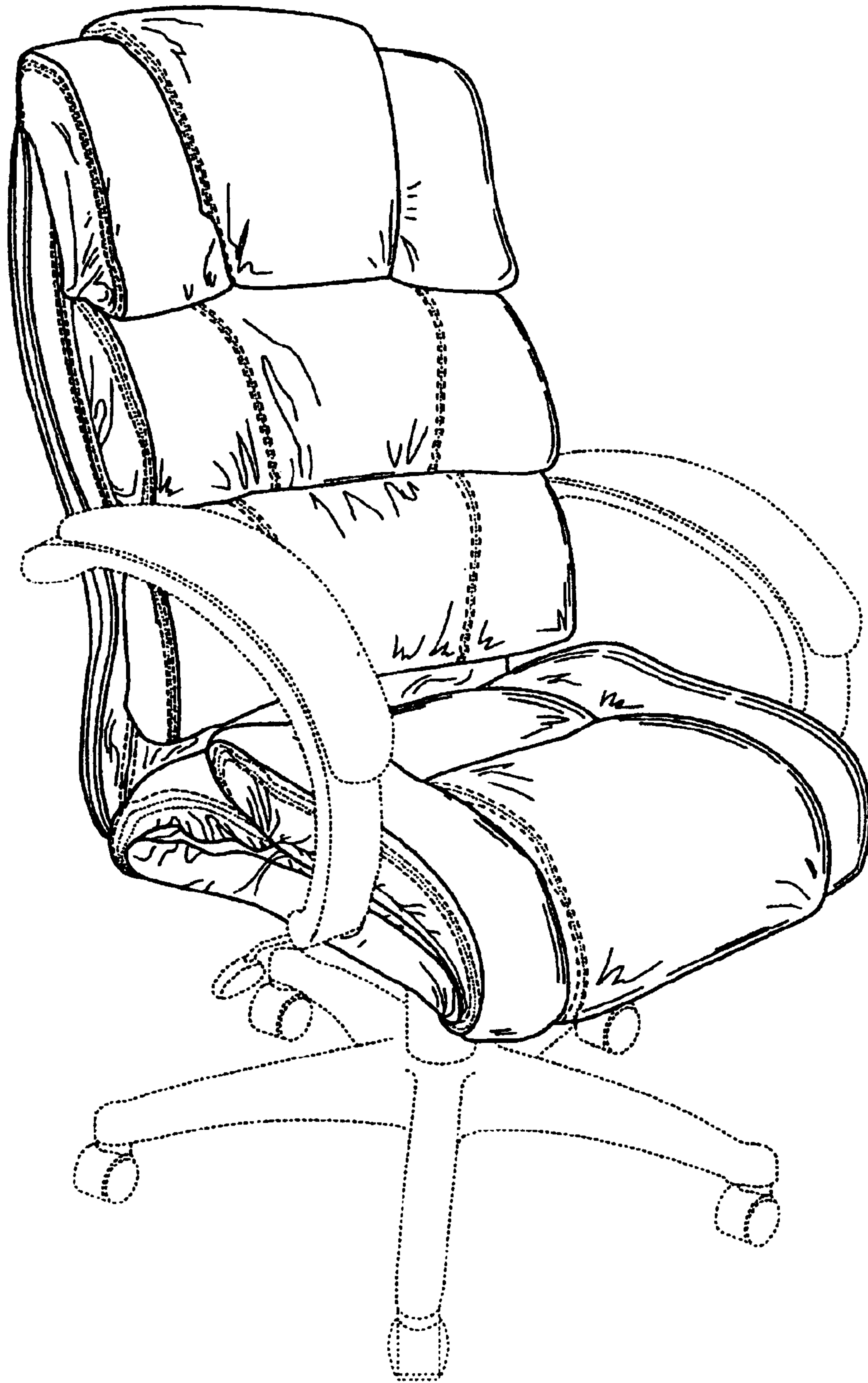

FIG. 1

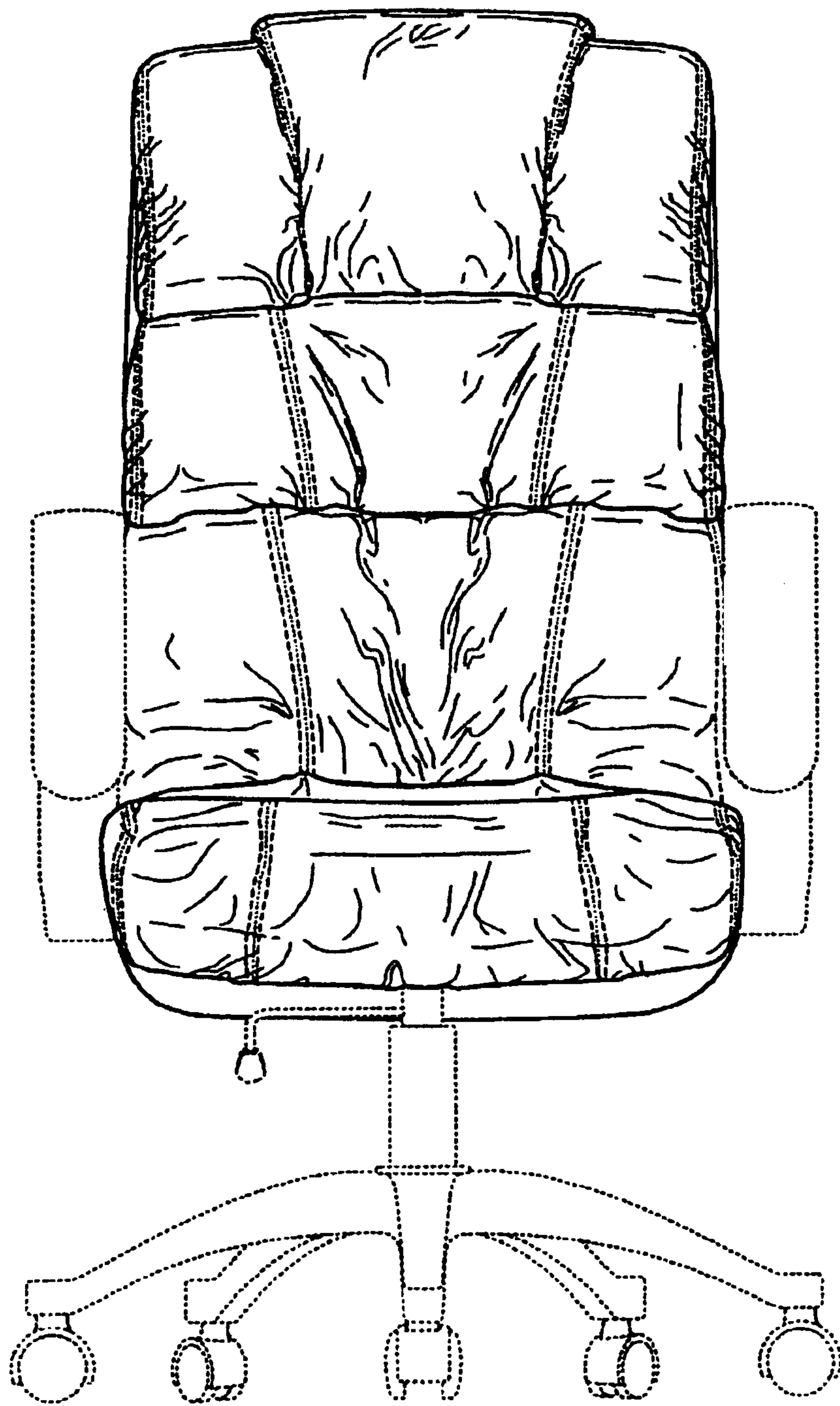

FIG. 2

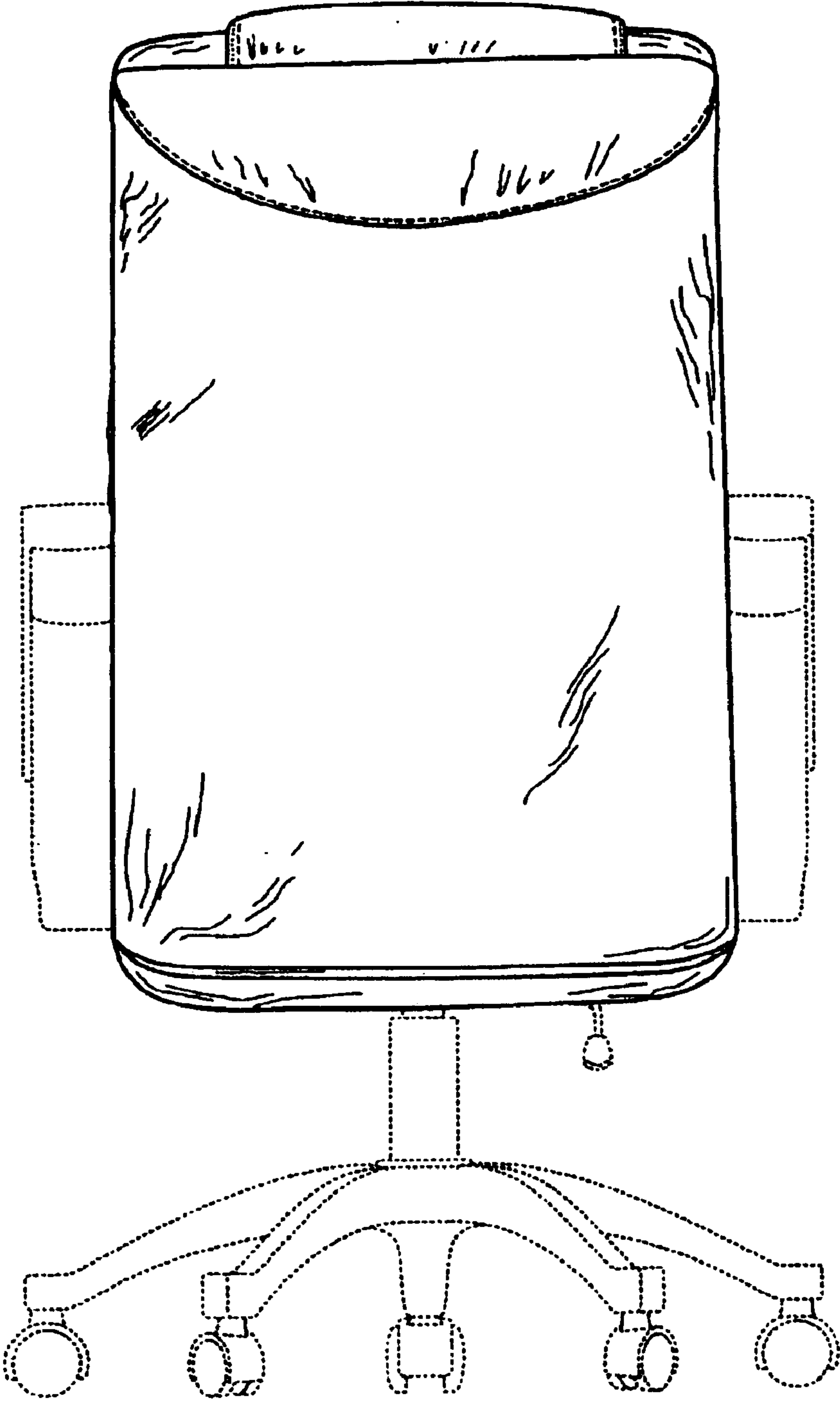

FIG. 3

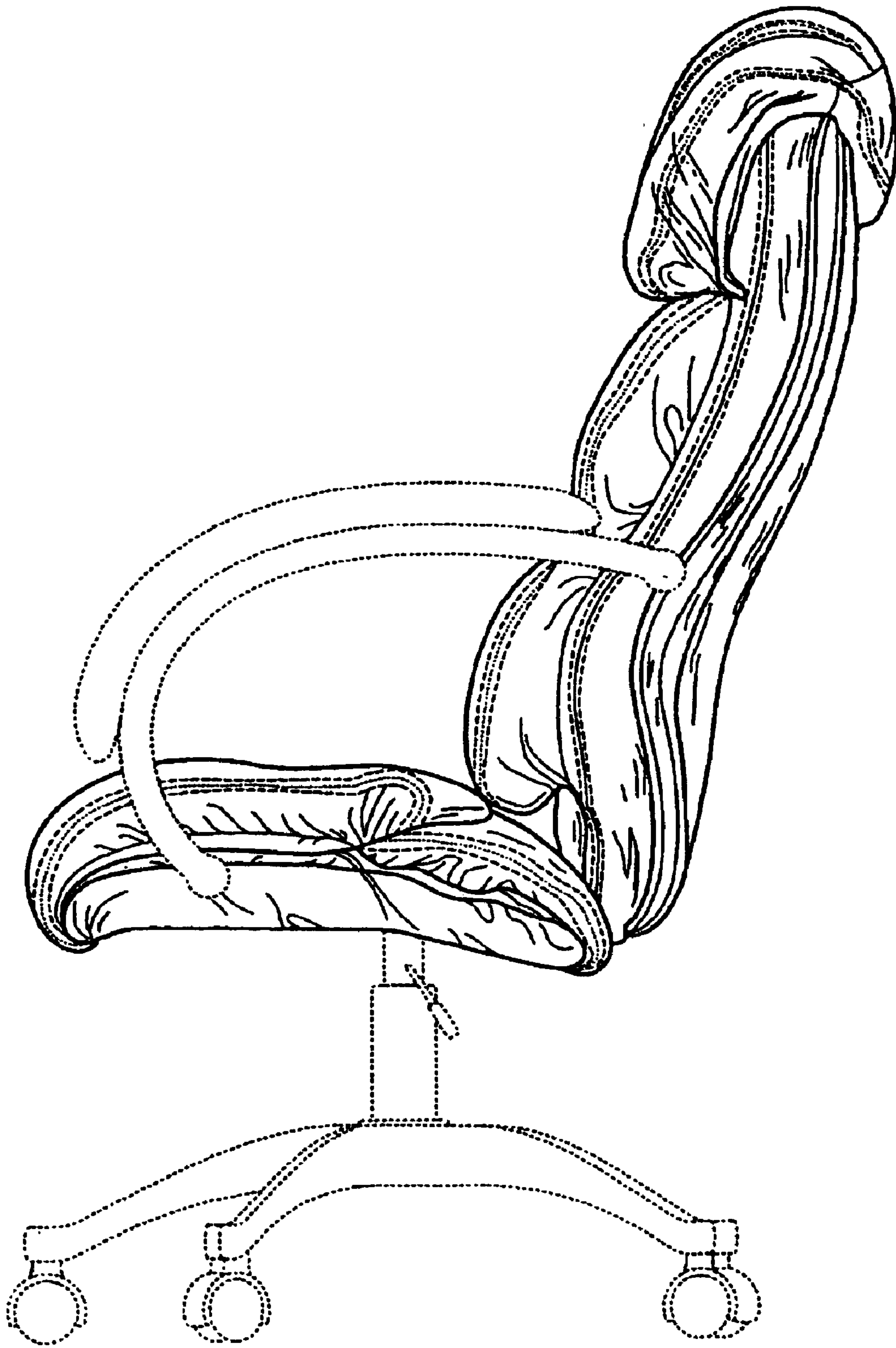

FIG. 4

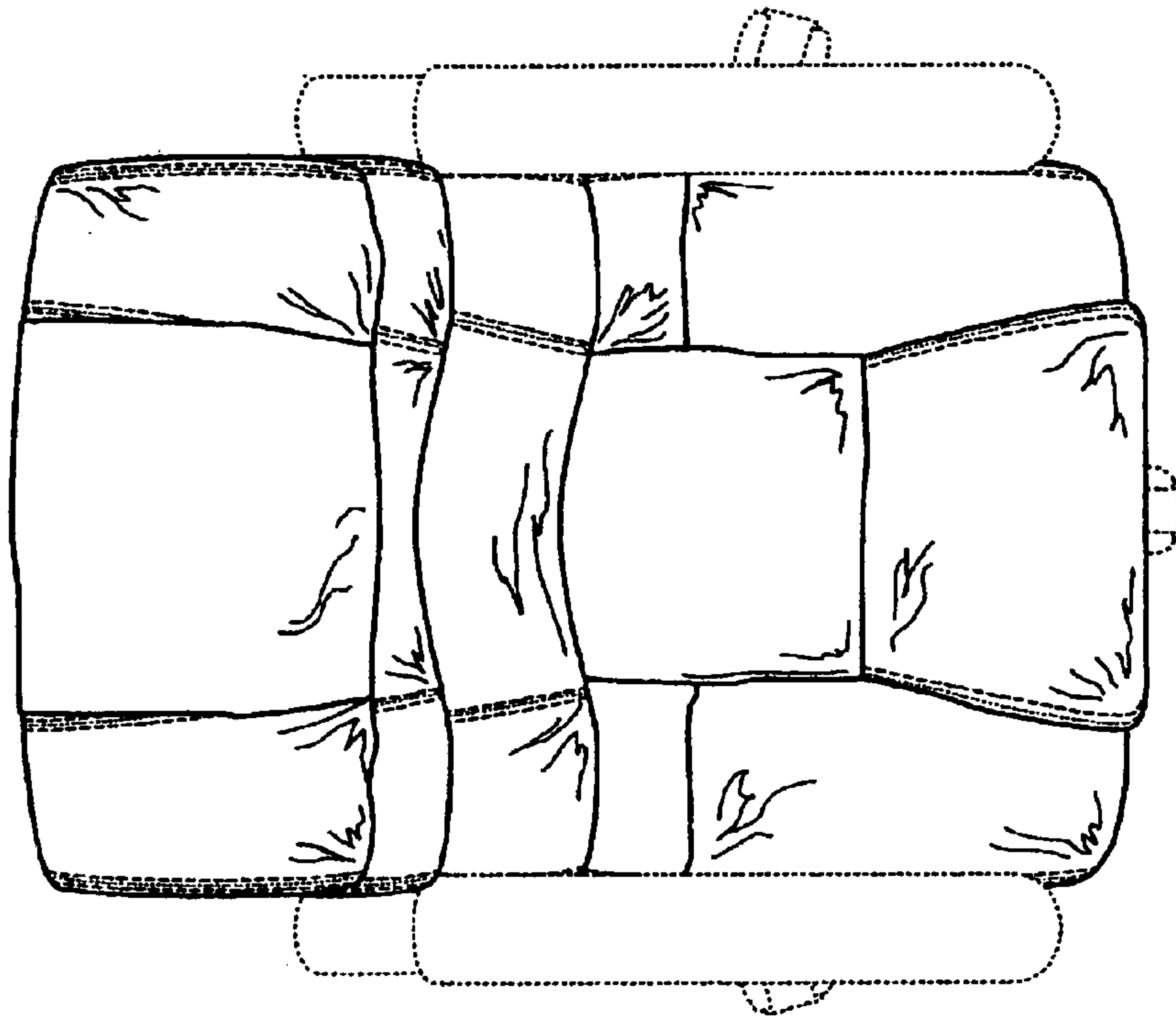

FIG. 5

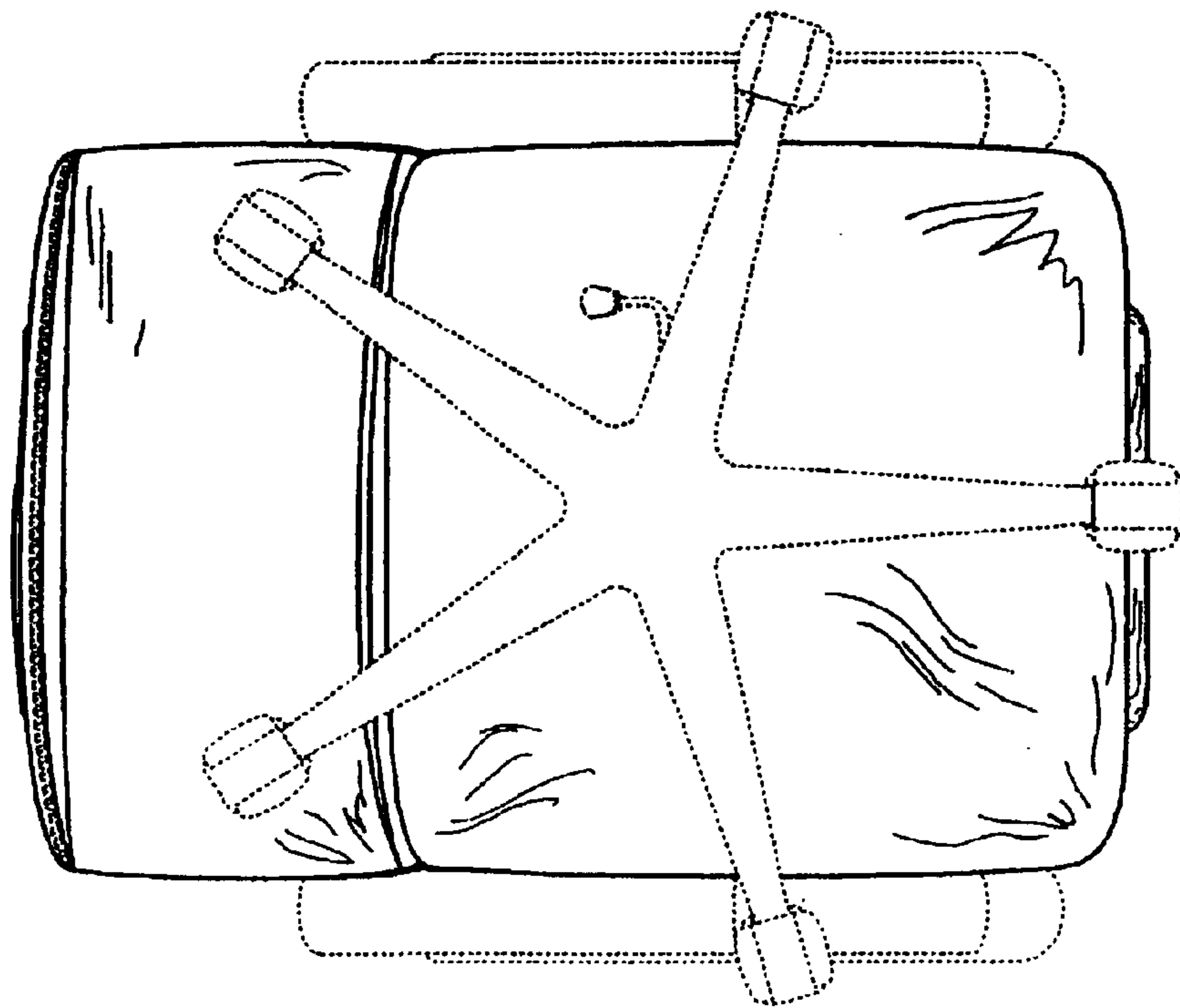

FIG. 6