



US00D540051S

(12) **United States Design Patent**
Florez et al.

(10) **Patent No.:** **US D540,051 S**

(45) **Date of Patent:** **** Apr. 10, 2007**

(54) **CHAIR**

(75) Inventors: **Richard E. Florez**, Pittsburg, CA (US);
Raymond Jamie Duran, Brentwood,
CA (US); **Leonard L. Hofheins**, Provo,
UT (US)

(73) Assignee: **Ultimate Game Chair**, Concord, CA
(US)

(**) Term: **14 Years**

(21) Appl. No.: **29/258,410**

(22) Filed: **Apr. 21, 2006**

(51) **LOC (8) Cl.** **06-01**

(52) **U.S. Cl.** **D6/367**

(58) **Field of Classification Search** D6/334-336,
D6/360, 361, 367, 371, 373, 379, 492, 500-502;
297/68, 271.1, 271.2, 271.3, 411.45, 423.19,
297/423.3, 353, 354.1, 217.3; 601/49, 57-59,
601/97-99, 102, 115, 116, 148, 149

See application file for complete search history.

(56) **References Cited**

U.S. PATENT DOCUMENTS

D372,801 S * 8/1996 Fujimoto et al. D6/367
D372,802 S * 8/1996 Fujimoto et al. D6/367
D447,348 S * 9/2001 Kobayashi et al. D6/335

D462,190 S * 9/2002 Garcia D6/367
D471,372 S * 3/2003 Inada et al. D6/367
D476,492 S * 7/2003 Yamamoto et al. D6/335
D500,212 S * 12/2004 Potter D6/367
D500,608 S * 1/2005 Potter et al. D6/367
D500,609 S * 1/2005 Potter D6/367
D501,097 S * 1/2005 Bruning D6/367
D508,617 S * 8/2005 Potter D6/367
D517,338 S * 3/2006 Inada et al. D6/367
2005/0168021 A1 * 8/2005 Real et al. 297/217.3

* cited by examiner

Primary Examiner—Mimosa De

(74) *Attorney, Agent, or Firm*—Brown Raysman Millstein
Felder & Steiner, LLP

(57) **CLAIM**

We claim the ornamental design for a chair, as shown.

DESCRIPTION

FIG. 1 is a front 3-D perspective view of the chair incor-
porating our new design.

FIG. 2 is a front view thereof;

FIG. 3 is a left side view thereof;

FIG. 4 is a right side view thereof;

FIG. 5 is a rear view thereof;

FIG. 6 is a top view thereof; and,

FIG. 7 is a bottom view thereof.

1 Claim, 7 Drawing Sheets

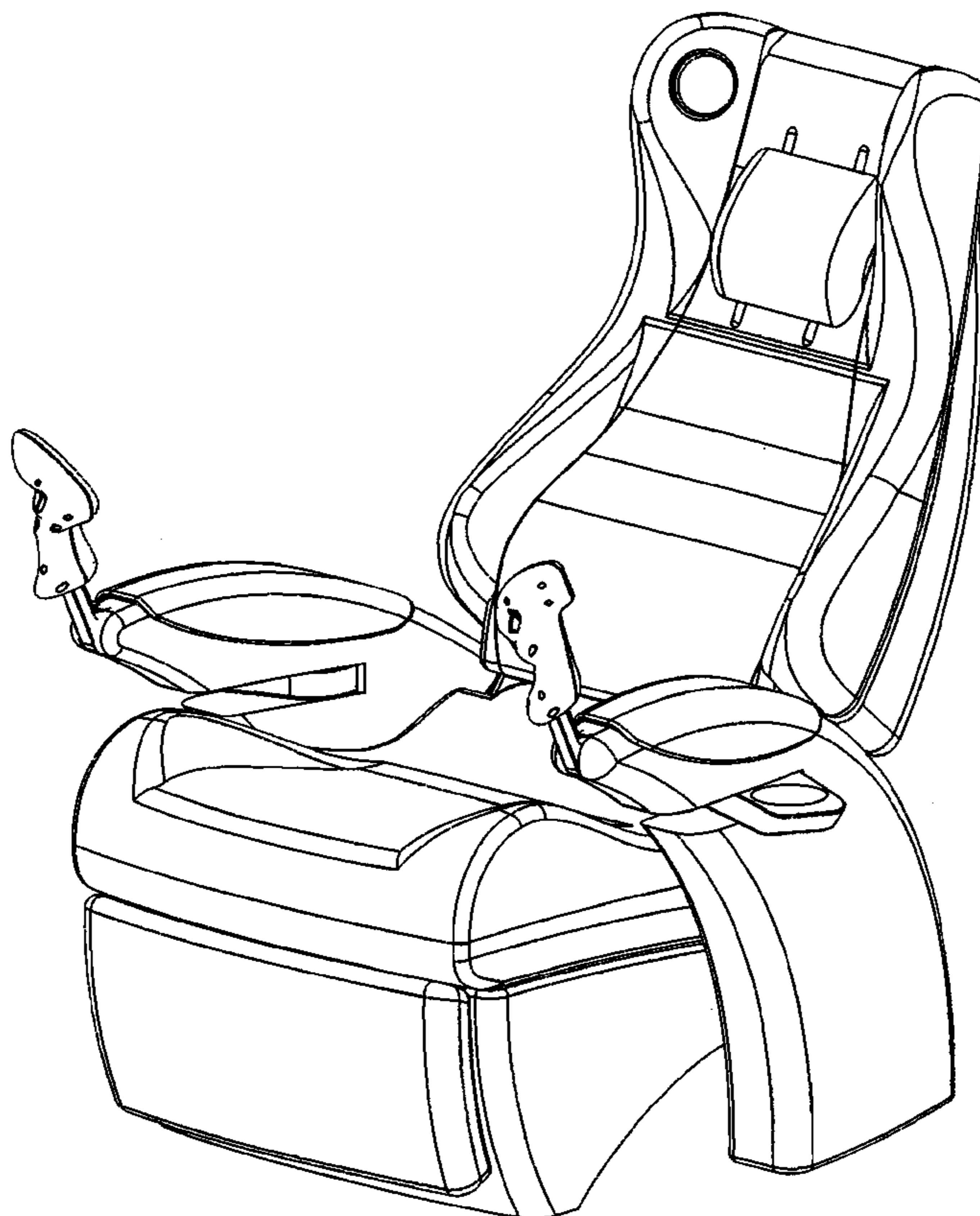

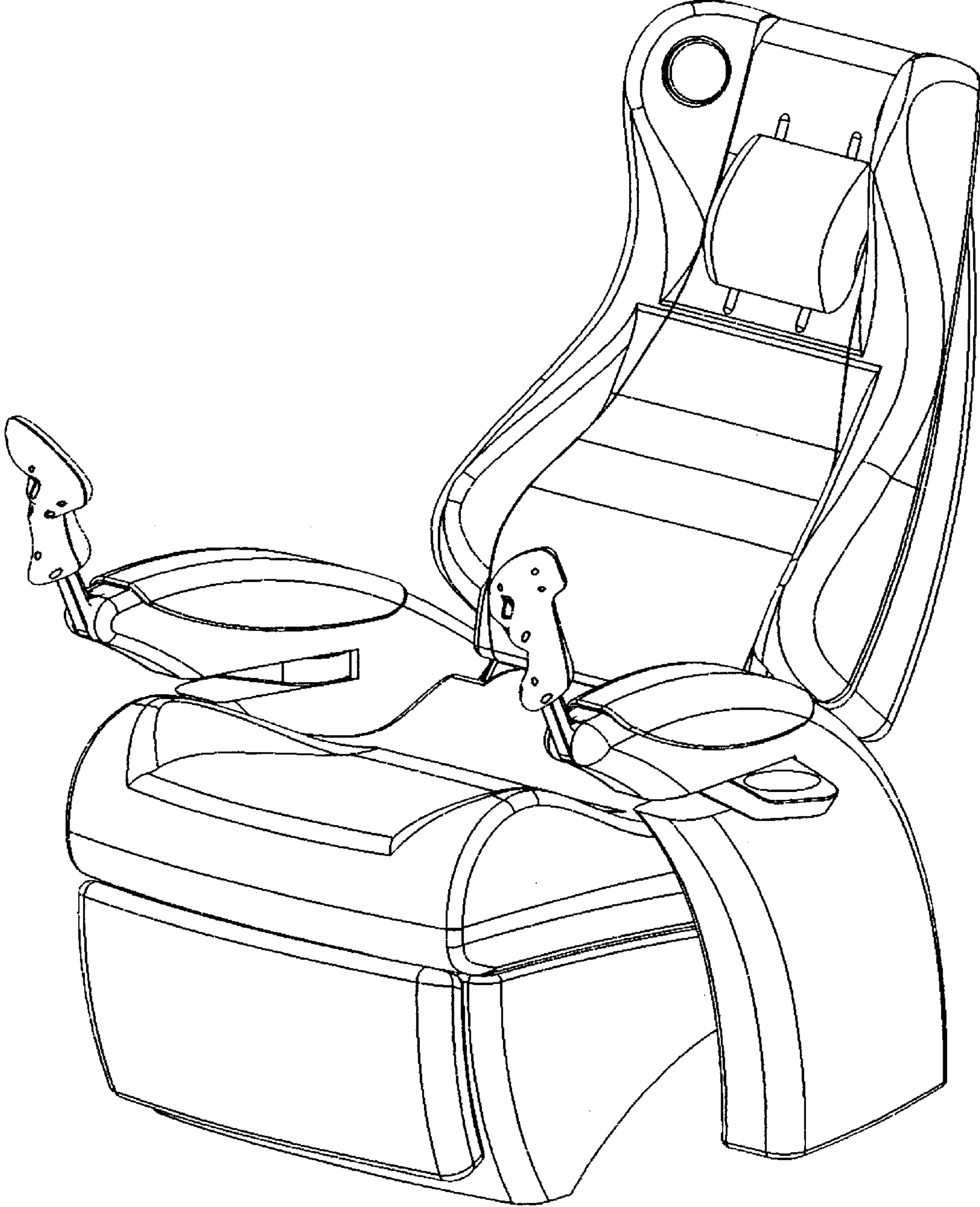

Fig. 1

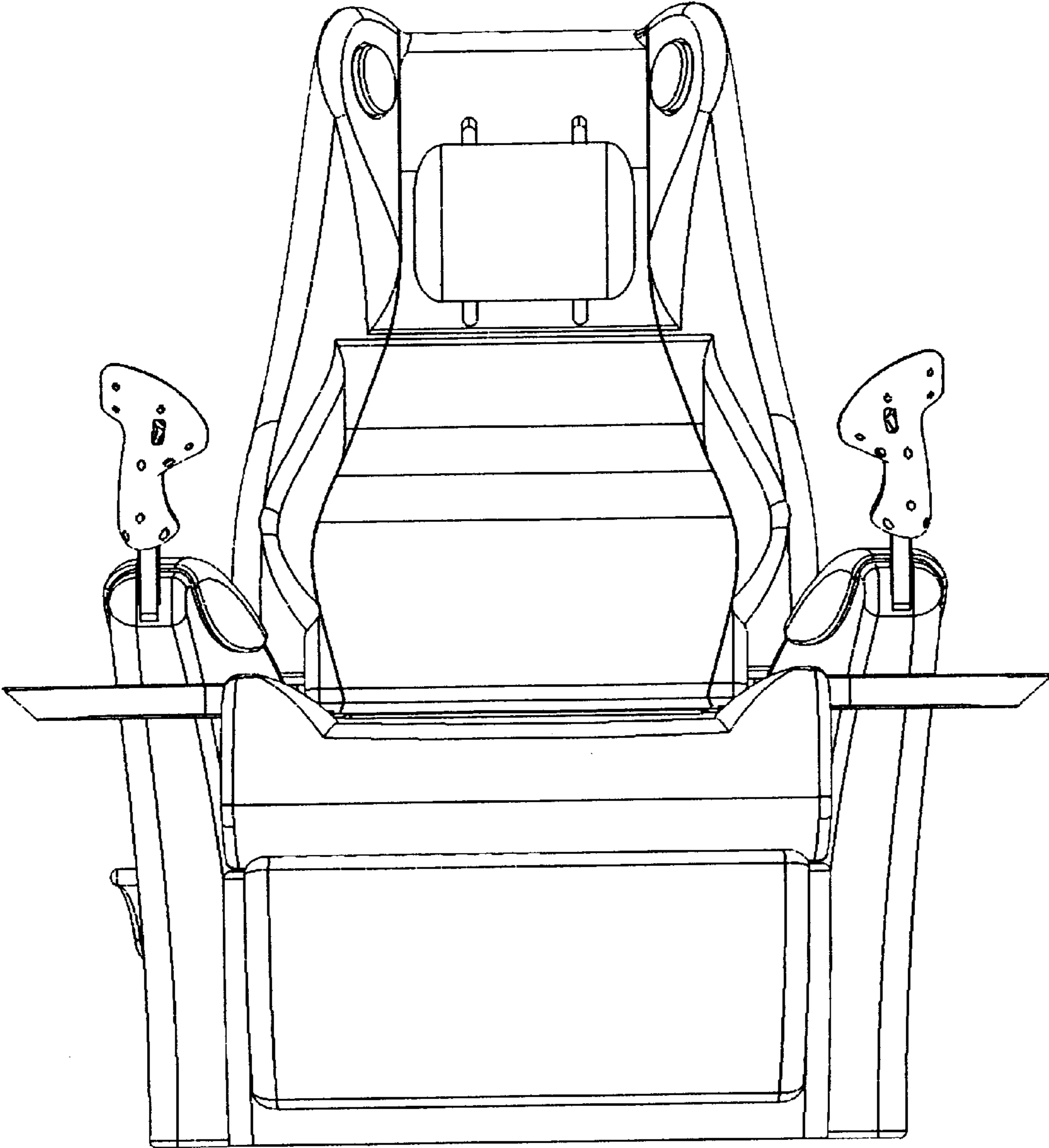

Fig. 2

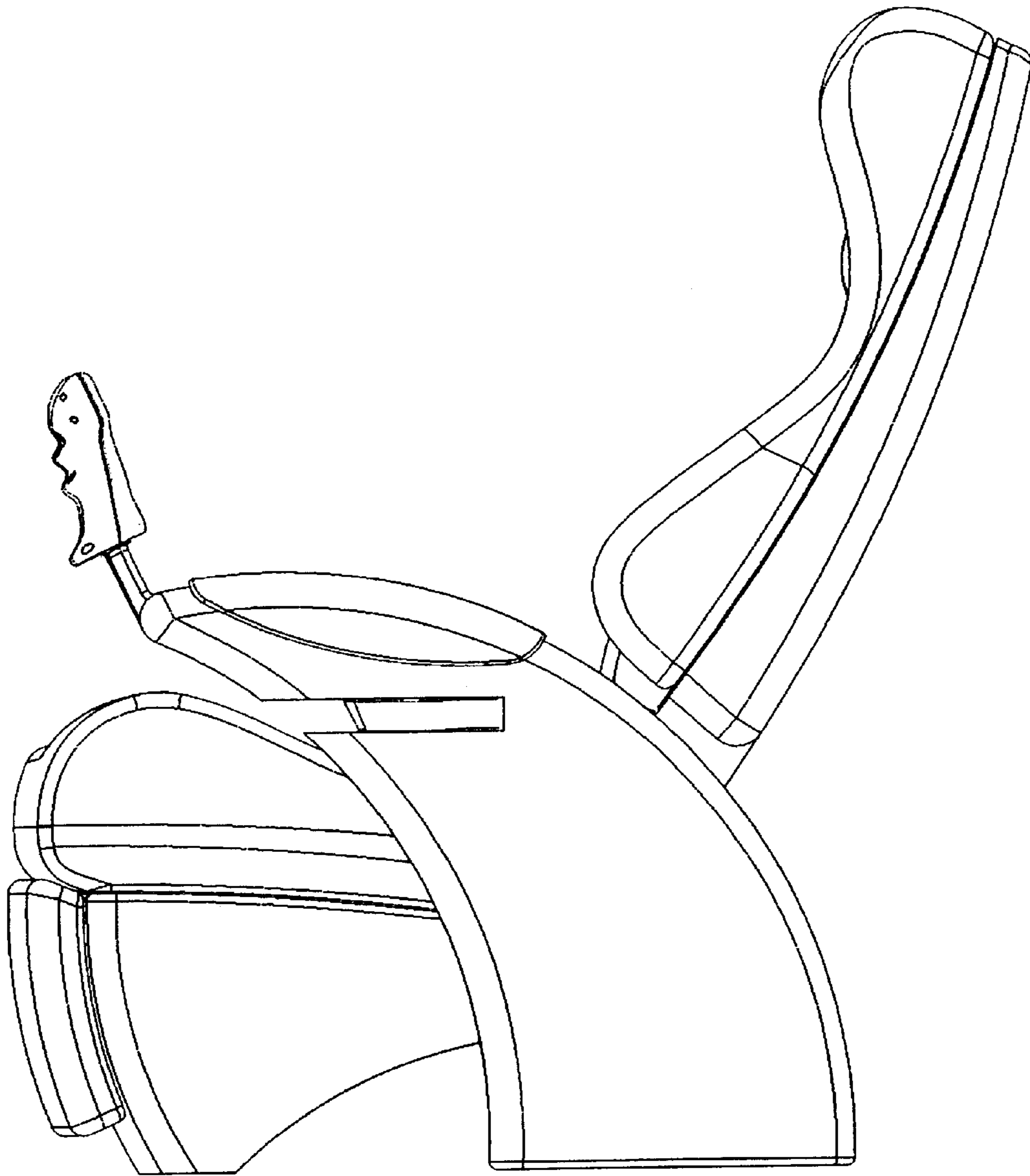

Fig. 3

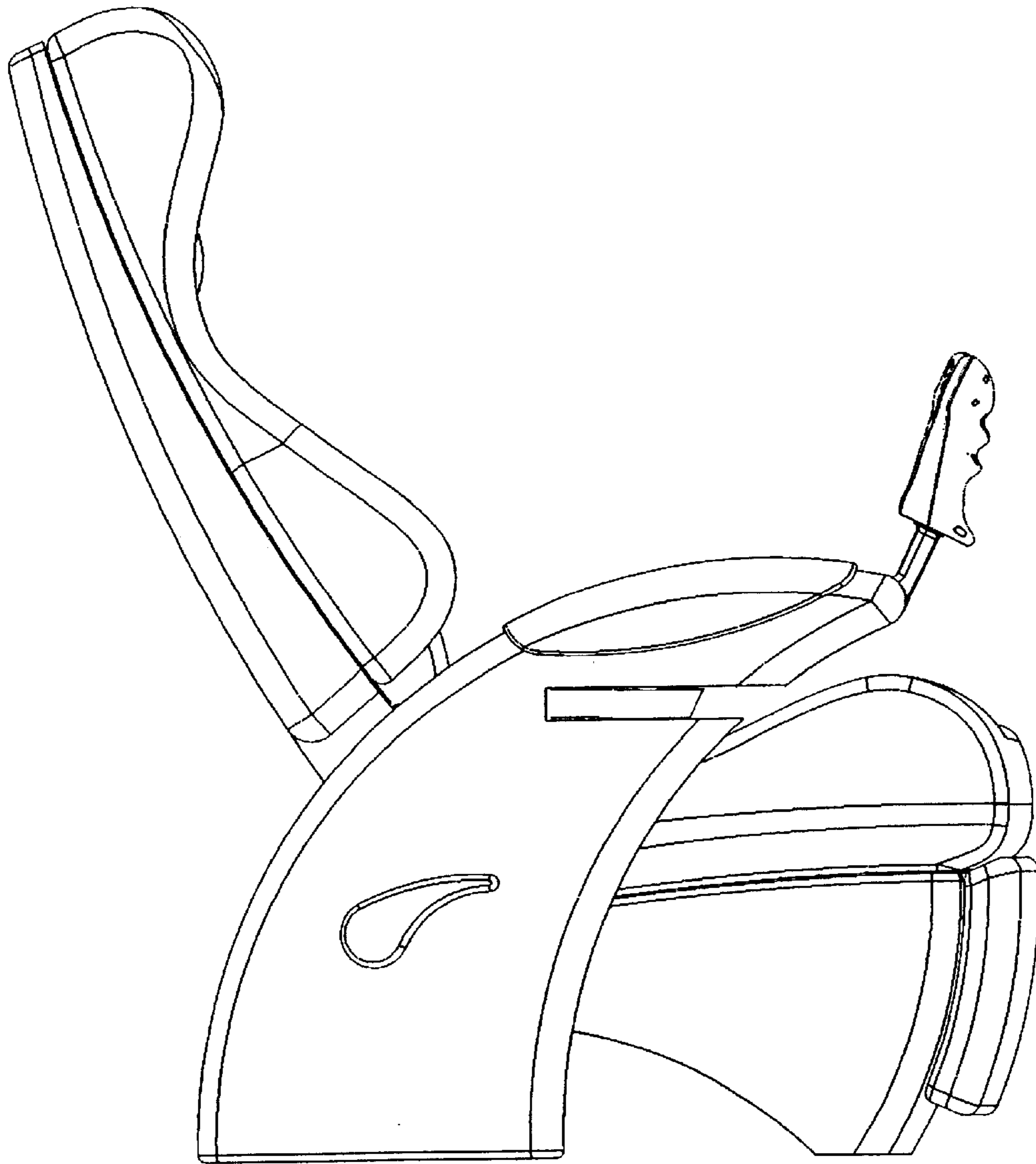

Fig. 4

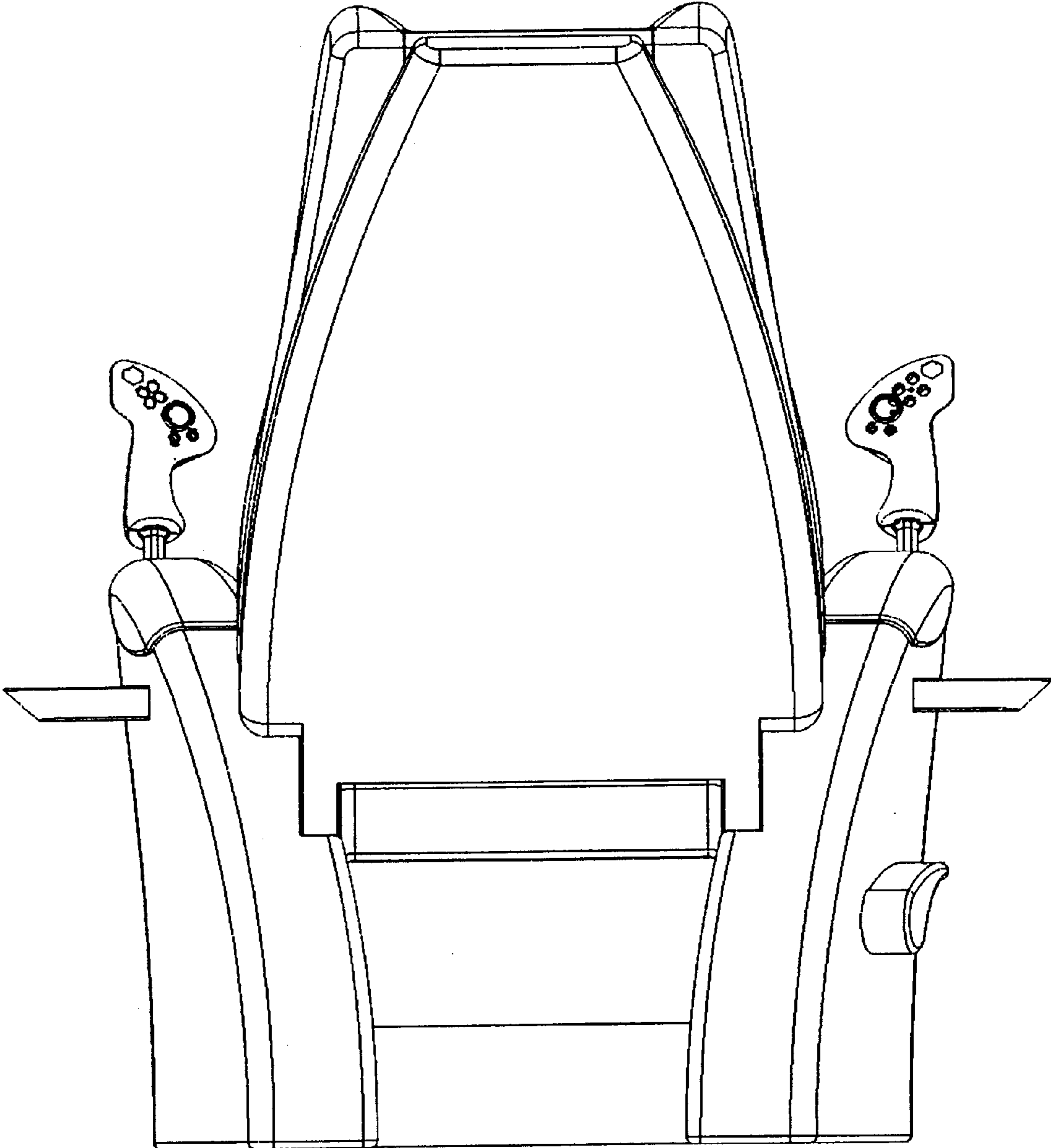

Fig. 5

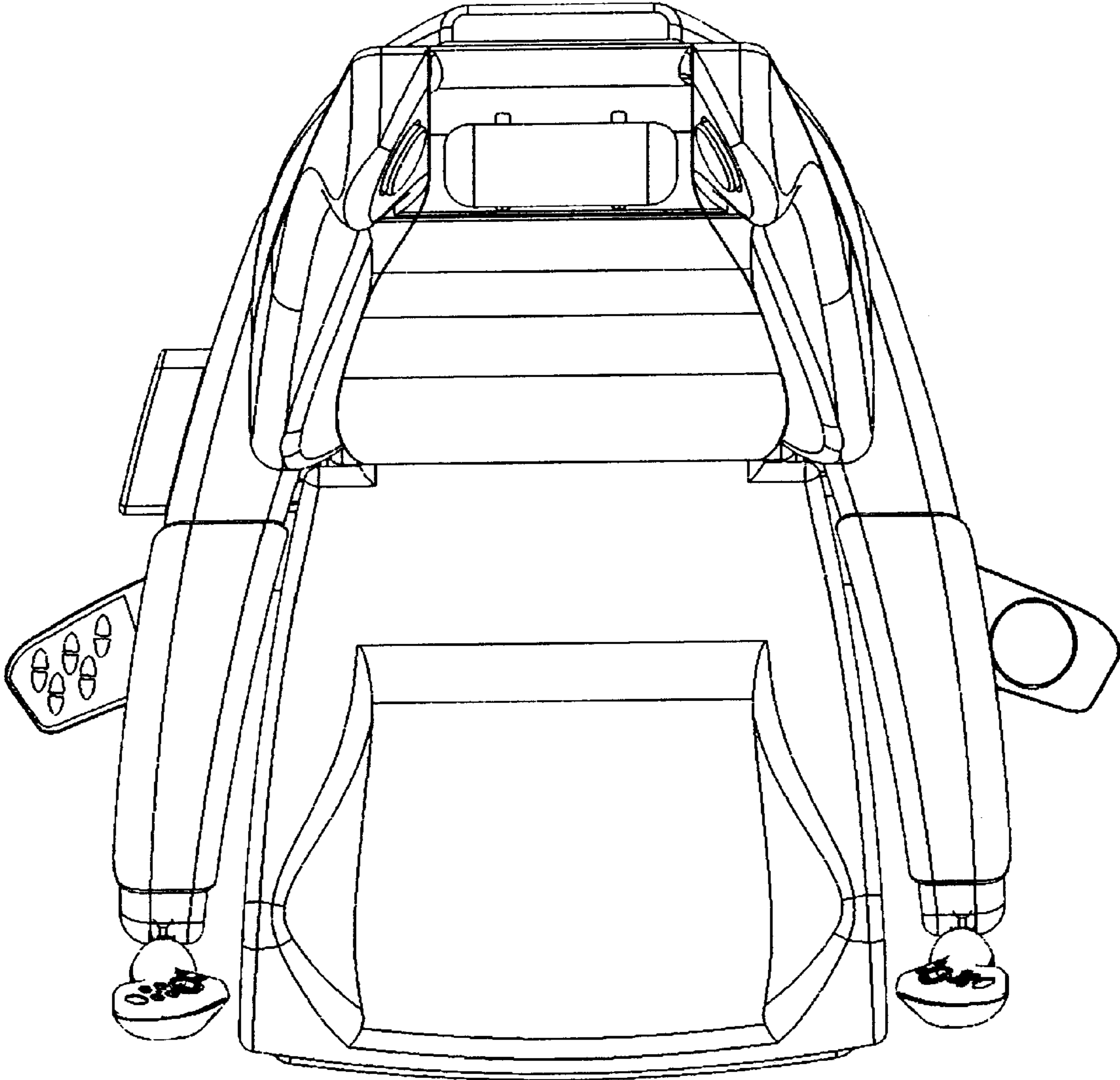

Fig. 6

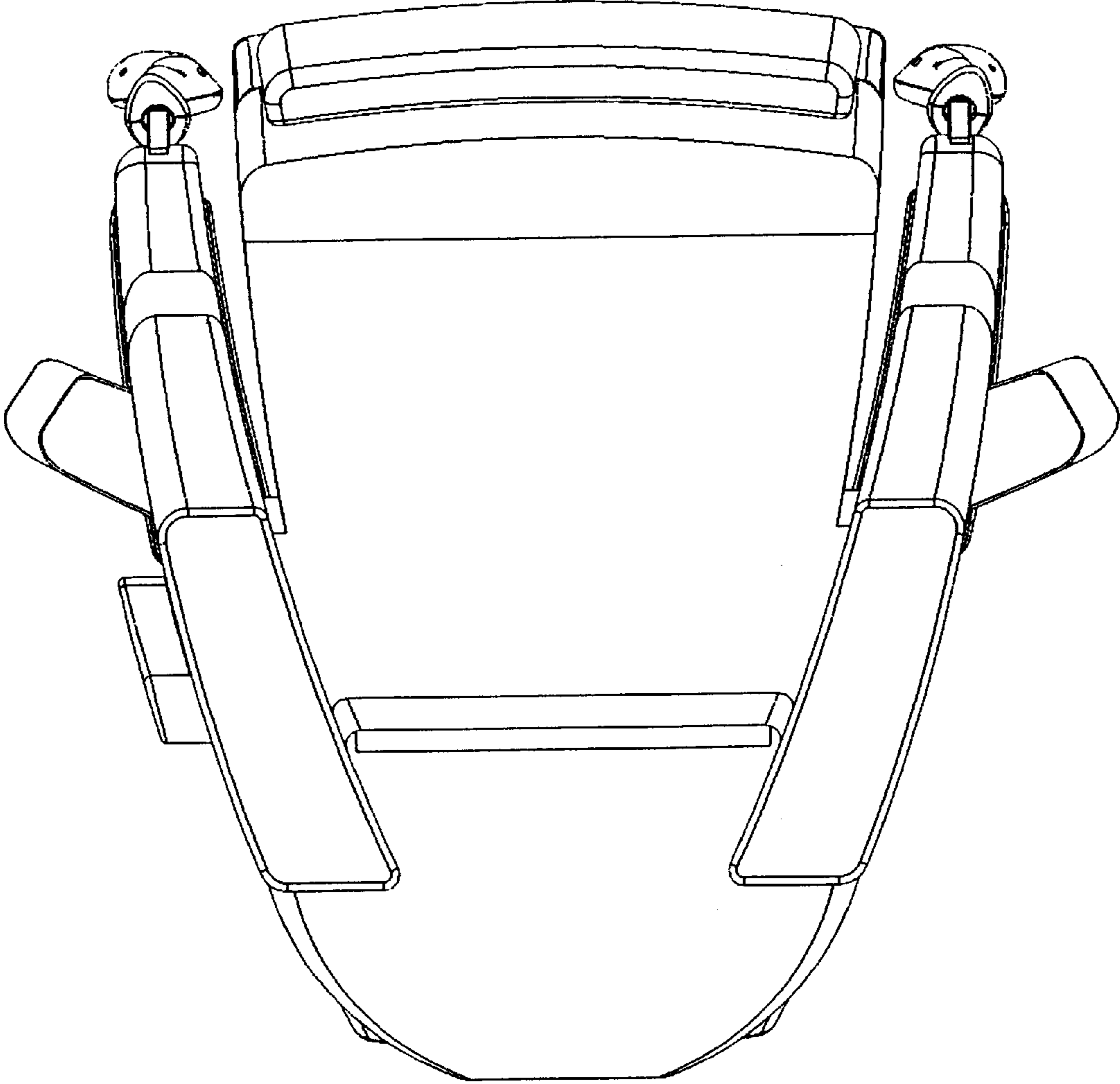

Fig. 7