

US00D540043S

(12) **United States Design Patent**
Hay

(10) **Patent No.:** **US D540,043 S**
(45) **Date of Patent:** **** Apr. 10, 2007**

(54) **CLEANING IMPLEMENT**

(75) Inventor: **Christopher James Mccaughan Hay**,
Cause Bay (HK)

(73) Assignee: **Hayco Manufacturing Limited**,
Causeway Bay (HK)

(**) Term: **14 Years**

(21) Appl. No.: **29/223,163**

(22) Filed: **Feb. 9, 2005**

(51) **LOC (8) Cl.** **04-01**

(52) **U.S. Cl.** **D4/199; D4/130**

(58) **Field of Classification Search** D4/130,
D4/135, 138, 199; D32/52; 15/159.1, 160,
15/186-188, 191.1, 192, 193

See application file for complete search history.

(56) **References Cited**

U.S. PATENT DOCUMENTS

- D283,851 S * 5/1986 Walko D4/130
- D477,149 S * 7/2003 Hay D4/130
- D480,219 S * 10/2003 Mastroianni D4/138
- D493,287 S * 7/2004 Hay et al. D4/130

OTHER PUBLICATIONS

Hong Kong Enterprise, vol. 10, [online], Oct. 2002, Marco Home Products Ltd., Brush—Item 60104, [retrieved on Mar. 18, 2005] Retrieved from the Internet: <URL: <http://emag.hkenterprise.com>>.*

Hong Kong Enterprise, vol. 10, [online], Oct. 2002, E & J (HK) Co. Ltd., Brush—Item F-1700, [retrieved on Mar. 18, 2005] Retrieved from the Internet: <URL: <http://emag.hkenterprise.com>>.*

* cited by examiner

Primary Examiner—Alan P. Douglas
Assistant Examiner—Lavone D. Tabor
(74) *Attorney, Agent, or Firm*—Smith-Hill and Bedell

(57) **CLAIM**

The ornamental design for a “cleaning implement,” as shown and described.

DESCRIPTION

FIG. 1 is a front perspective view showing one embodiment of a “cleaning implement” incorporating the design of my invention;

FIG. 2 is a top view thereof;

FIG. 3 is a bottom view thereof;

FIG. 4 is a side view thereof;

FIG. 5 is another side view thereof;

FIG. 6 is a front view thereof;

FIG. 7 is a rear view thereof;

FIG. 8 is a front perspective view showing another embodiment of a “cleaning implement” incorporating the design of my invention;

FIG. 9 is a top view of the cleaning implement shown in FIG. 8;

FIG. 10 is a bottom view of the cleaning implement shown in FIG. 8;

FIG. 11 is a side view of the cleaning implement shown in FIG. 8;

FIG. 12 is another side view of the cleaning implement shown in FIG. 8;

FIG. 13 is a front view of the cleaning implement shown in FIG. 8; and,

FIG. 14 is a rear view of the cleaning implement shown in FIG. 8.

The broken lines in FIGS. 1 to 14 showing bristles are for illustrative purposes only and form no part of the claimed design. The dotted area in FIGS. 8 to 14 illustrates different pattern or ornament used in that part of the design of the invention.

1 Claim, 14 Drawing Sheets

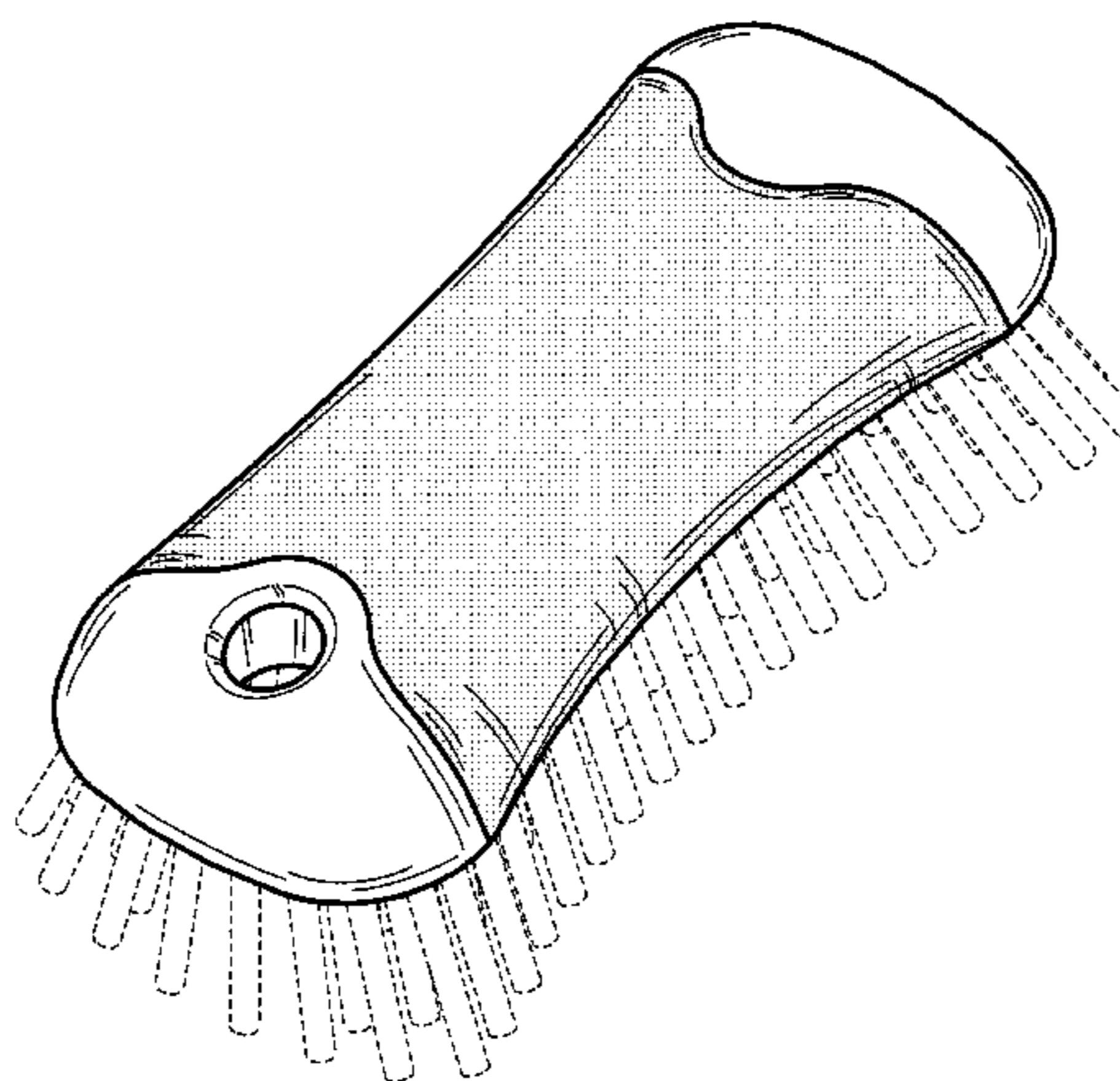
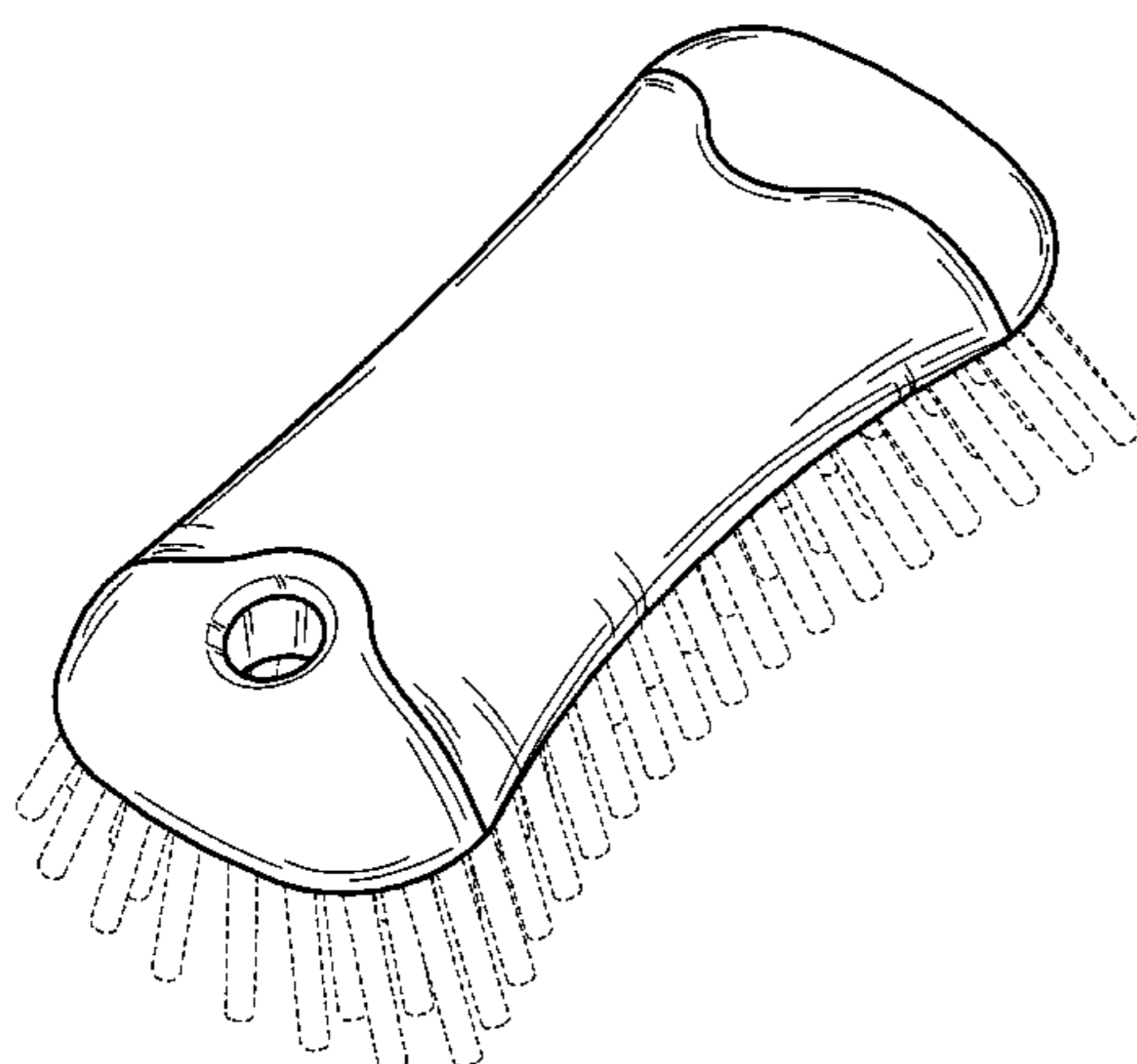

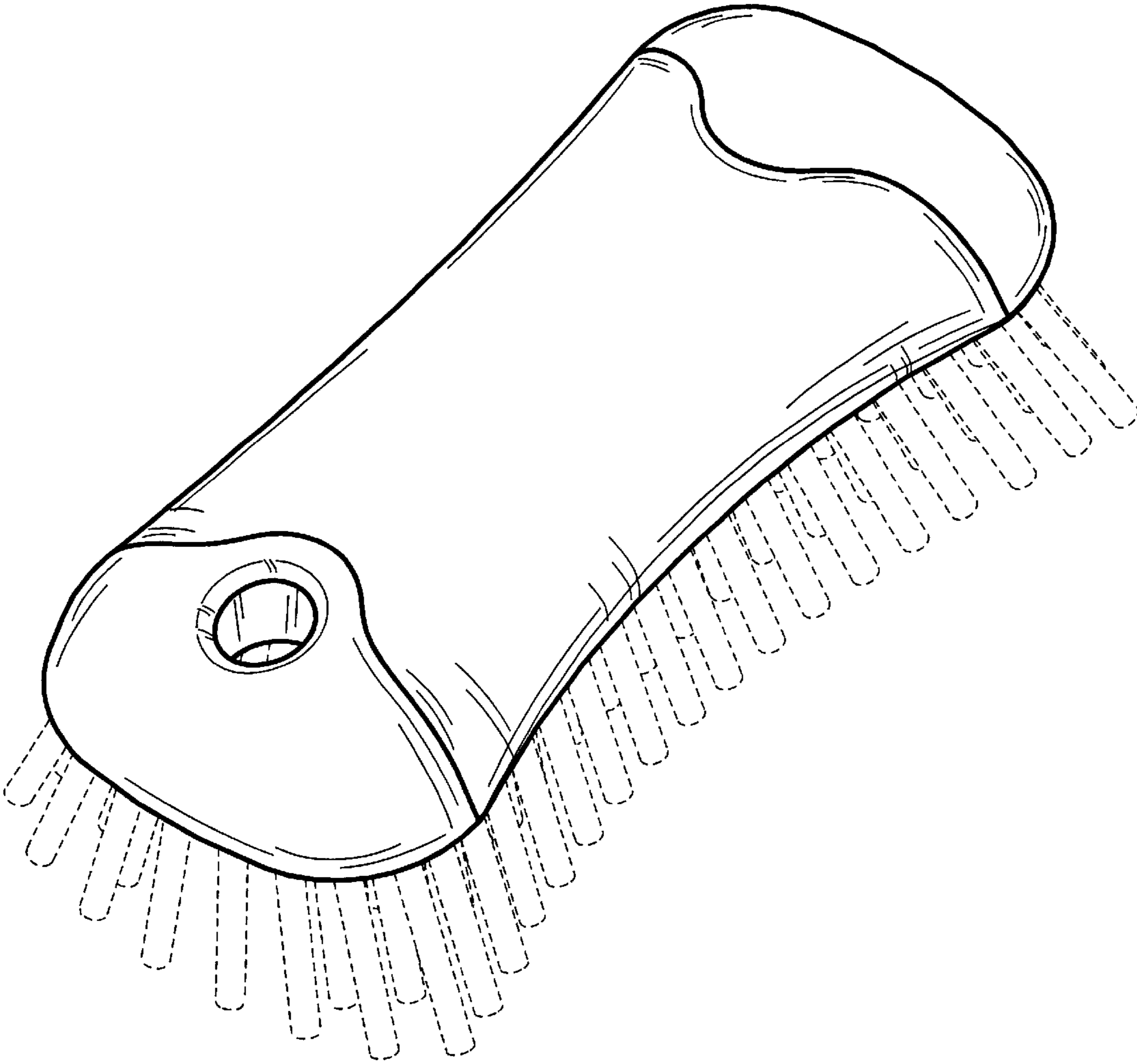

FIG:1

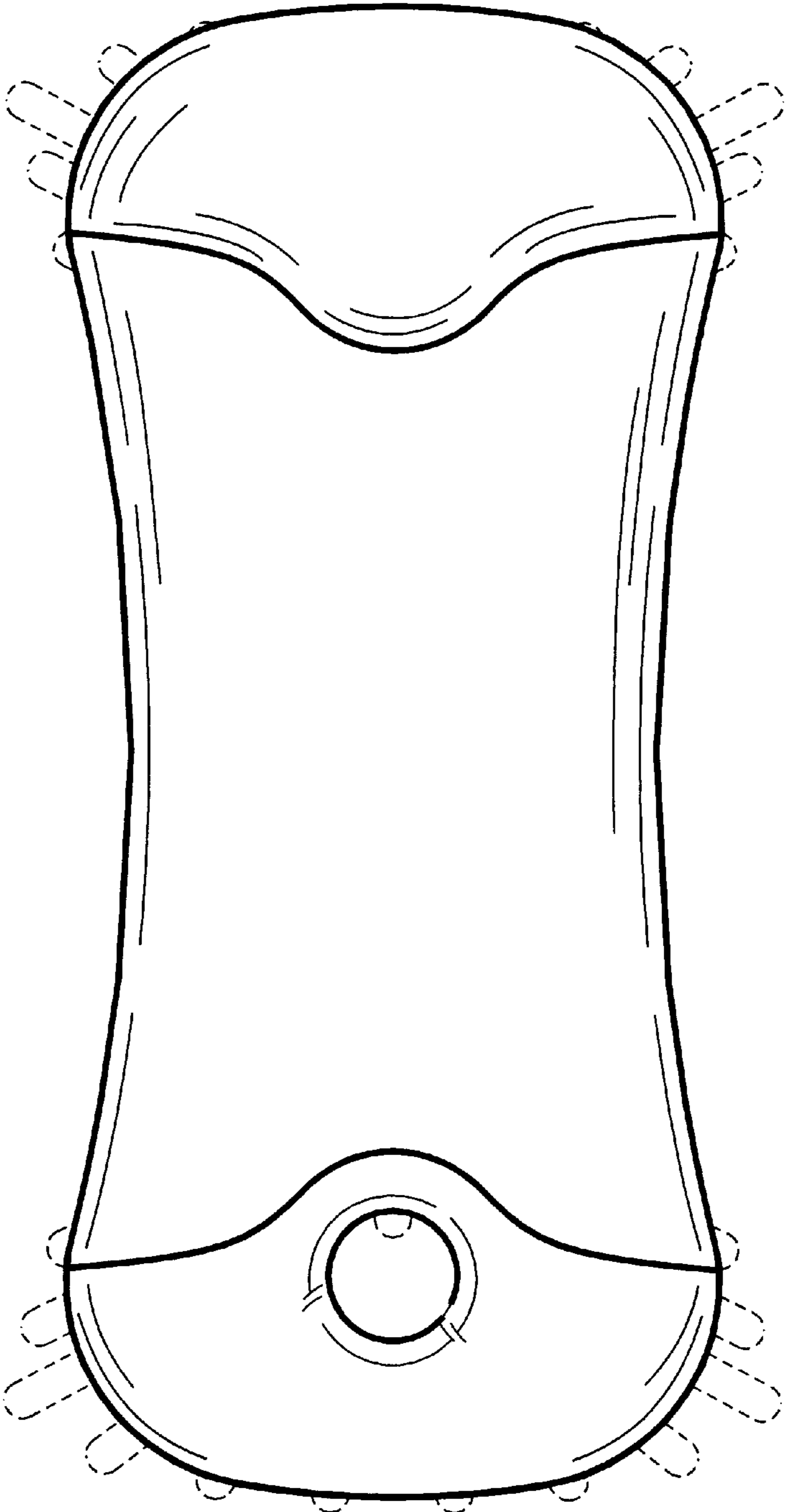

FIG:2

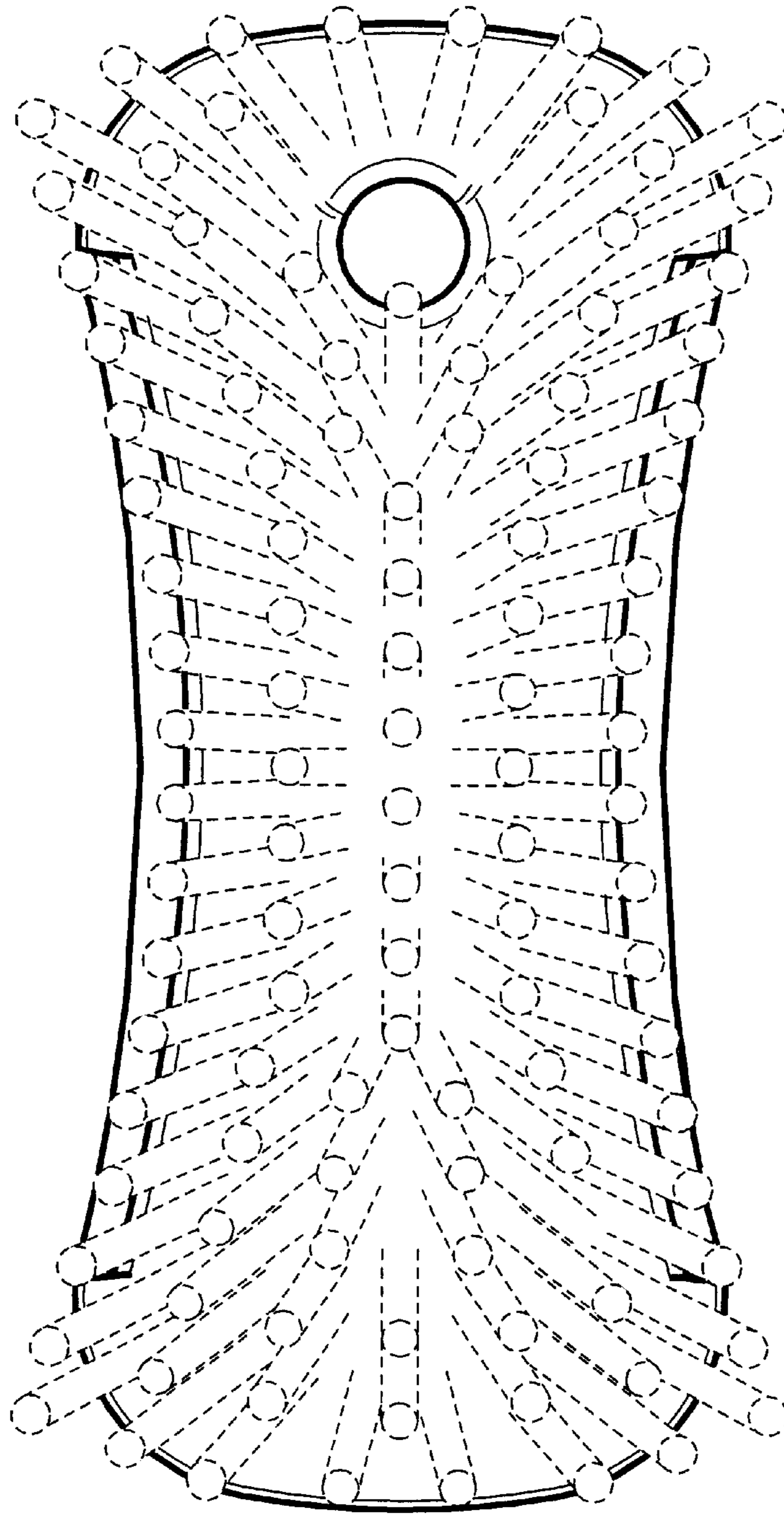

FIG:3

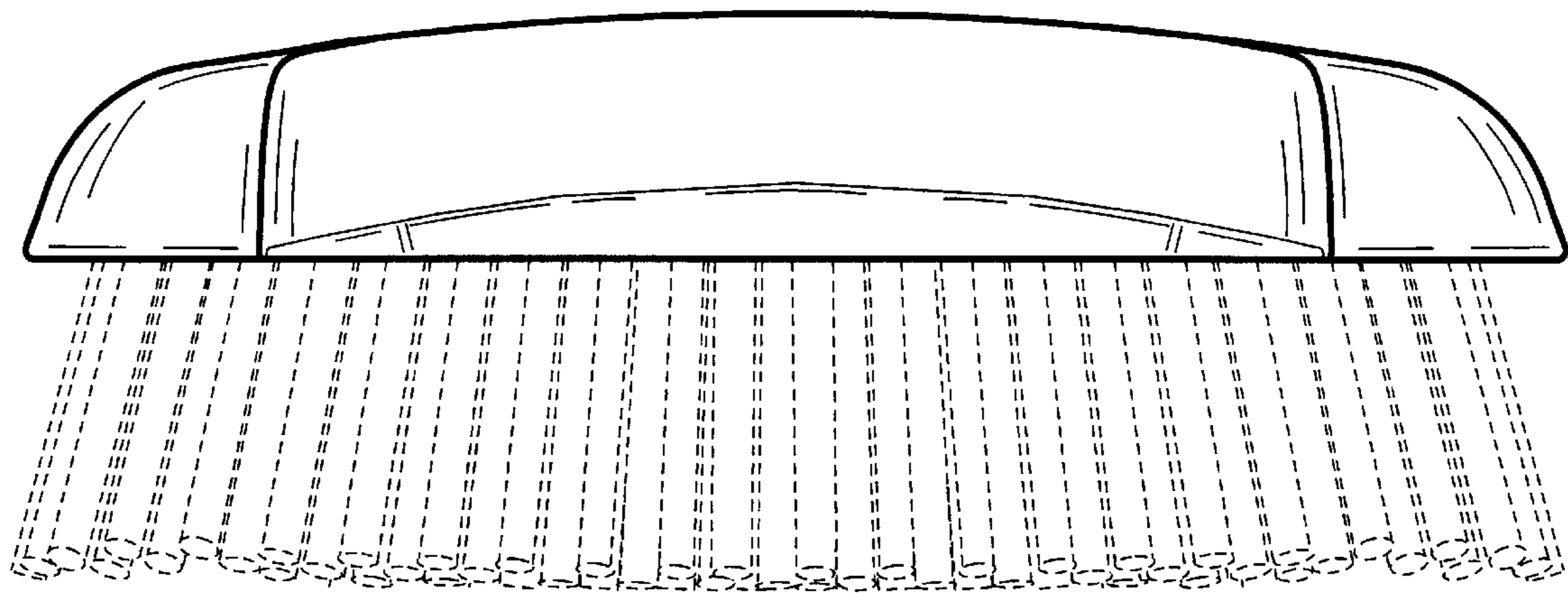

FIG:4

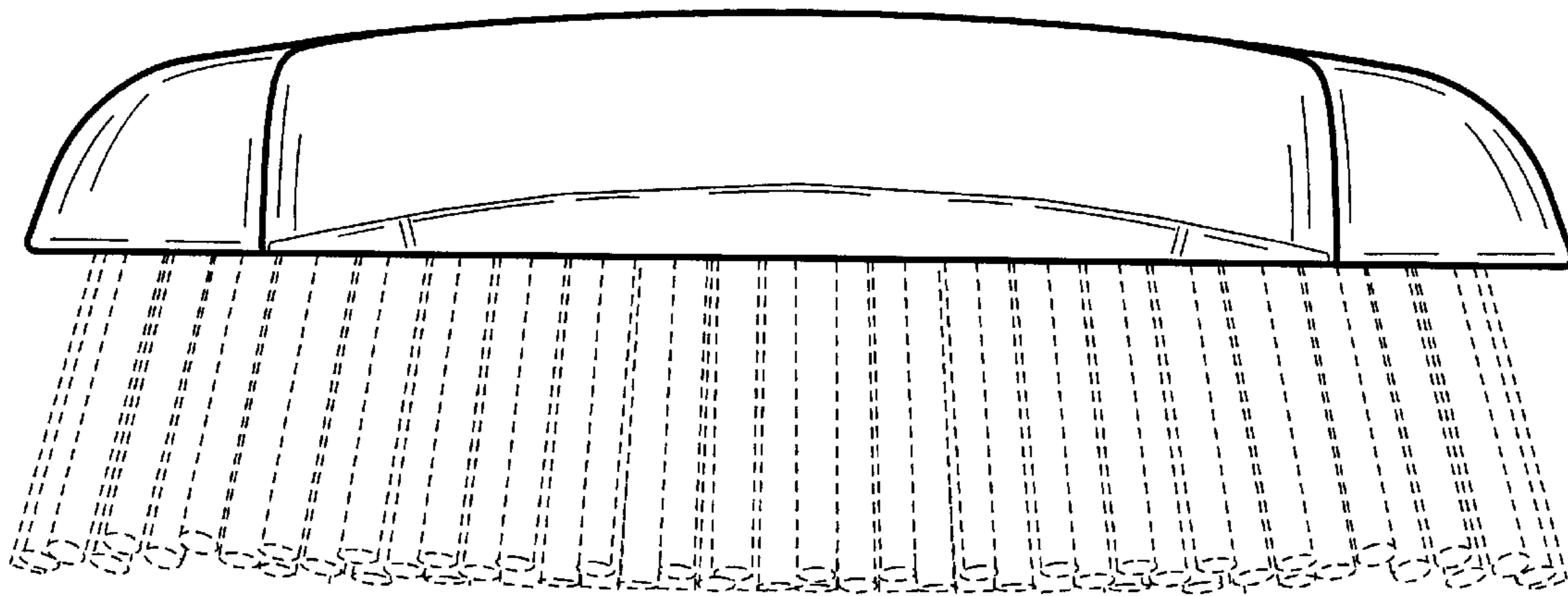

FIG:5

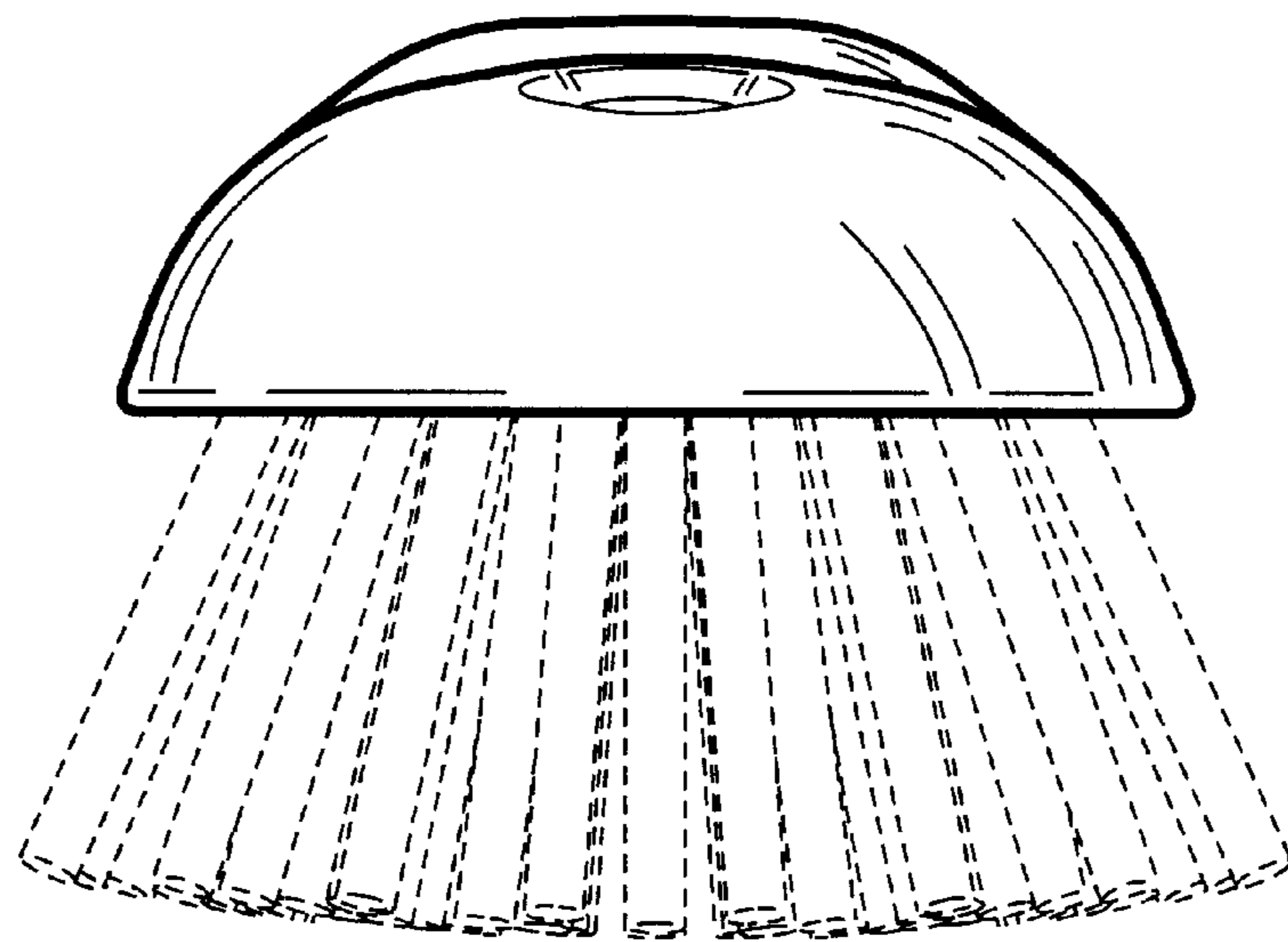

FIG:6

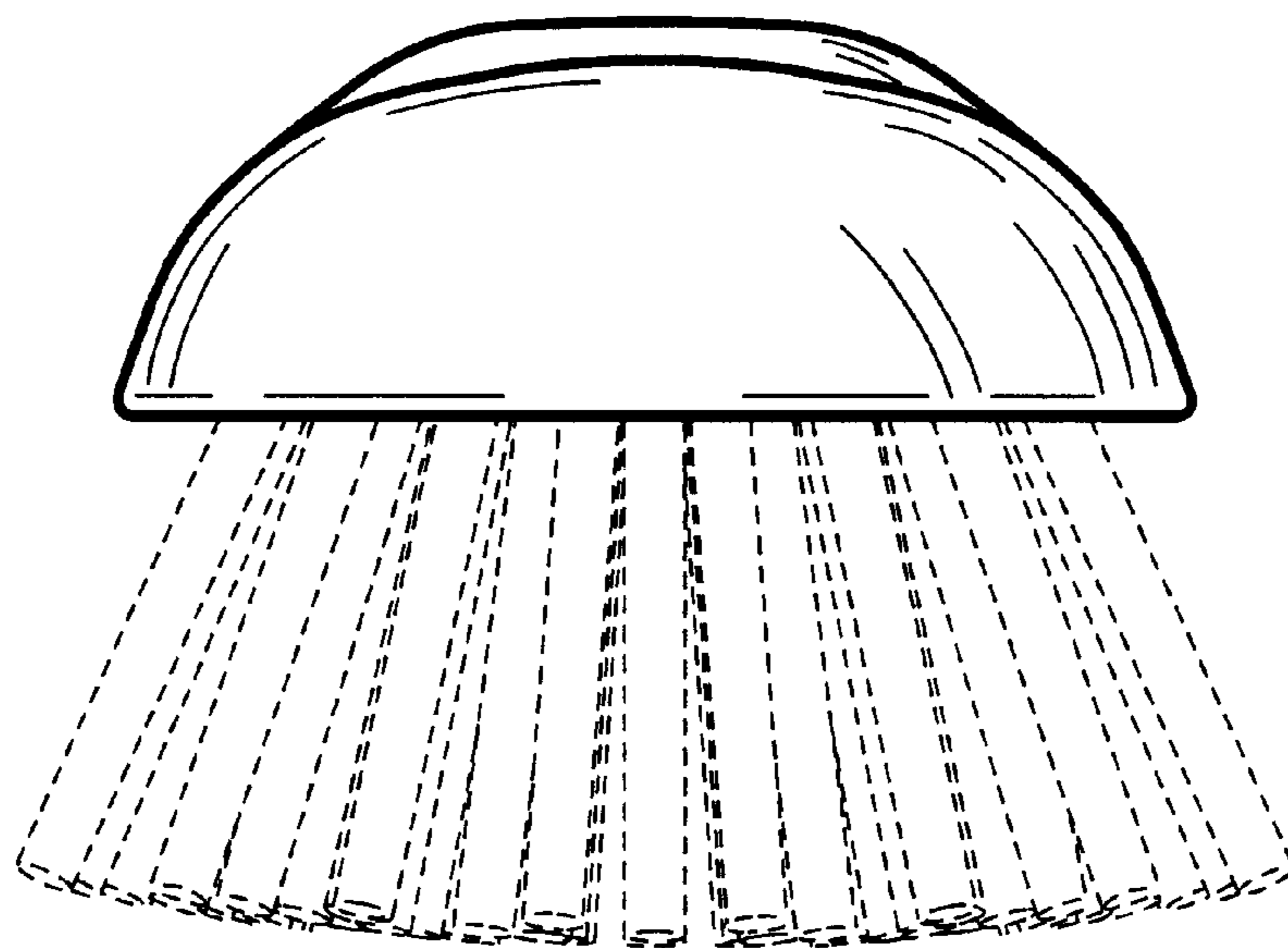

FIG:7

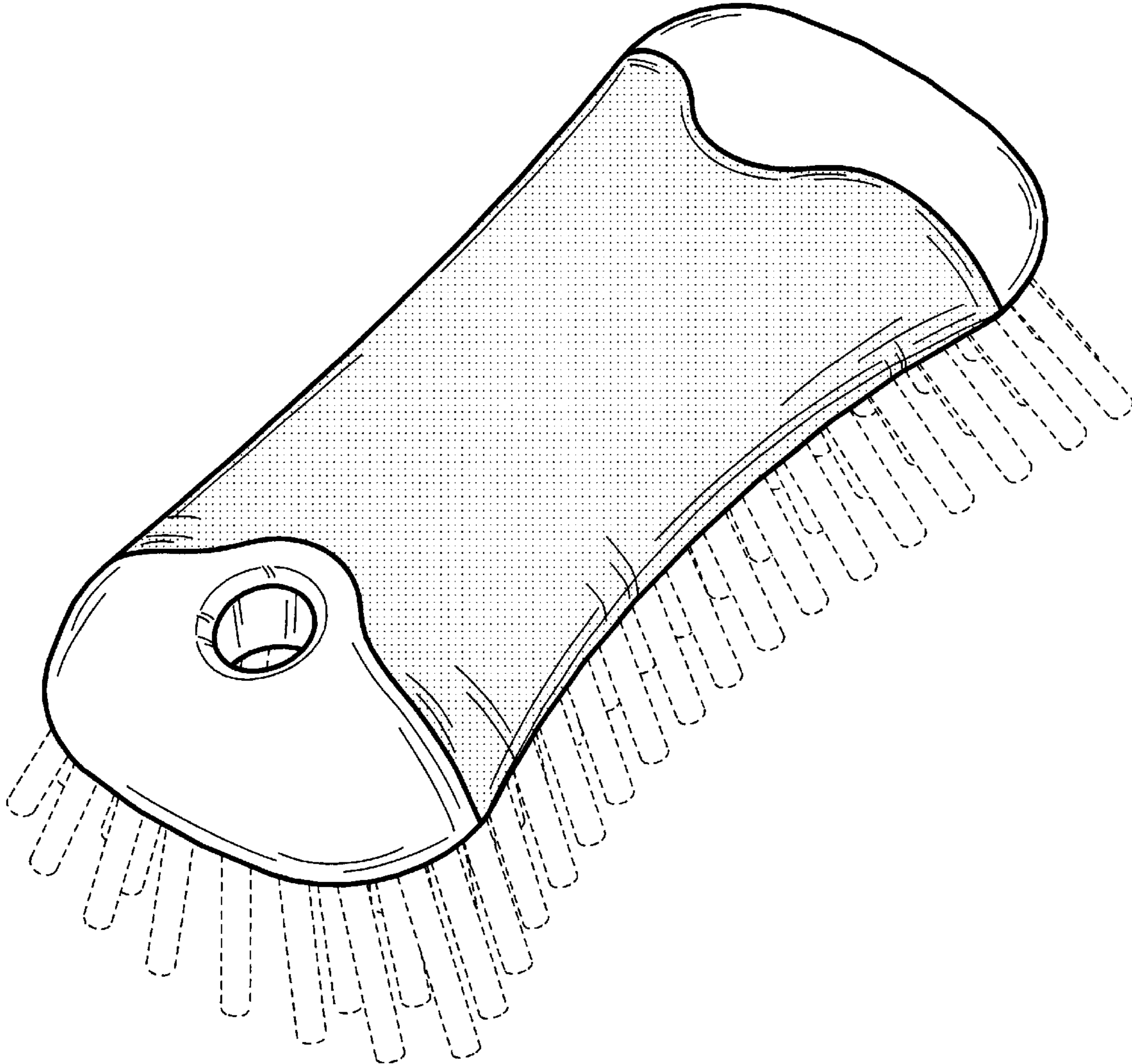

FIG:8

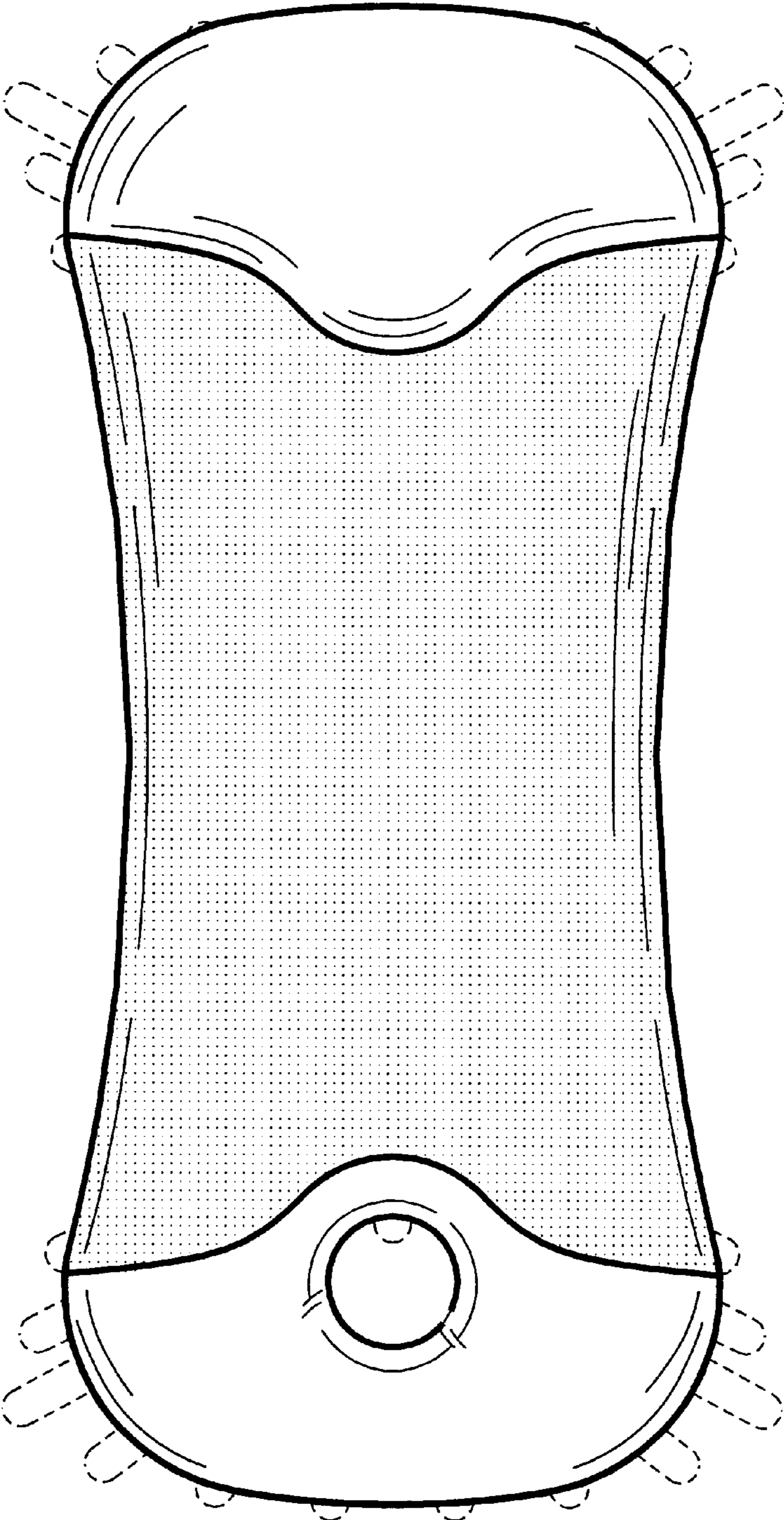

FIG:9

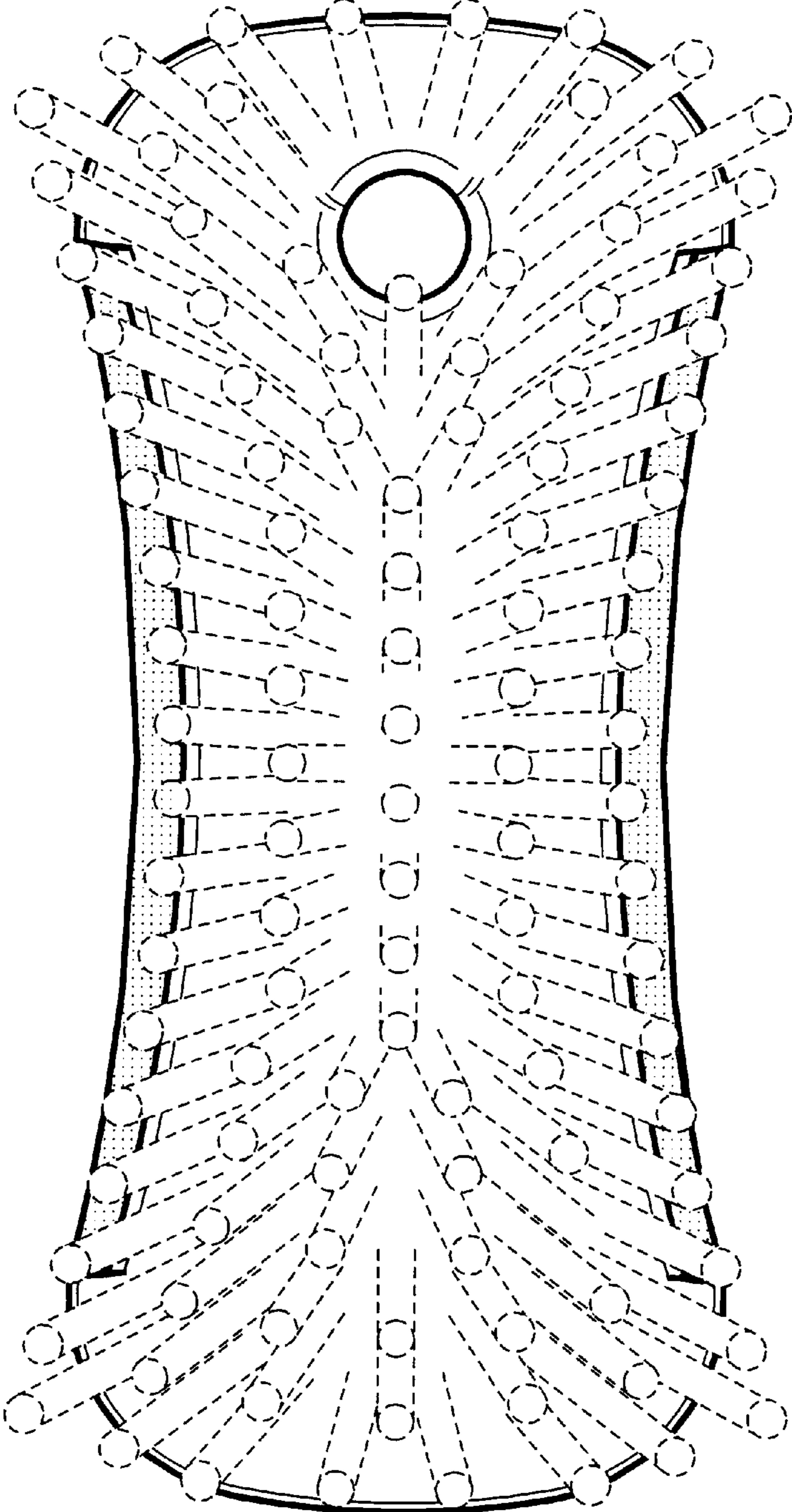

FIG:10

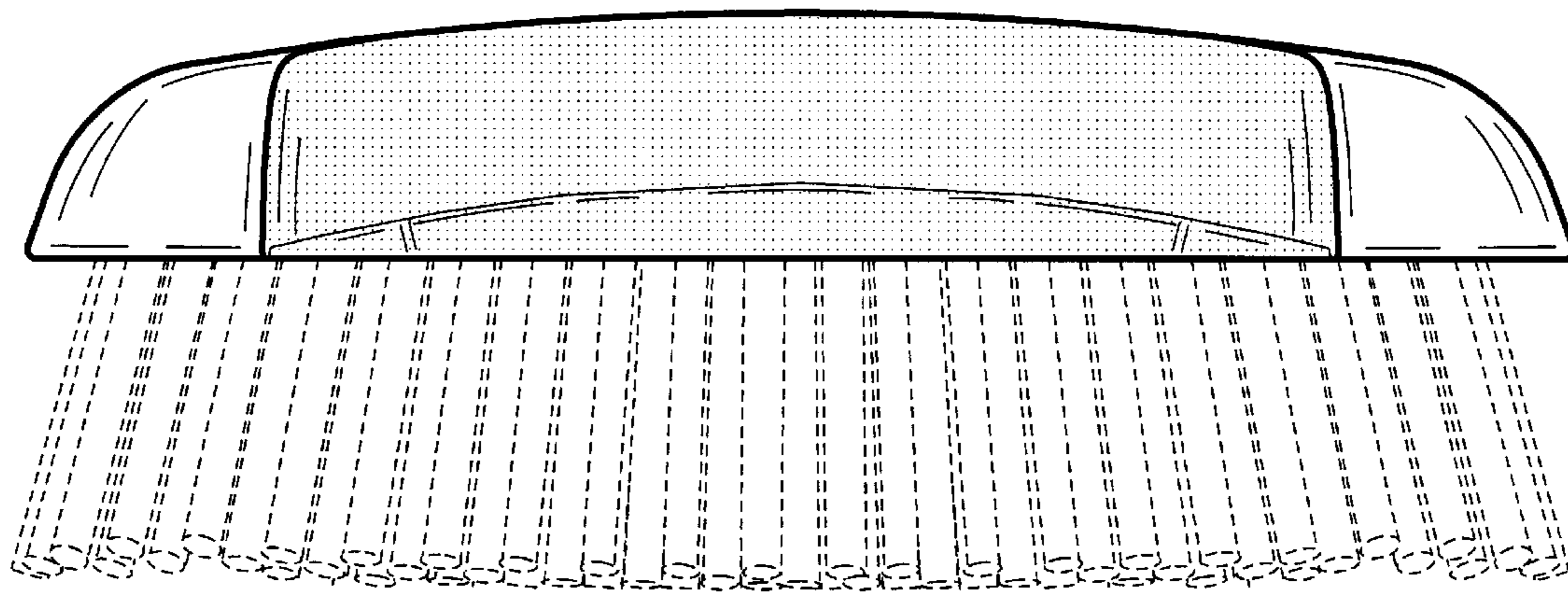

FIG:11

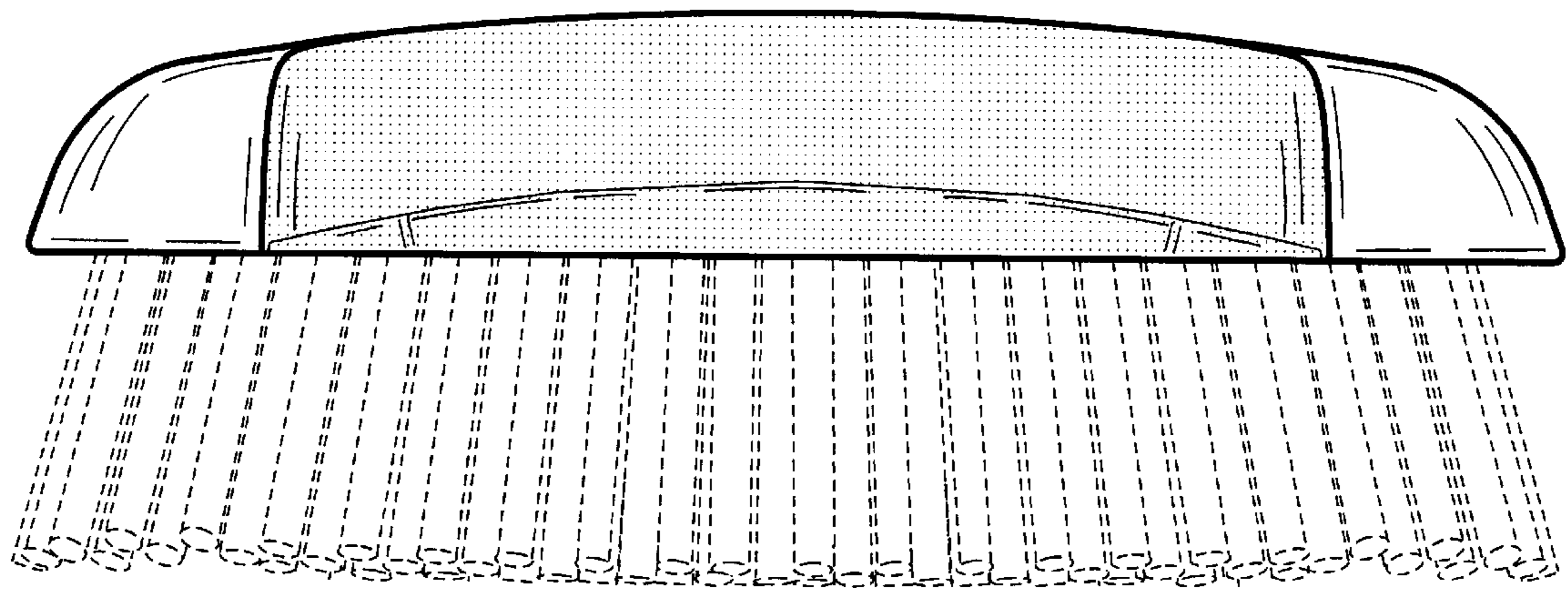

FIG:12

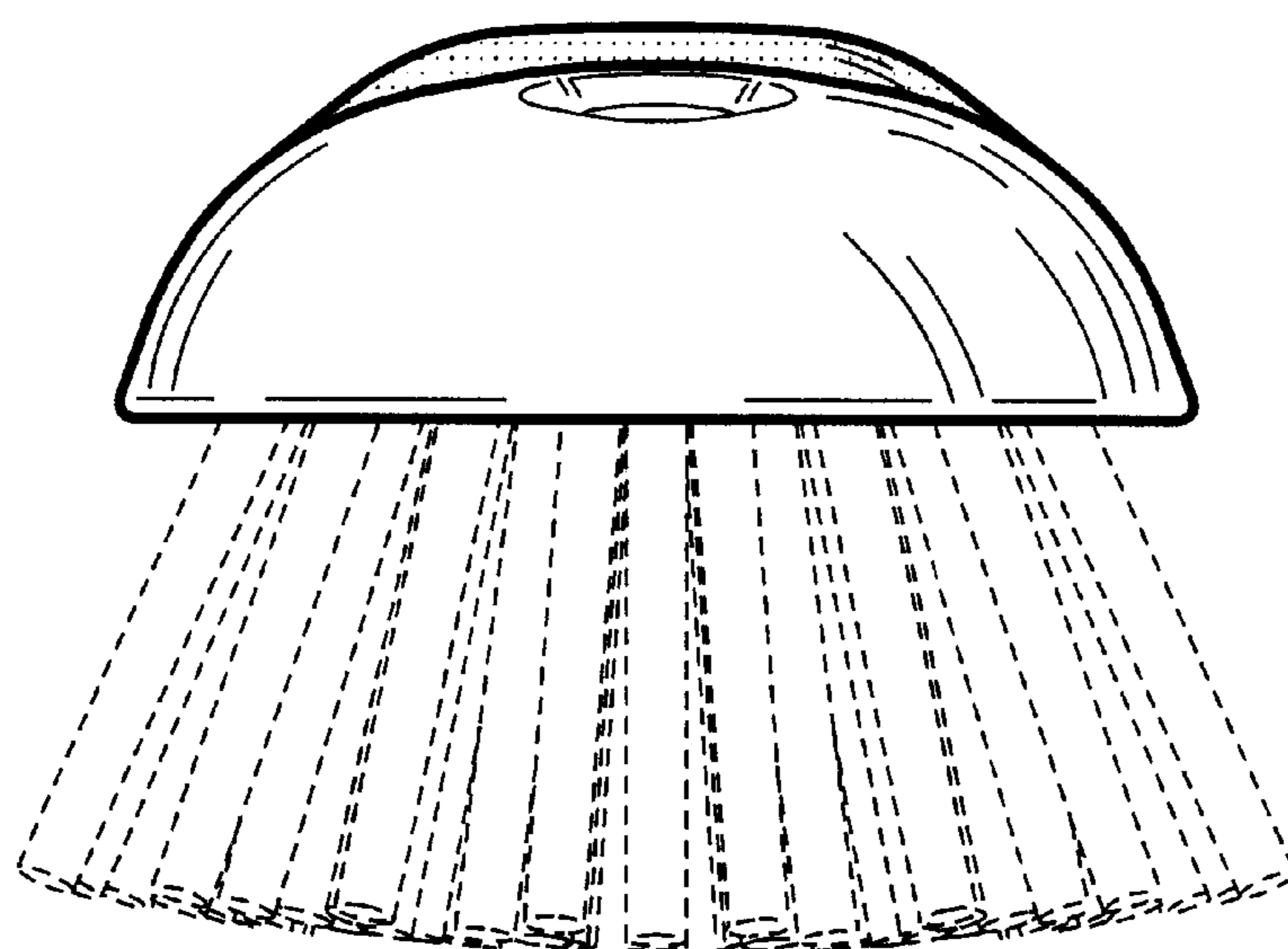

FIG:13

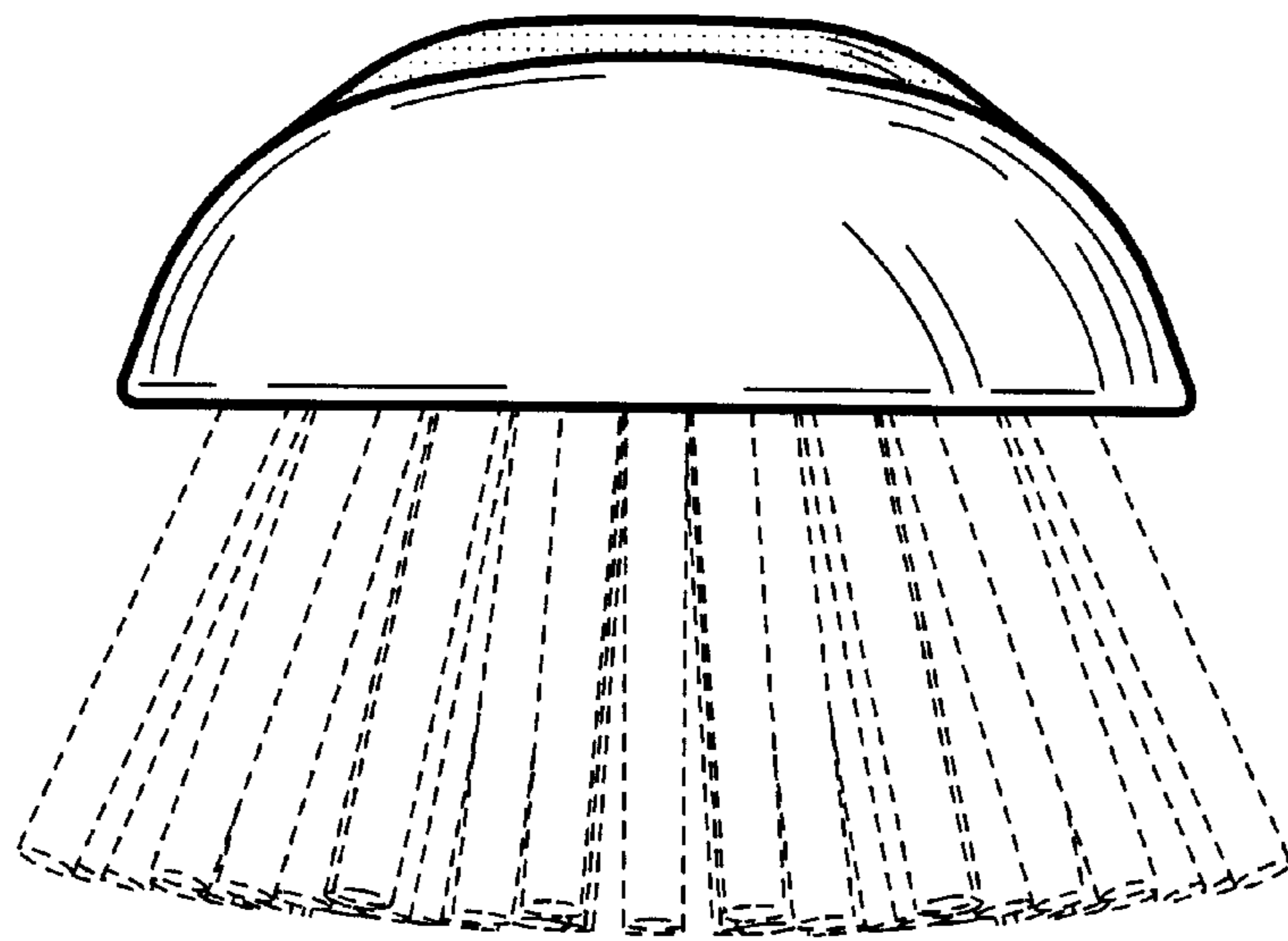

FIG:14