



US00D540009S

(12) **United States Design Patent**
Ceffalio

(10) **Patent No.:** **US D540,009 S**

(45) **Date of Patent:** **** Apr. 10, 2007**

(54) **MALE UNDERWEAR POCKET SUPPORT**

DESCRIPTION

(76) Inventor: **Christopher C. Ceffalio**, 8777 Harvest Valley Ave., Las Vegas, NV (US) 89129

(**) Term: **14 Years**

(21) Appl. No.: **29/218,192**

(22) Filed: **Nov. 29, 2004**

(51) **LOC (8) Cl.** **02-01**

(52) **U.S. Cl.** **D2/712**

(58) **Field of Classification Search** D2/700,
D2/701, 704, 712-714, 731, 737-738, 733;
2/67, 73, 78.1, 78.3, 400-402, 406-409,
2/403, 404, 405, 228, 238, 78.2, 78.4, 227
See application file for complete search history.

(56) **References Cited**

U.S. PATENT DOCUMENTS

2,183,431	A	*	12/1939	Powell	602/67
3,059,459	A	*	10/1962	Morgan	66/177
5,210,882	A	*	5/1993	Moretz et al.	2/404
5,297,296	A	*	3/1994	Moretz et al.	2/237
5,555,568	A	*	9/1996	Yon	2/403
D498,900	S	*	11/2004	Fox	D2/712
6,898,805	B1	*	5/2005	Truong et al.	2/400
6,901,607	B1	*	6/2005	Elwell	2/403
2006/0000008	A1	*	1/2006	Chong	2/403

* cited by examiner

Primary Examiner—Louis S. Zarfaz

Assistant Examiner—Kathleen Sims

(74) *Attorney, Agent, or Firm*—David Landman

(57) **CLAIM**

The ornamental design for a male underwear pocket support, as shown and described.

FIG. 1 is a front perspective view showing an outer front side of the male underwear pocket support with a portion of the outer front side of the male underwear pocket support having an opening.

FIG. 2 is a side perspective view showing one outer side of the male underwear pocket support of FIG. 1 with a portion of the outer front side of the male underwear pocket support having the opening.

FIG. 3 is a front inside-out perspective view showing an inner front side of the male underwear pocket support of FIG. 1 with the male underwear pocket support of FIG. 1 being turned inside out, a portion of the inner front side of the male underwear pocket support having another opening contiguous with the opening of the outer front side (see FIG. 1), and a portion of the inner front side of the male underwear pocket support comprising a first member adjacent to a portion of a back side of a second member defining a pocket of the male underwear pocket support of FIG. 1.

FIG. 4 is a top perspective view showing an inner portion of the male underwear pocket support of FIG. 1 with the inner front side of the male underwear pocket support comprising the first member adjacent to a portion of the back side of the second member defining the pocket with a lower inner portion of the male underwear pocket support having a pair of openings.

FIG. 5 is a bottom perspective view showing an outer bottom side of the male underwear pocket support of FIG. 1, having the pair of openings of FIG. 4 of the male underwear pocket support; and,

FIG. 6 is a back perspective view showing an outer back side of the male underwear pocket support of FIG. 1.

1 Claim, 6 Drawing Sheets

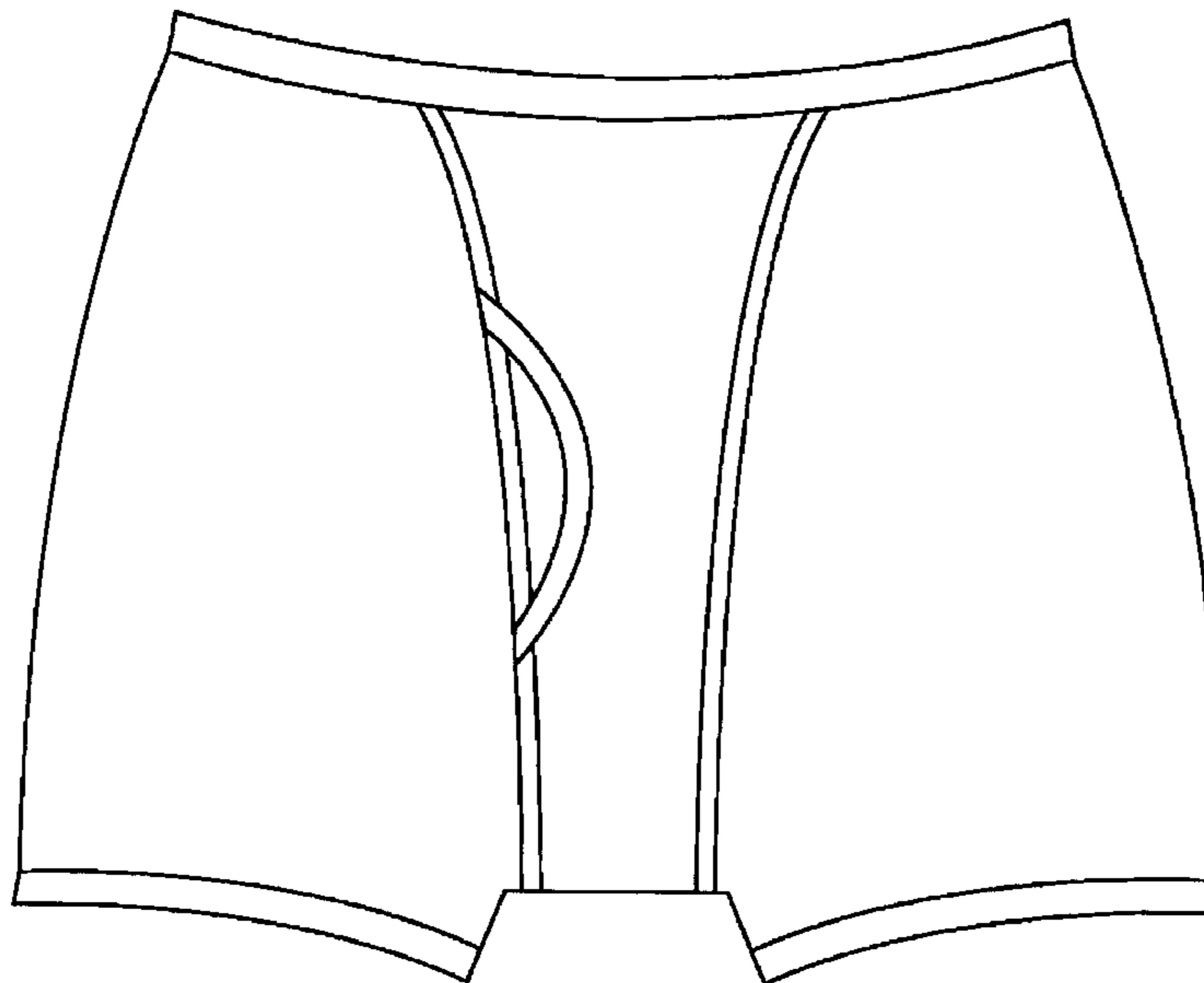

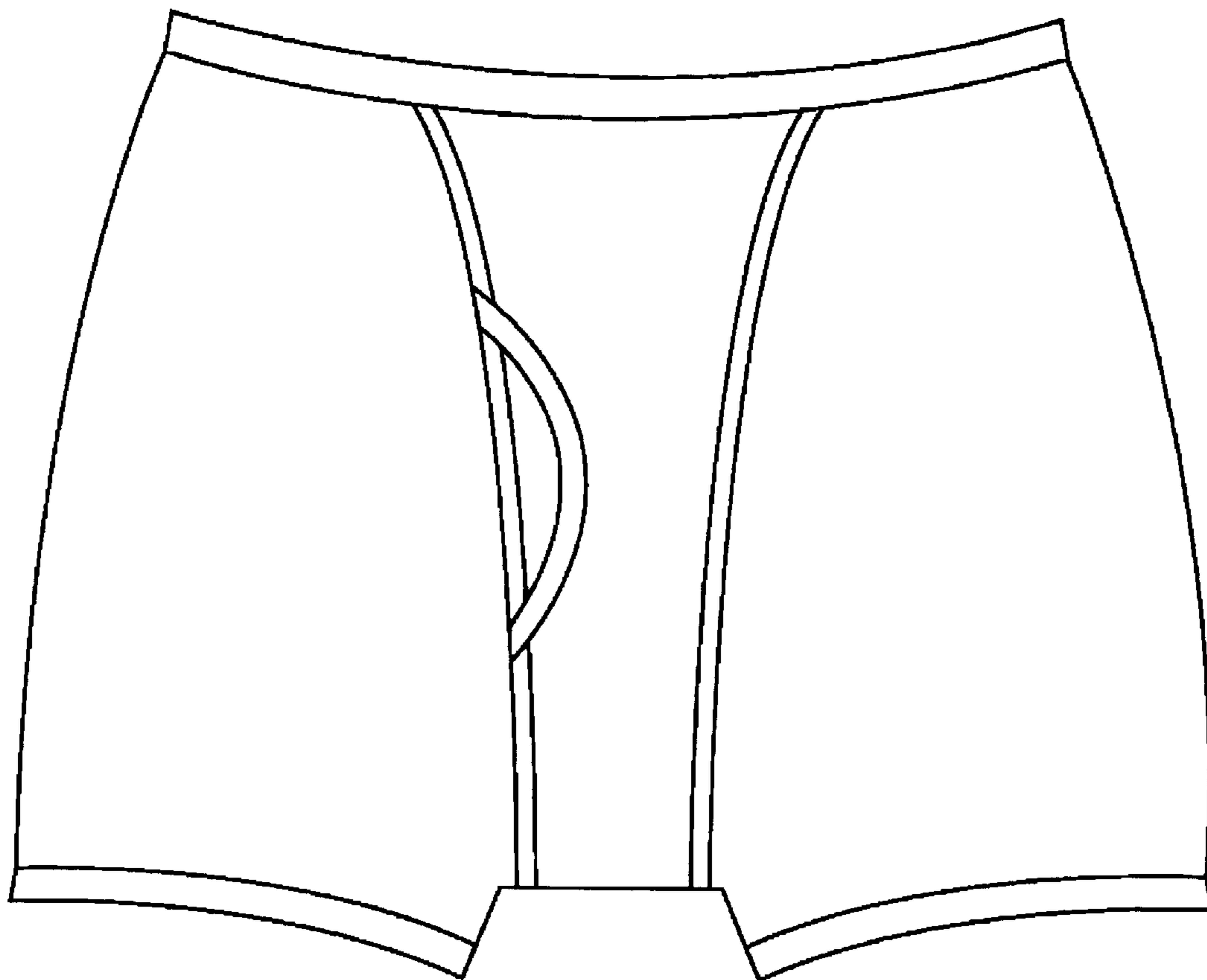

FIG. 1

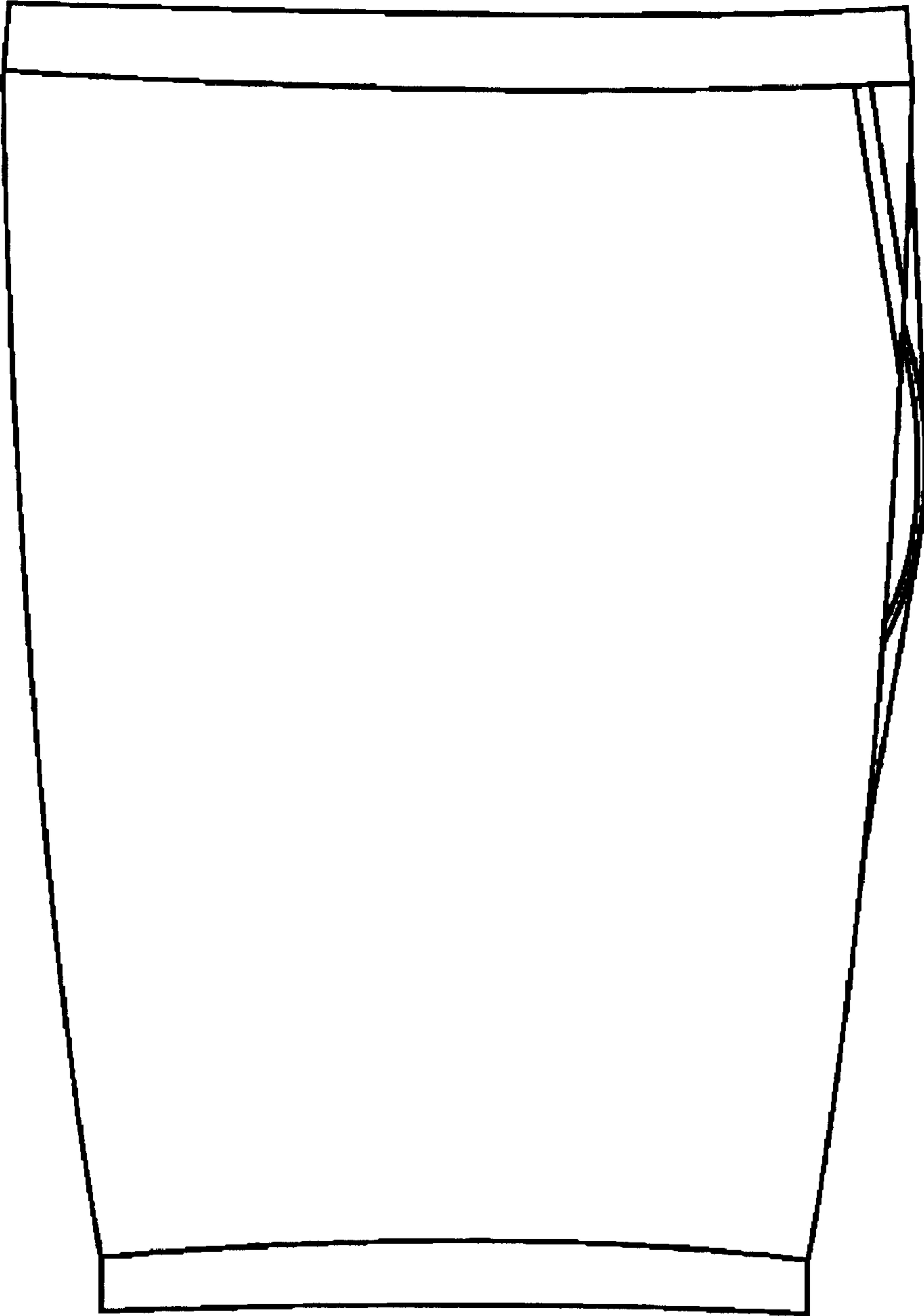

FIG. 2

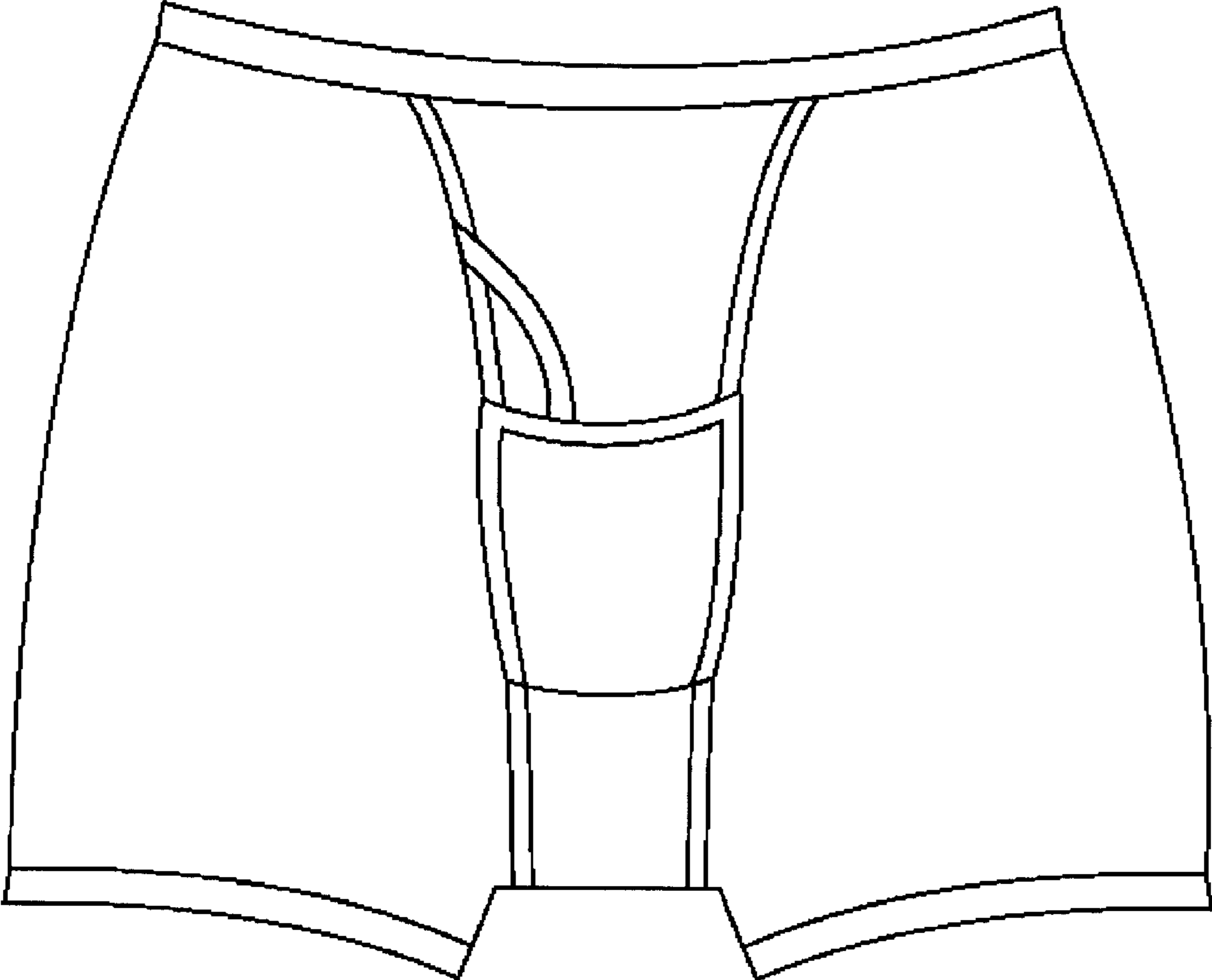

FIG. 3

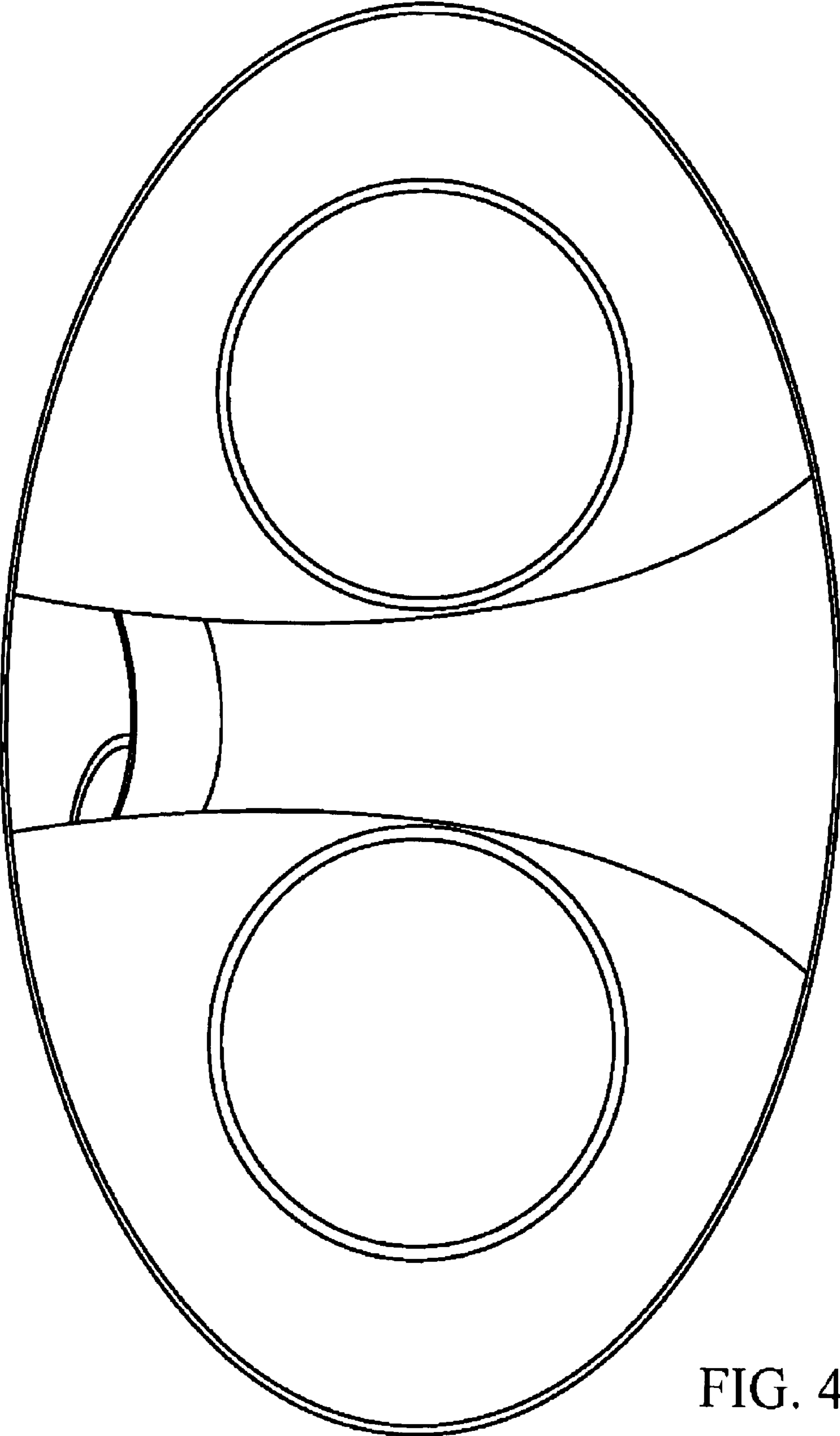

FIG. 4

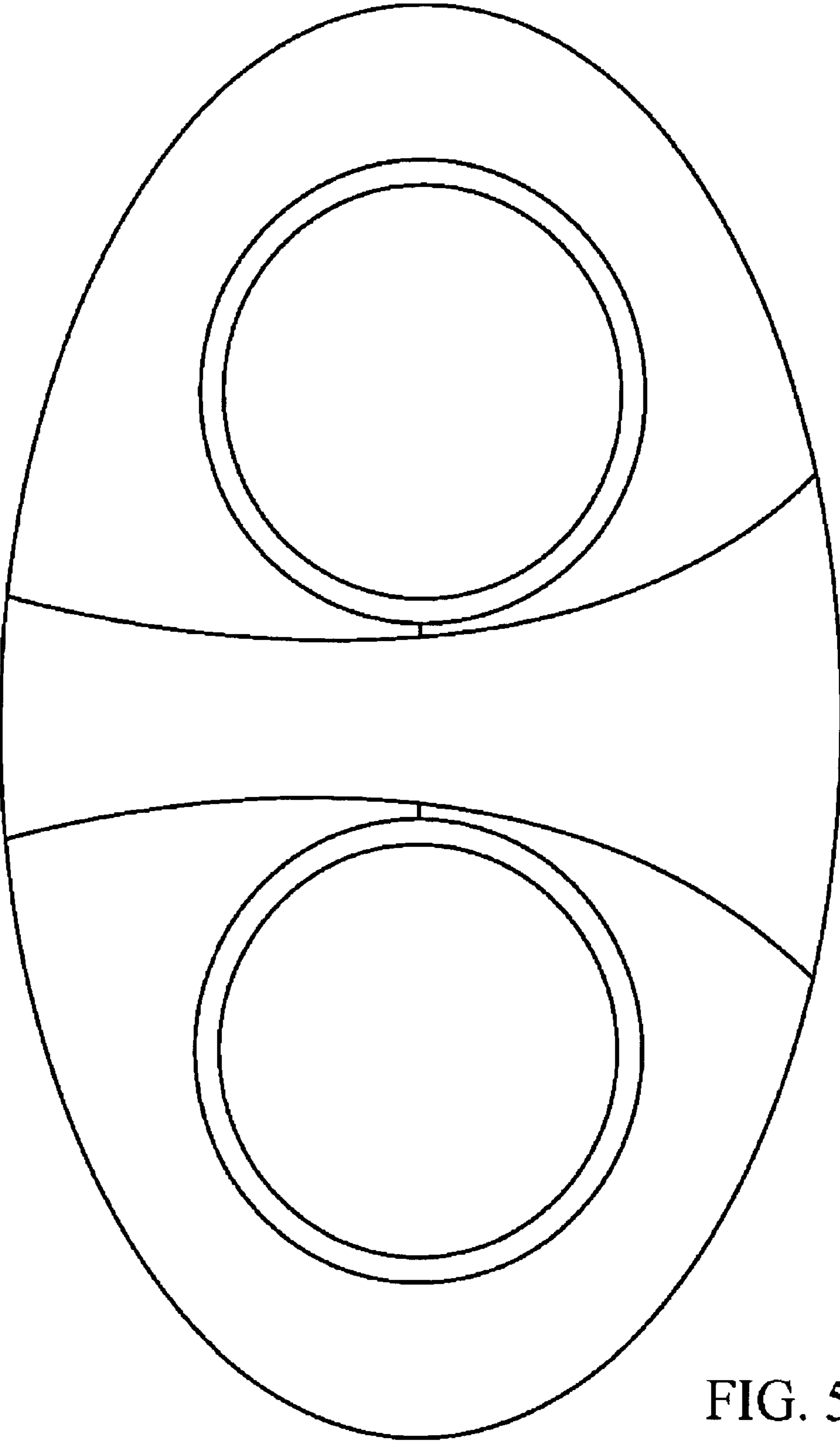

FIG. 5

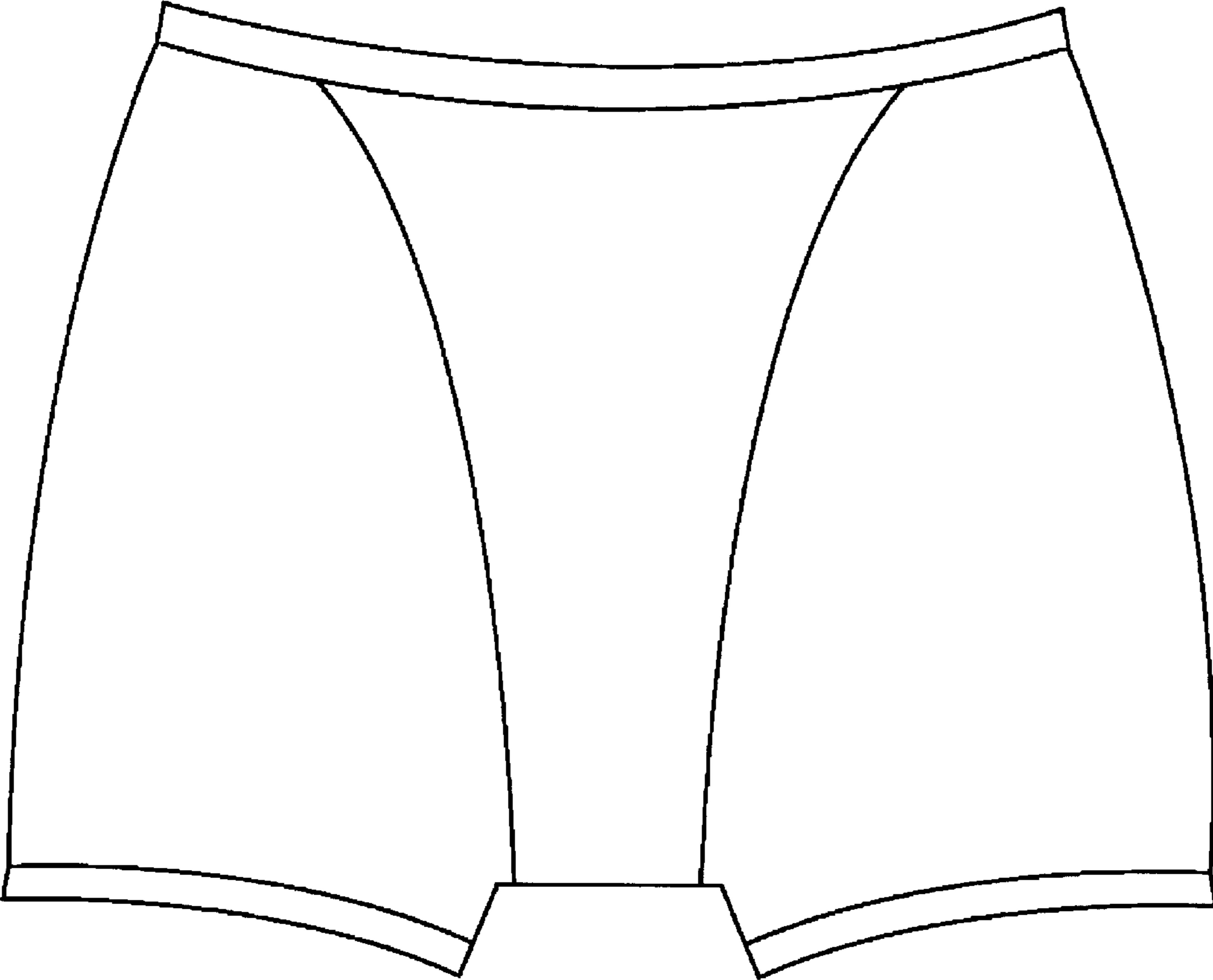

FIG. 6