



US00D539963S

(12) **United States Design Patent**
Hsu

(10) **Patent No.:** **US D539,963 S**

(45) **Date of Patent:** **** Apr. 3, 2007**

(54) **PENDENT LAMP**

(75) Inventor: **Kevin Hsu**, Taichung (TW)

(73) Assignee: **Dong Guan Bright Yinhuey Lighting Co., Ltd. China**, Guang Dong (CN)

(**) Term: **14 Years**

(21) Appl. No.: **29/259,146**

(22) Filed: **May 2, 2006**

(51) **LOC (8) Cl.** **26-03**

(52) **U.S. Cl.** **D26/88; D26/90**

(58) **Field of Classification Search** D26/72,
D26/80, 81-92, 143, 144, 118, 128; 362/147,
362/351, 363, 404, 806

See application file for complete search history.

(56) **References Cited**

U.S. PATENT DOCUMENTS

- D69,971 S * 4/1926 Schlepp D26/88
- D73,723 S * 10/1927 Villaret D26/89
- D202,804 S * 11/1965 Bushcott D26/135
- D404,167 S * 1/1999 Dolan D26/88

- D435,136 S * 12/2000 Miranda D26/88
- D441,896 S * 5/2001 Hsu D26/85
- D483,896 S * 12/2003 Hsu D26/85
- D503,490 S * 3/2005 Curtin D26/89
- D503,992 S * 4/2005 Curtin D26/88

* cited by examiner

Primary Examiner—Clare E Heflin

(74) *Attorney, Agent, or Firm*—Alan D. Kamrath; Nikolai & Mersereau, P.A.

(57) **CLAIM**

The ornamental design for a pendent lamp, as shown and described.

DESCRIPTION

FIG. 1 is a perspective view of a pendent lamp showing my design;

FIG. 2 is a front elevational view thereof;

FIG. 3 is a rear elevational view thereof;

FIG. 4 is a left side elevational view thereof;

FIG. 5 is a right side elevational view thereof;

FIG. 6 is a top plan view thereof; and,

FIG. 7 is a bottom plan view thereof.

1 Claim, 7 Drawing Sheets

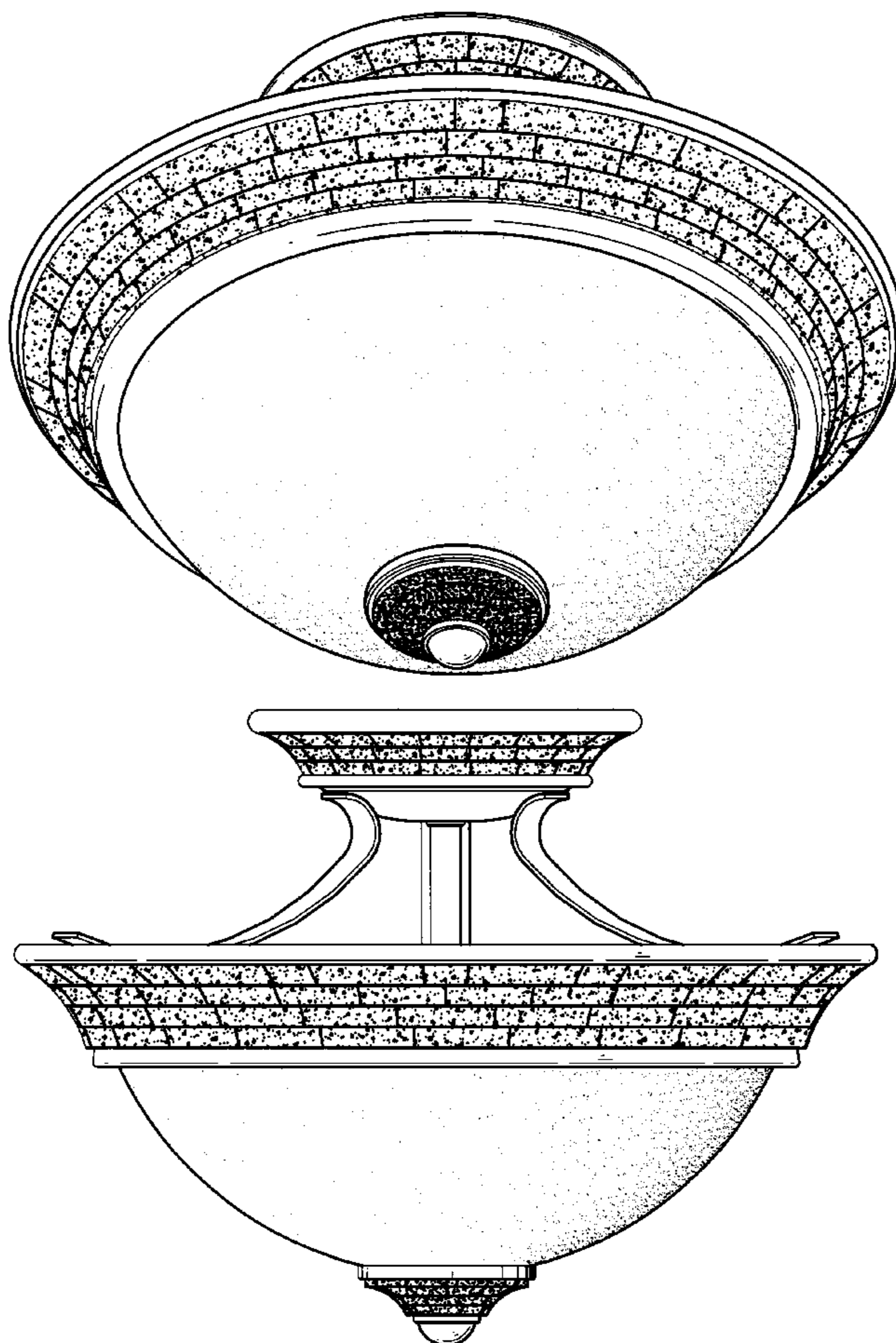

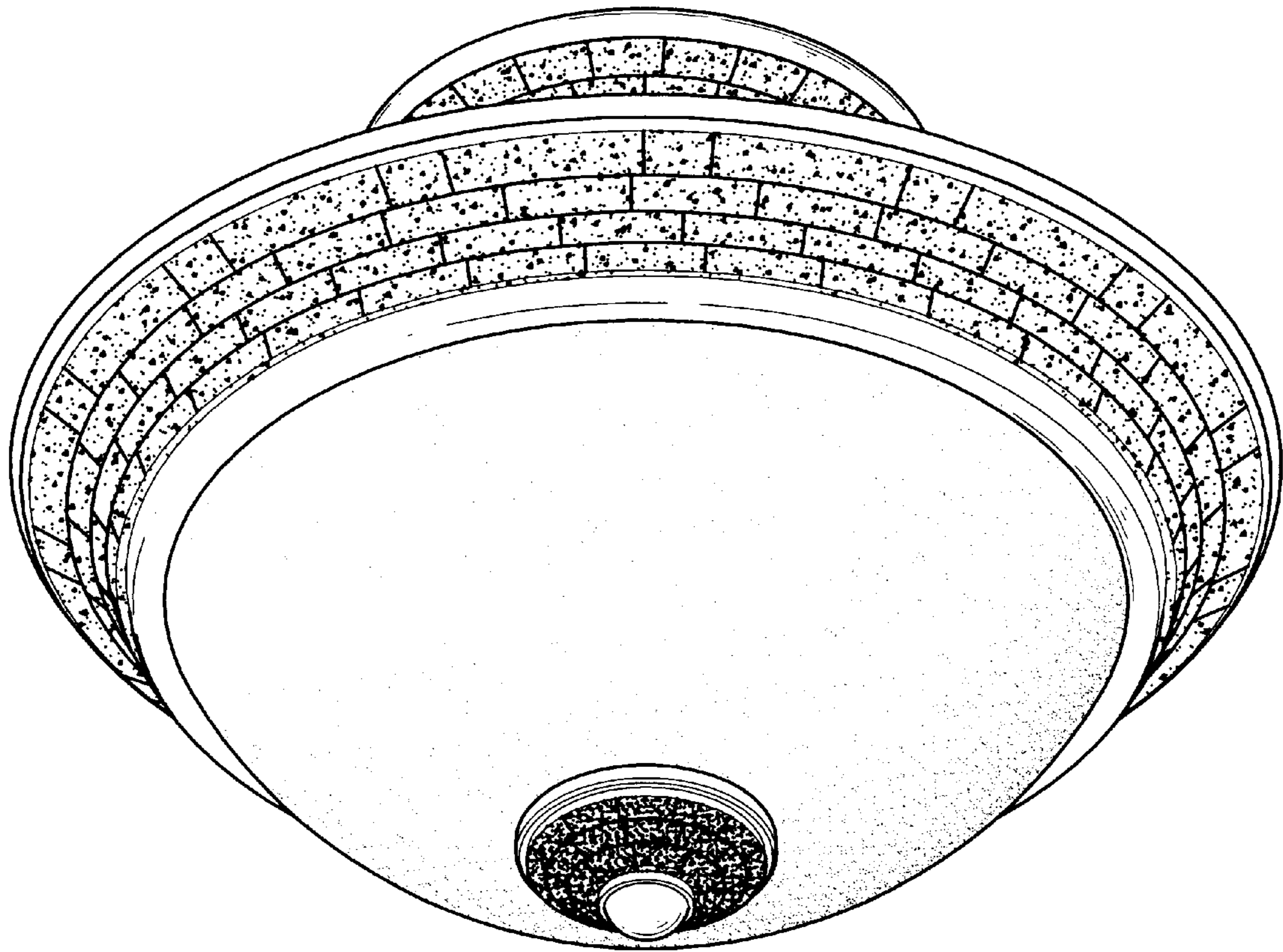

FIG. 1

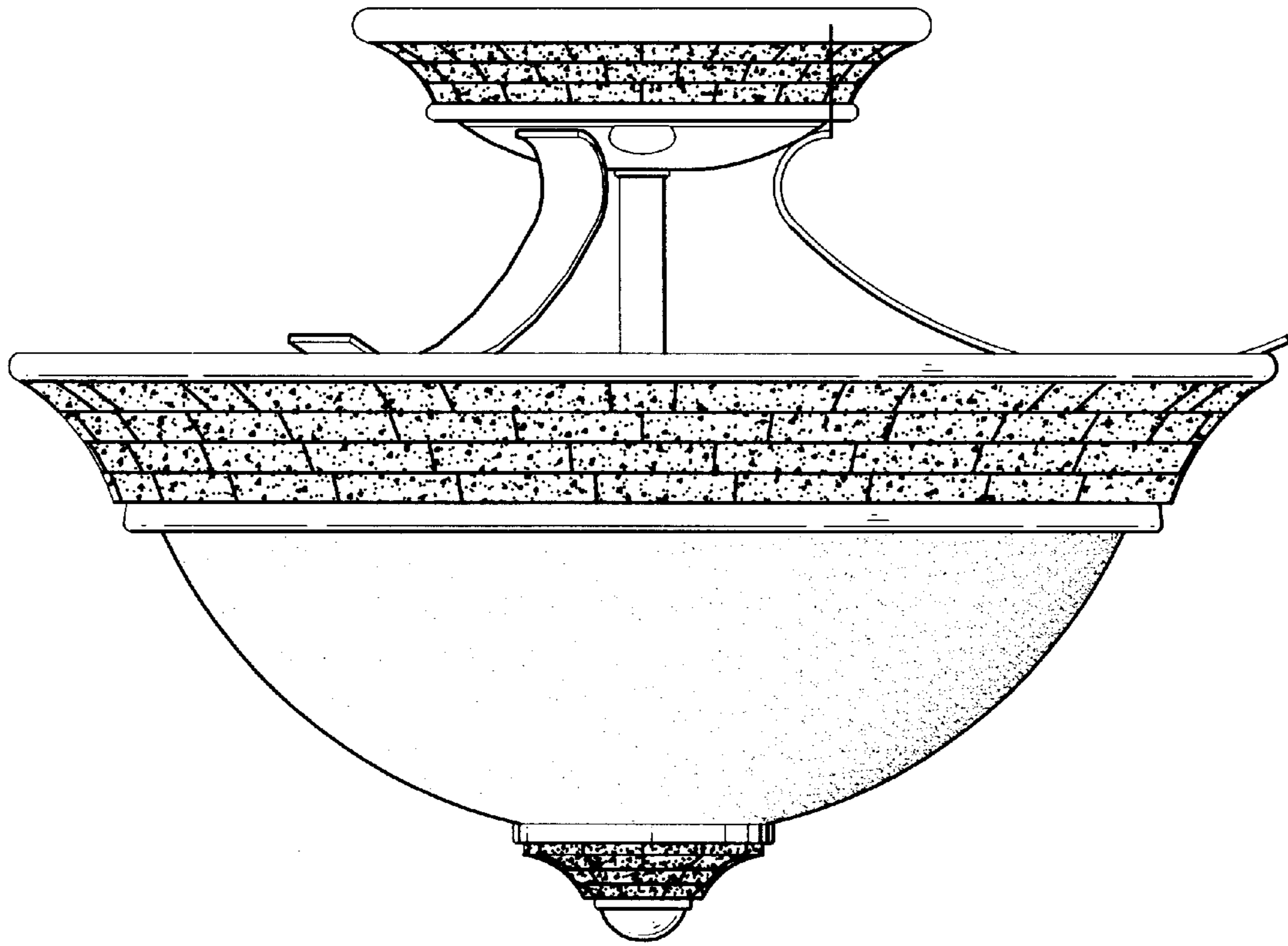

FIG. 2

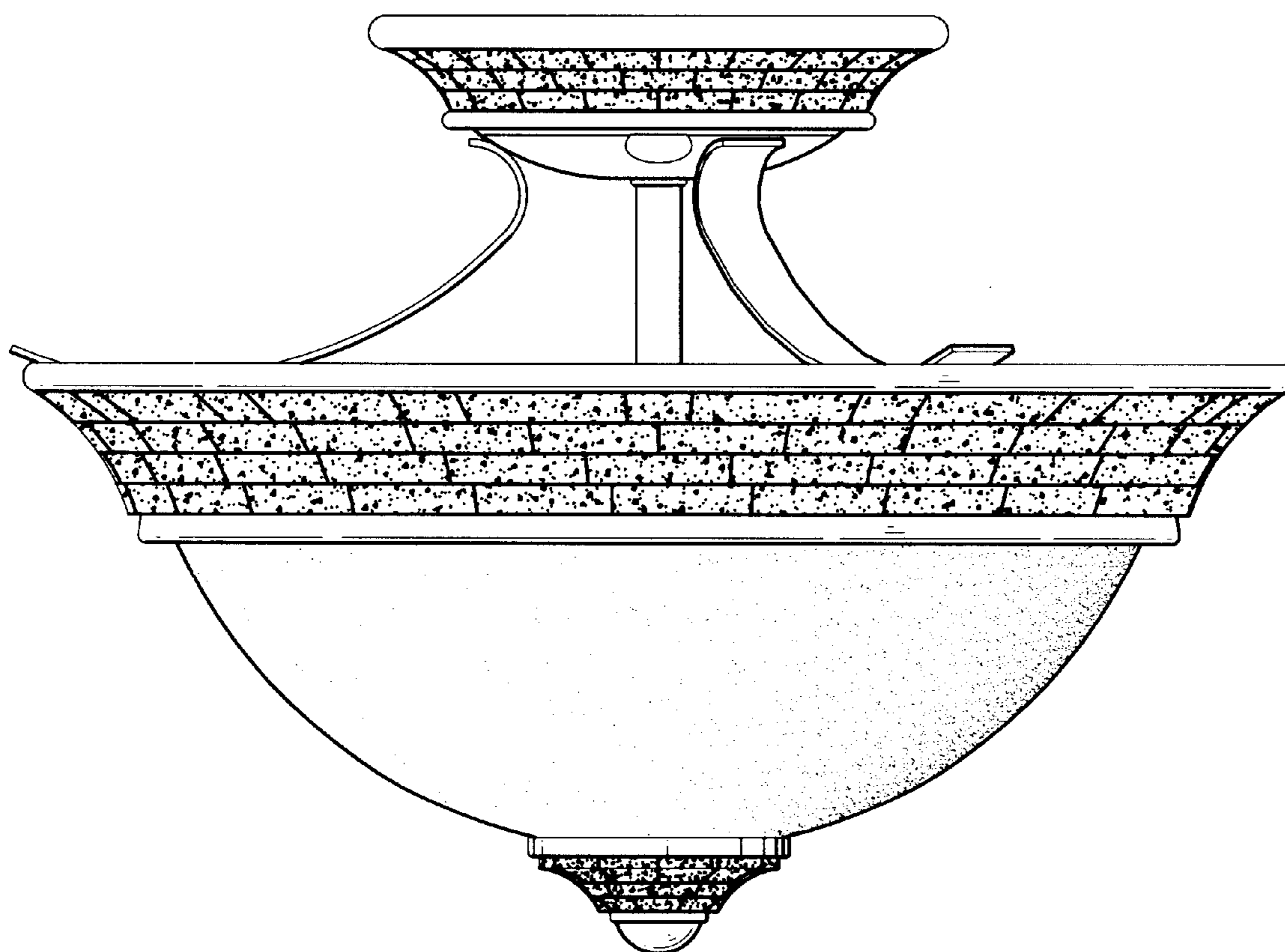

FIG. 3

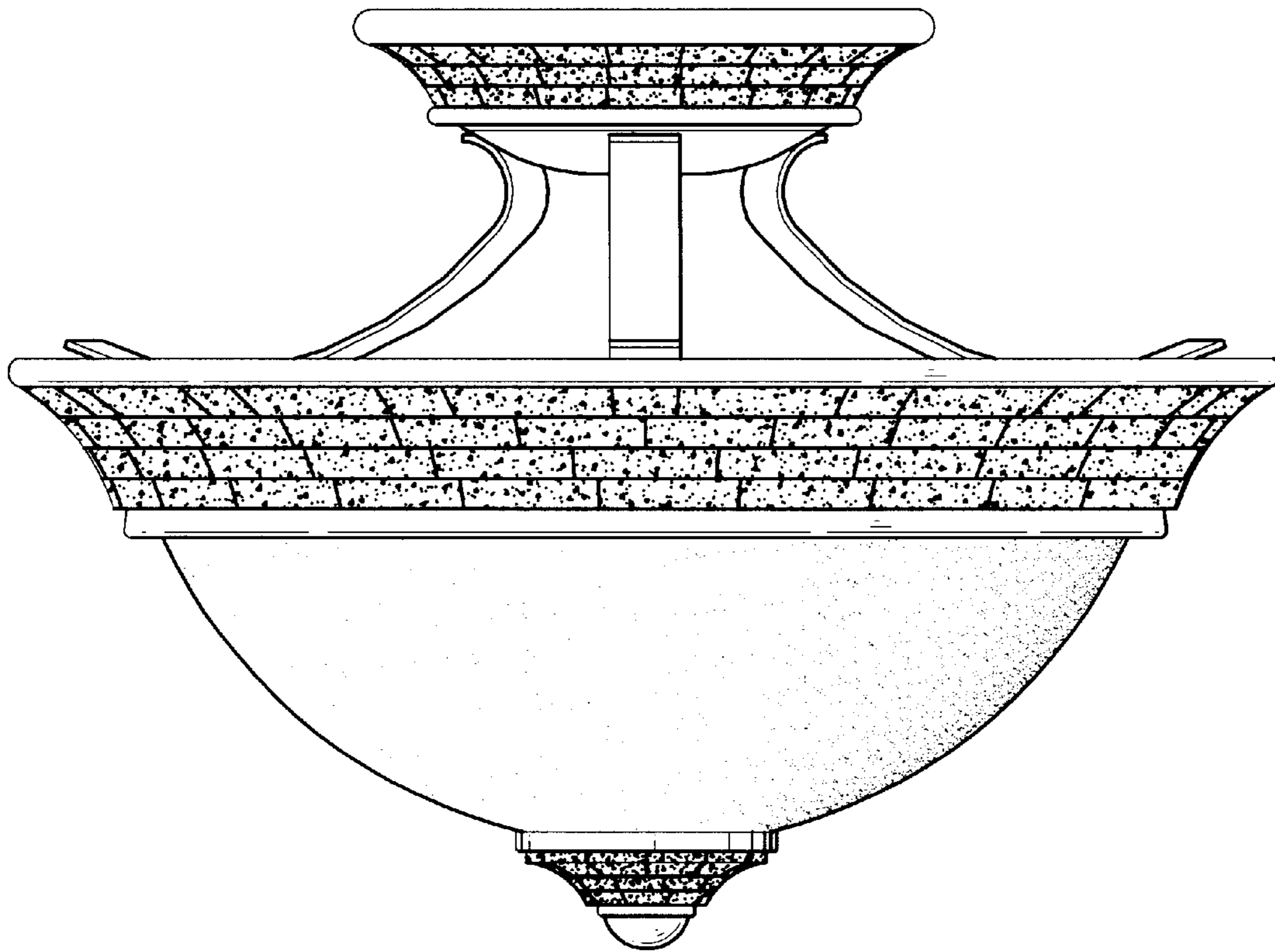

FIG. 4

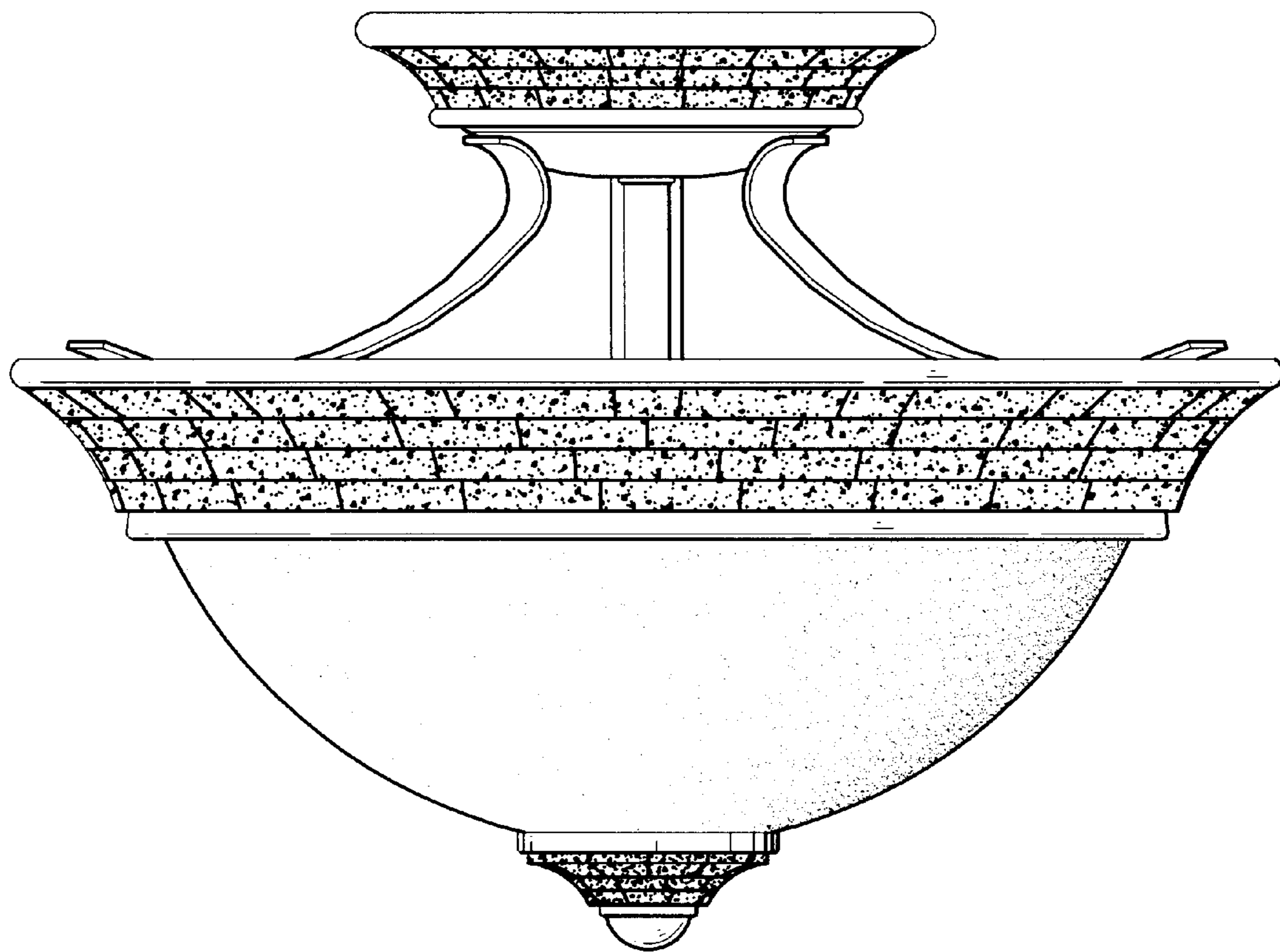

FIG. 5

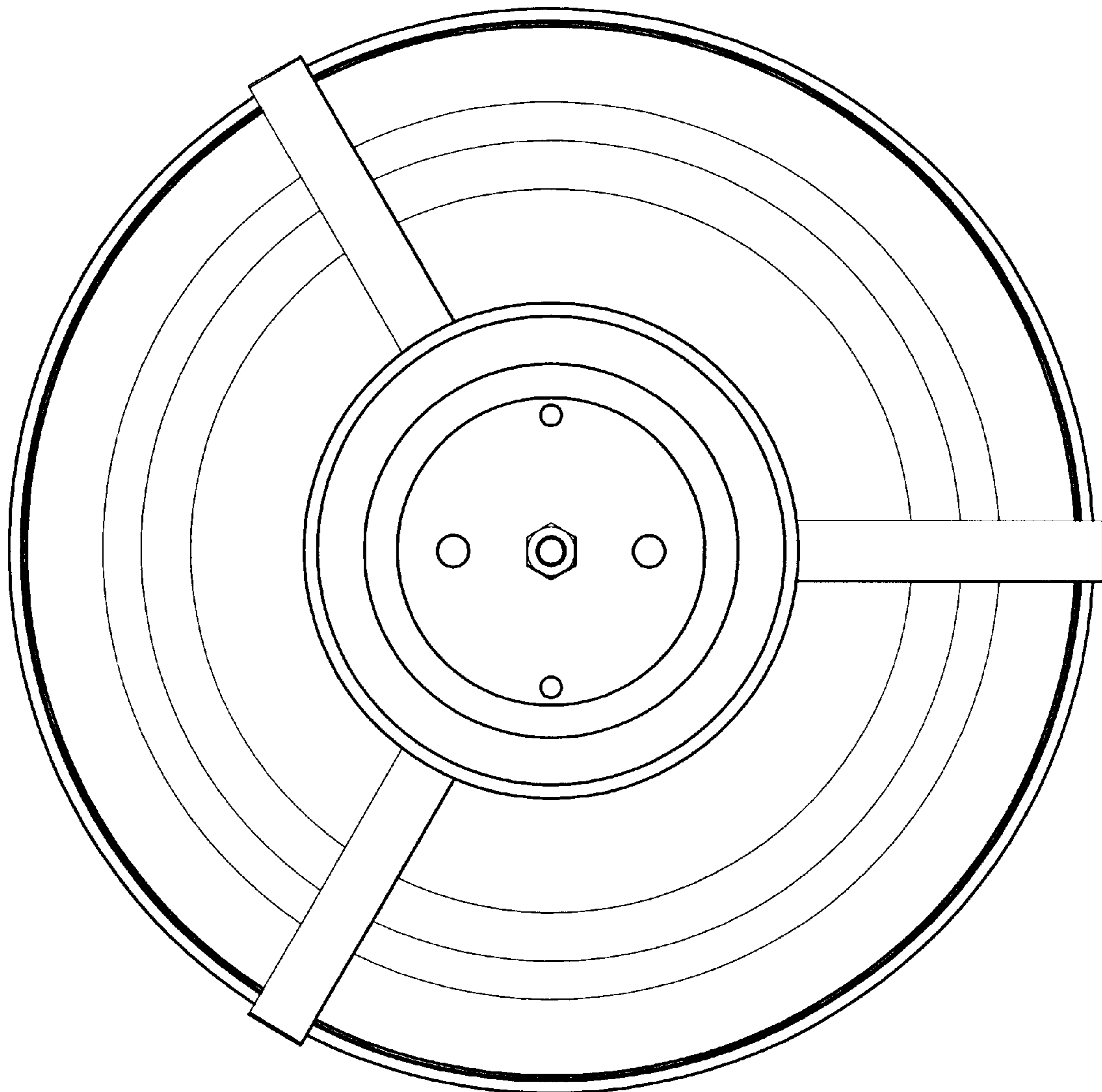

FIG. 6

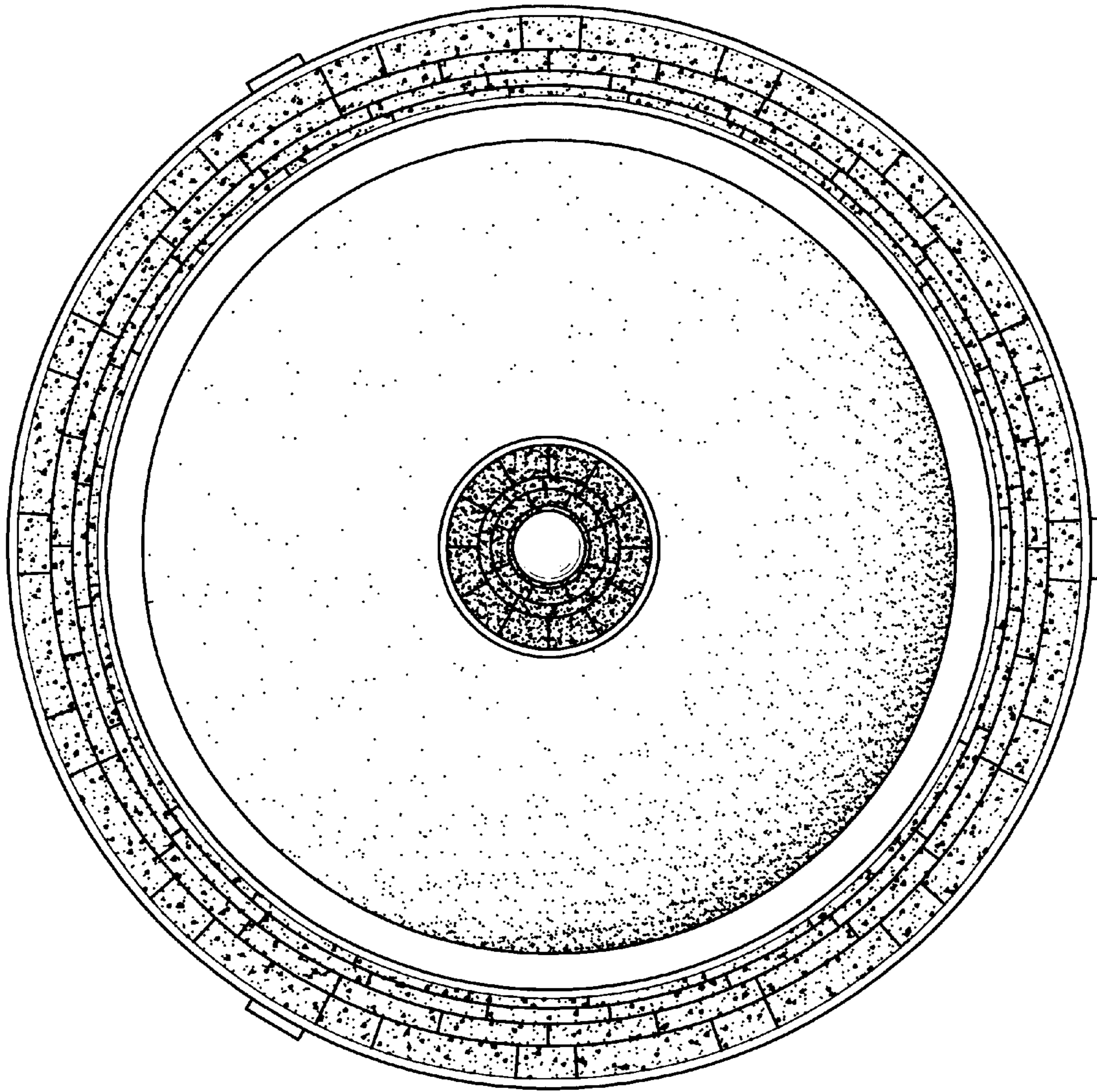

FIG. 7