



US00D539785S

(12) **United States Design Patent**
Zhang

(10) **Patent No.:** **US D539,785 S**

(45) **Date of Patent:** **** Apr. 3, 2007**

(54) **SPEAKER**

(75) Inventor: **Zhiming Zhang**, Zhejiang Province
(CN)

(73) Assignee: **Compupal (Group) Corporation** (CN)

(**) Term: **14 Years**

(21) Appl. No.: **29/221,626**

(22) Filed: **Jan. 21, 2005**

(30) **Foreign Application Priority Data**

Aug. 6, 2004 (CN) 2004300713082

(51) **LOC (8) Cl.** **14-01**

(52) **U.S. Cl.** **D14/215**

(58) **Field of Classification Search** D14/204,
D14/207, 210-216; 181/143-144, 147-148,
181/150, 157, 198-199, 151, 153; 381/300-302,
381/306, 333, 345, 361-364, 386-388, 332,
381/336

See application file for complete search history.

(56) **References Cited**

U.S. PATENT DOCUMENTS

4,334,211 A * 6/1982 McConnell et al. 181/198

4,450,495 A * 5/1984 Naruki 381/387
D319,446 S * 8/1991 Yamamoto D14/215
6,600,827 B2 * 7/2003 Lu 381/333
D498,471 S * 11/2004 Solland et al. D14/215

* cited by examiner

Primary Examiner—Nanda Bondade

(74) *Attorney, Agent, or Firm*—Banner & Witcoff, Ltd.

(57) **CLAIM**

The ornamental design for a speaker, as shown and described.

DESCRIPTION

FIG. 1 is a front view of a speaker showing my new design;
FIG. 2 is a rear view thereof;
FIG. 3 is a right side view thereof;
FIG. 4 is a left side view thereof;
FIG. 5 is a top plan view thereof;
FIG. 6 is a bottom view thereof;
FIG. 7 is the front view showing the speaker in a turning
position; and,
FIG. 8 is the right side view showing the speaker in a turning
position.

1 Claim, 3 Drawing Sheets

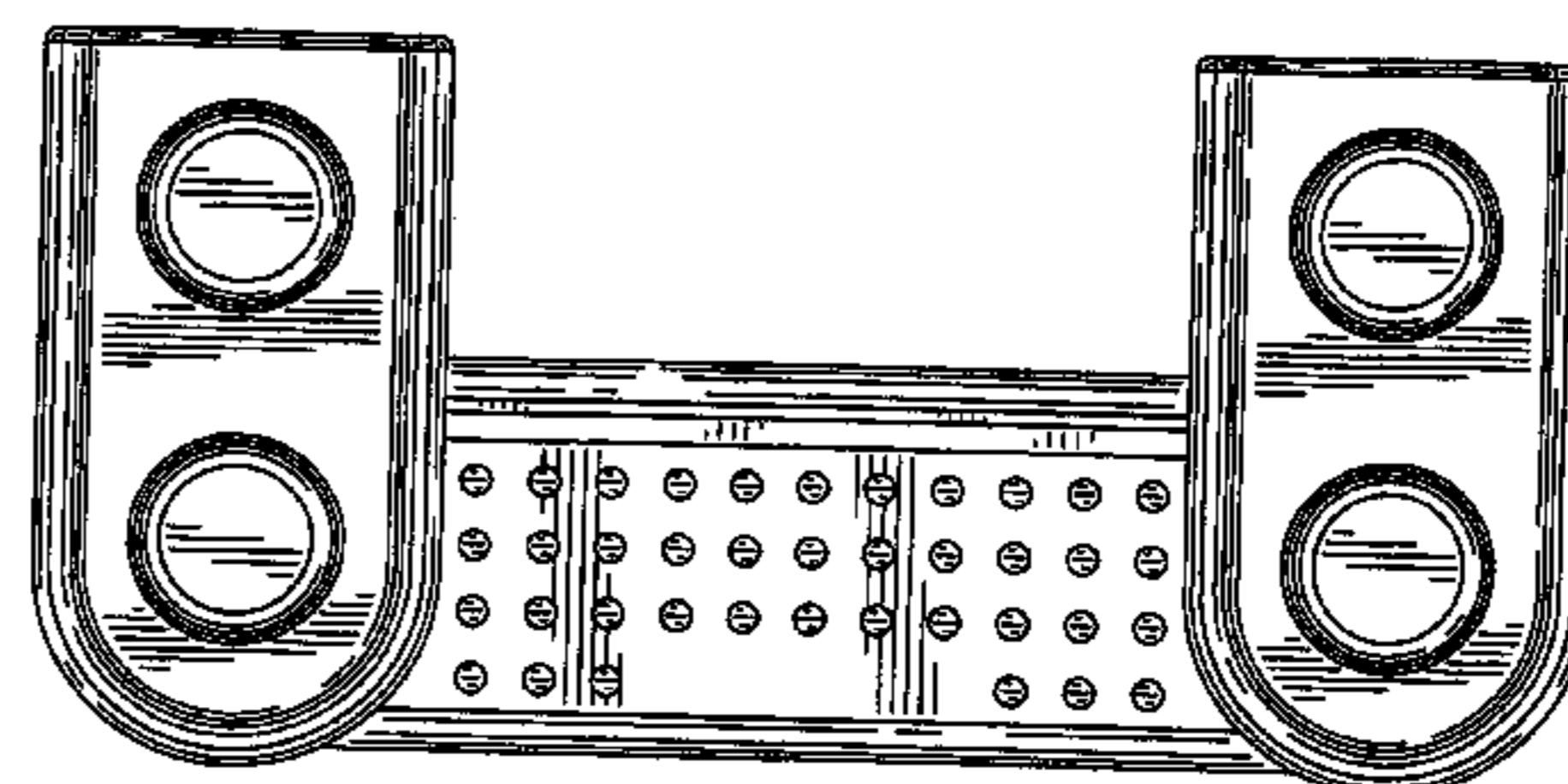
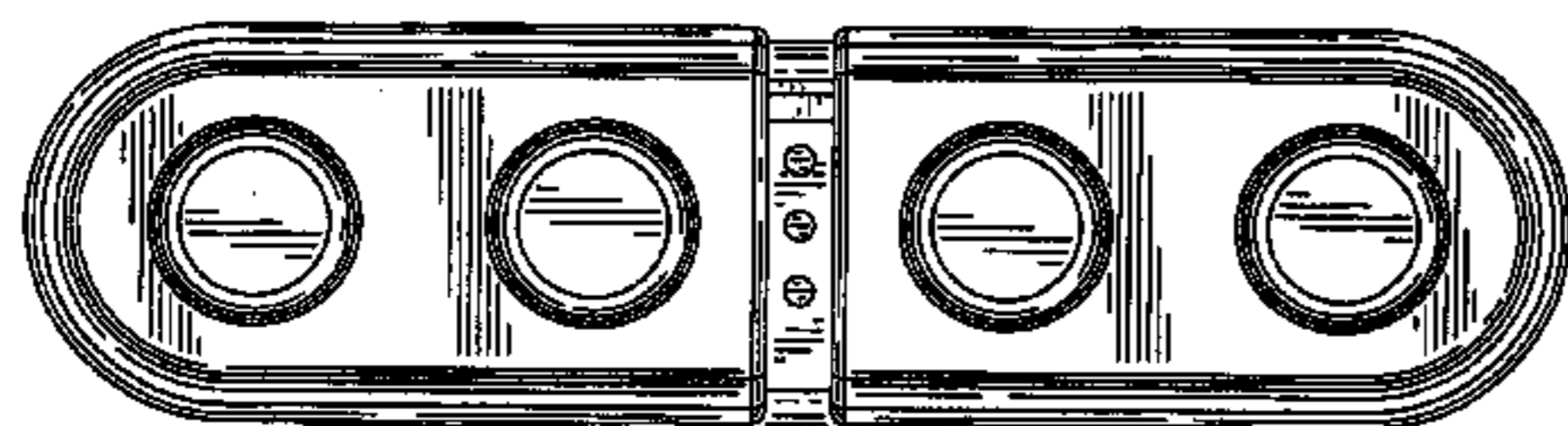

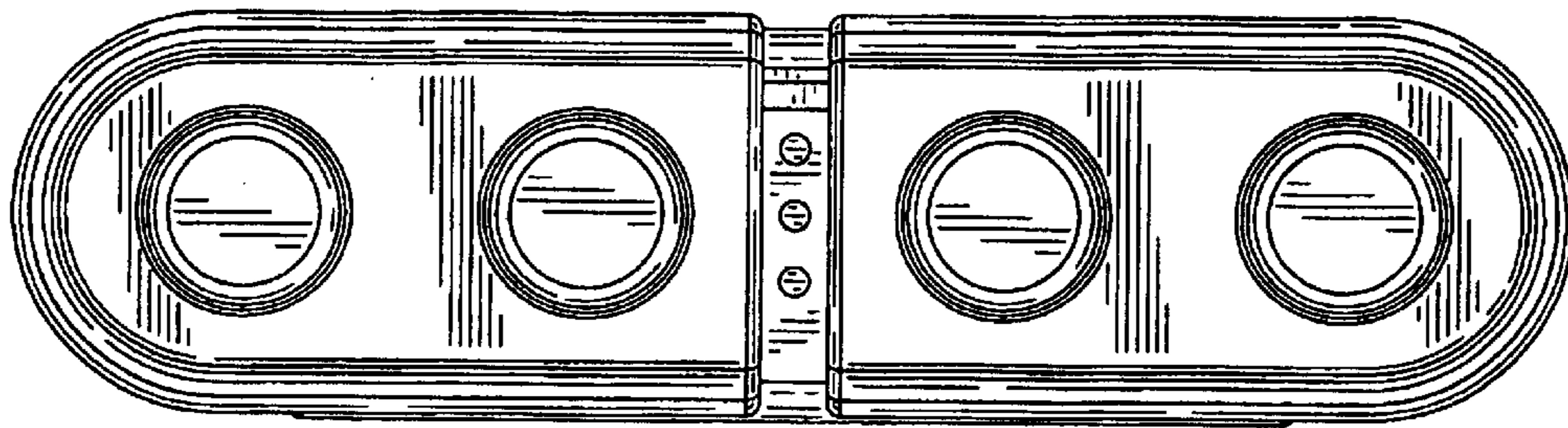

FIG. 1

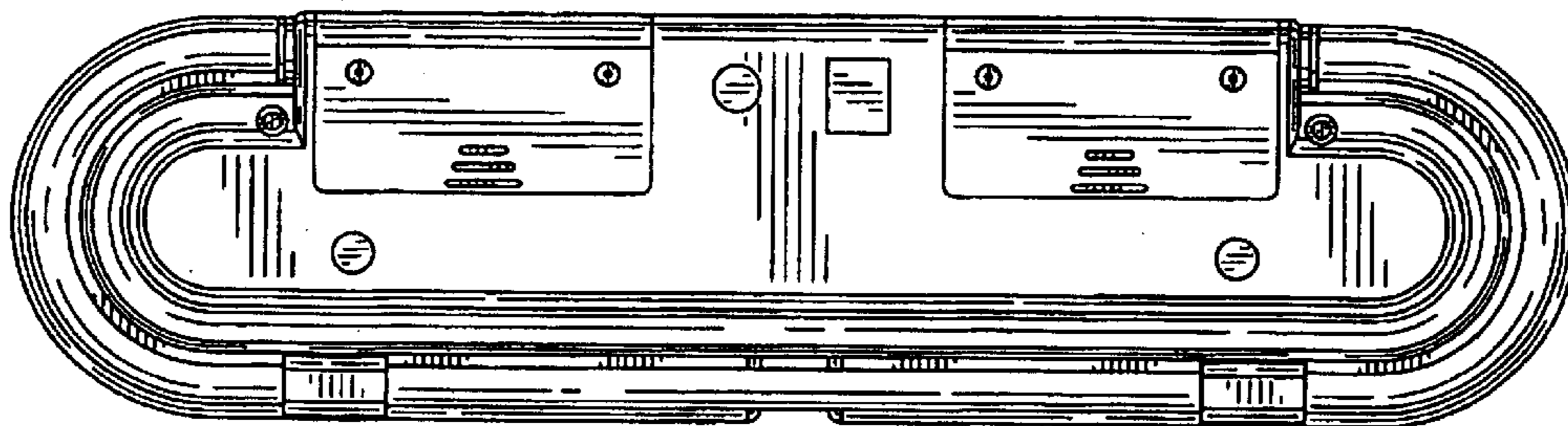

FIG. 2

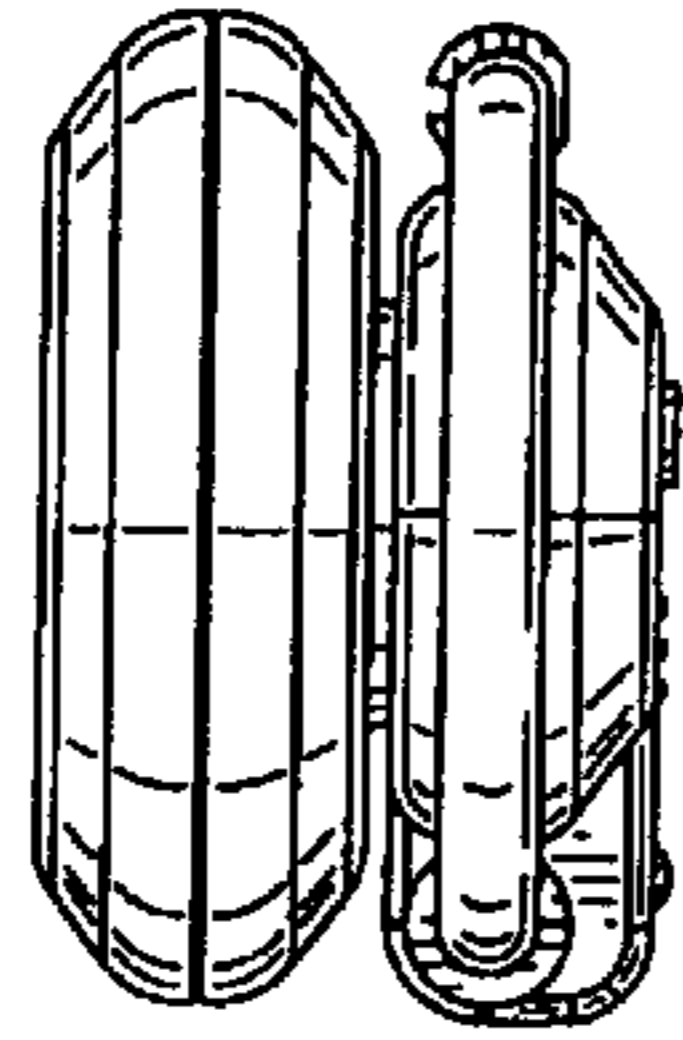

FIG. 3

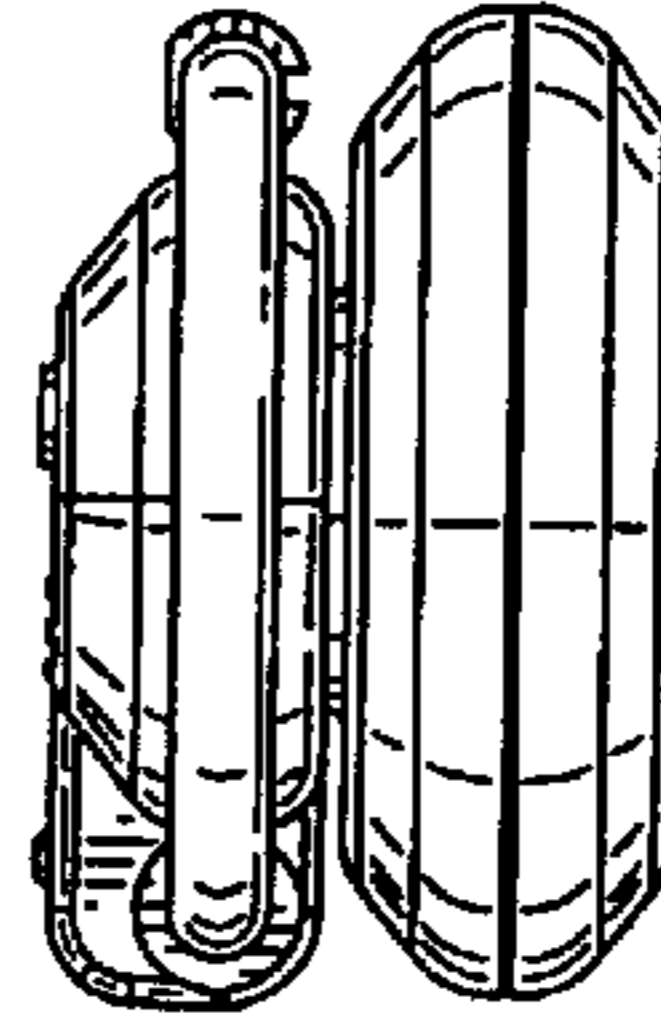

FIG. 4

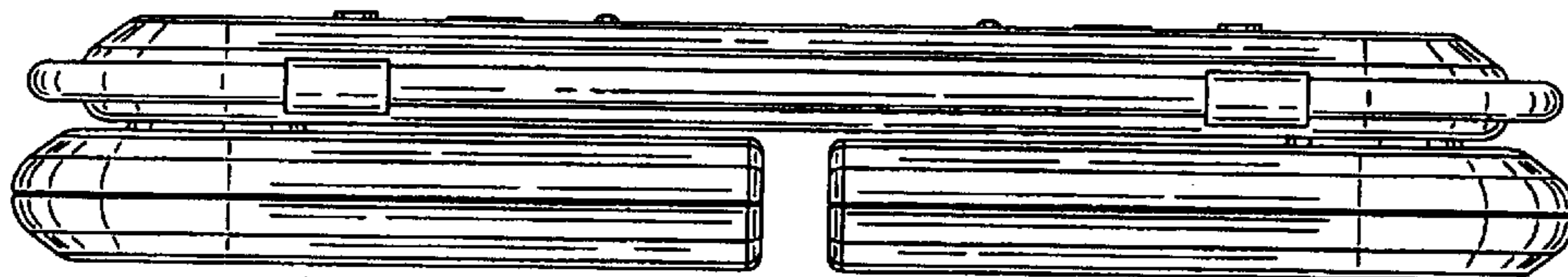

FIG. 5

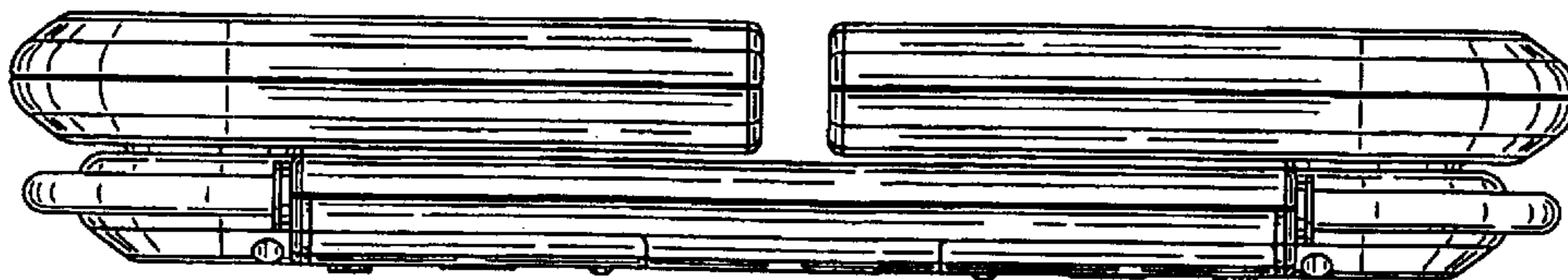

FIG. 6

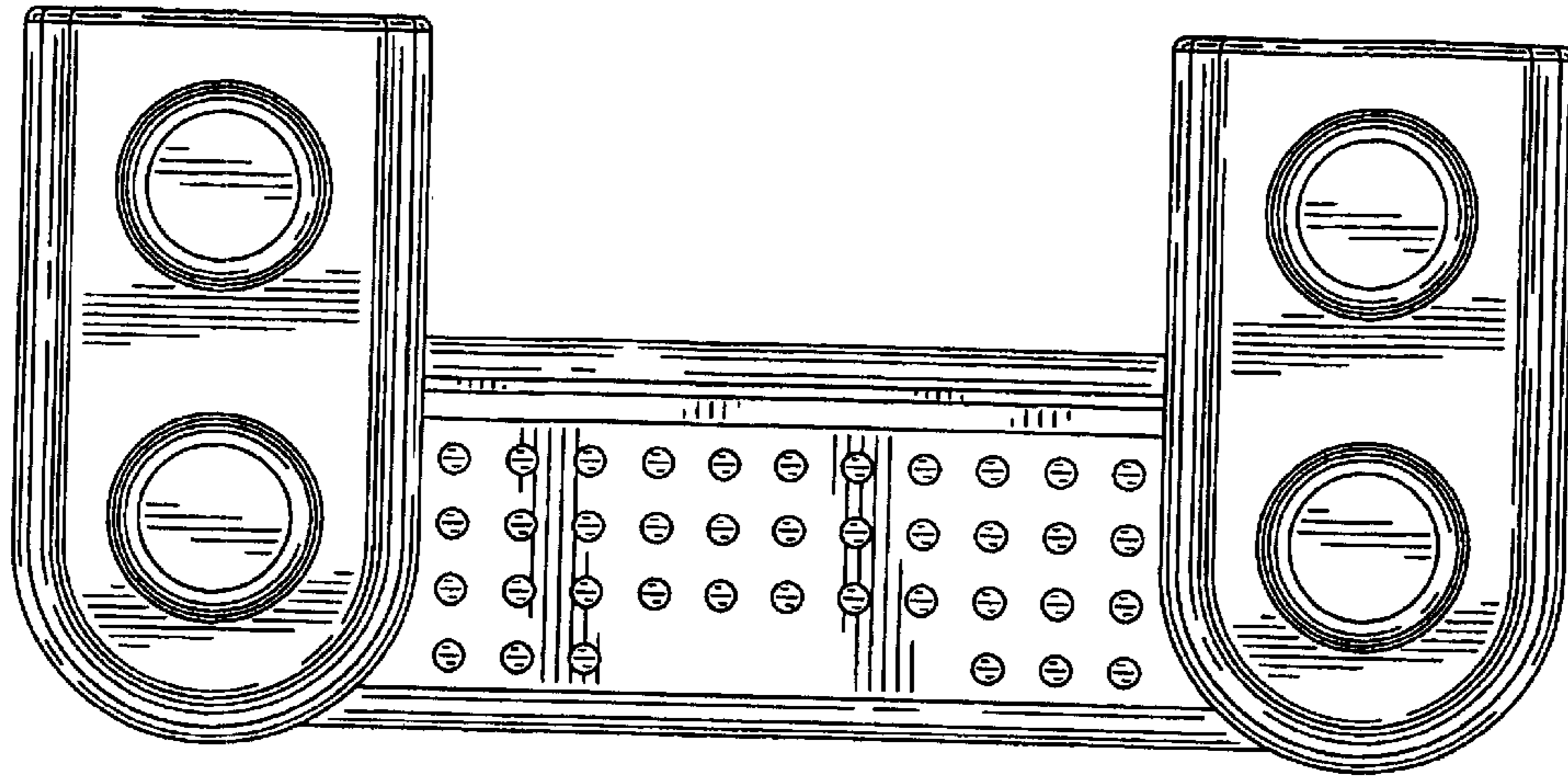

FIG. 7

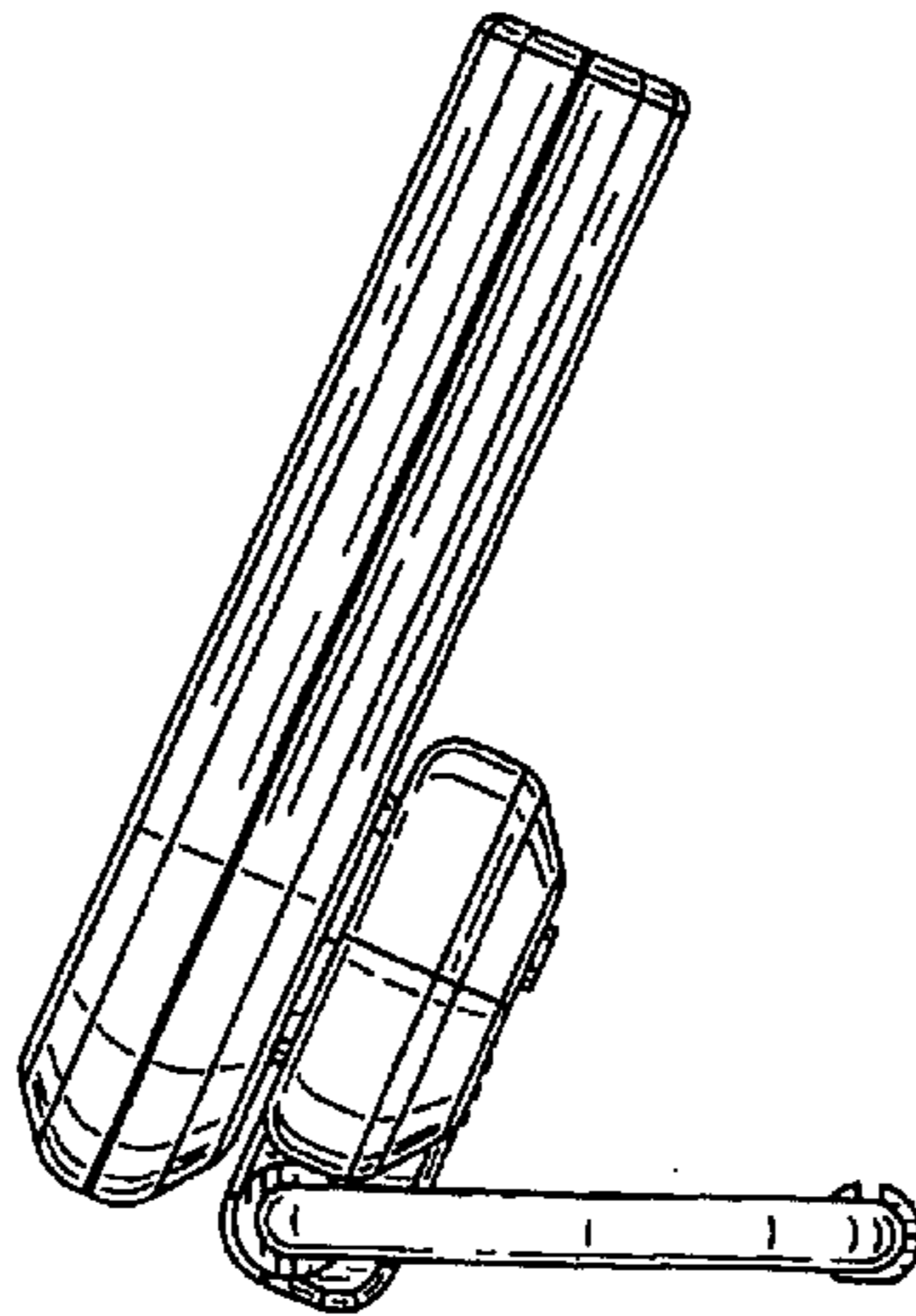

FIG. 8