

US00D539784S

(12) **United States Design Patent** (10) **Patent No.:** **US D539,784 S**
Yasuda et al. (45) **Date of Patent:** **** Apr. 3, 2007**

(54) **SPEAKER** D277,278 S * 1/1985 Matsuda D14/214
D281,241 S * 11/1985 Kawachi D14/210
(75) Inventors: **Koji Yasuda**, Hamamatsu (JP); D295,857 S * 5/1988 Nagashima D14/210
Masazumi Morinaga, Hamamatsu (JP) D305,892 S * 2/1990 Freed D14/213

(73) Assignee: **Roland Corporation**, Hamamatsu (JP)
(**) Term: **14 Years**

* cited by examiner
Primary Examiner—Nanda Bondade
(74) *Attorney, Agent, or Firm*—Foley & Lardner LLP

(21) Appl. No.: **29/236,169**
(22) Filed: **Aug. 12, 2005**

(57) **CLAIM**

We claim the ornamental design for a speaker, as shown and described.

(30) **Foreign Application Priority Data**

Apr. 28, 2005 (JP) 2005-012732

DESCRIPTION

(51) **LOC (8) Cl.** **14-01**
(52) **U.S. Cl.** **D14/214**
(58) **Field of Classification Search** D14/204,
D14/209–215, 172; 181/143–144, 147–148,
181/150, 157, 198–199, 151, 153; 381/300–302,
381/306, 333, 345, 361–364, 386–388, 332,
381/336

FIG. 1 is a front view of the speaker showing our new design;
FIG. 2 is a rear view thereof;
FIG. 3 is a top view thereof;
FIG. 4 is a bottom view thereof;
FIG. 5 is a left side view thereof;
FIG. 6 is a right side view thereof; and,
FIG. 7 is a perspective view thereof.

See application file for complete search history.

The ornamental design which is claimed is shown in solid lines in the drawings. The broken line showing of the drawing is for illustrative purposes only and forms no part of the claimed design.

(56) **References Cited**

U.S. PATENT DOCUMENTS

D276,153 S * 10/1984 Iijima D14/214
D276,227 S * 11/1984 Nakamura D14/214

1 Claim, 7 Drawing Sheets

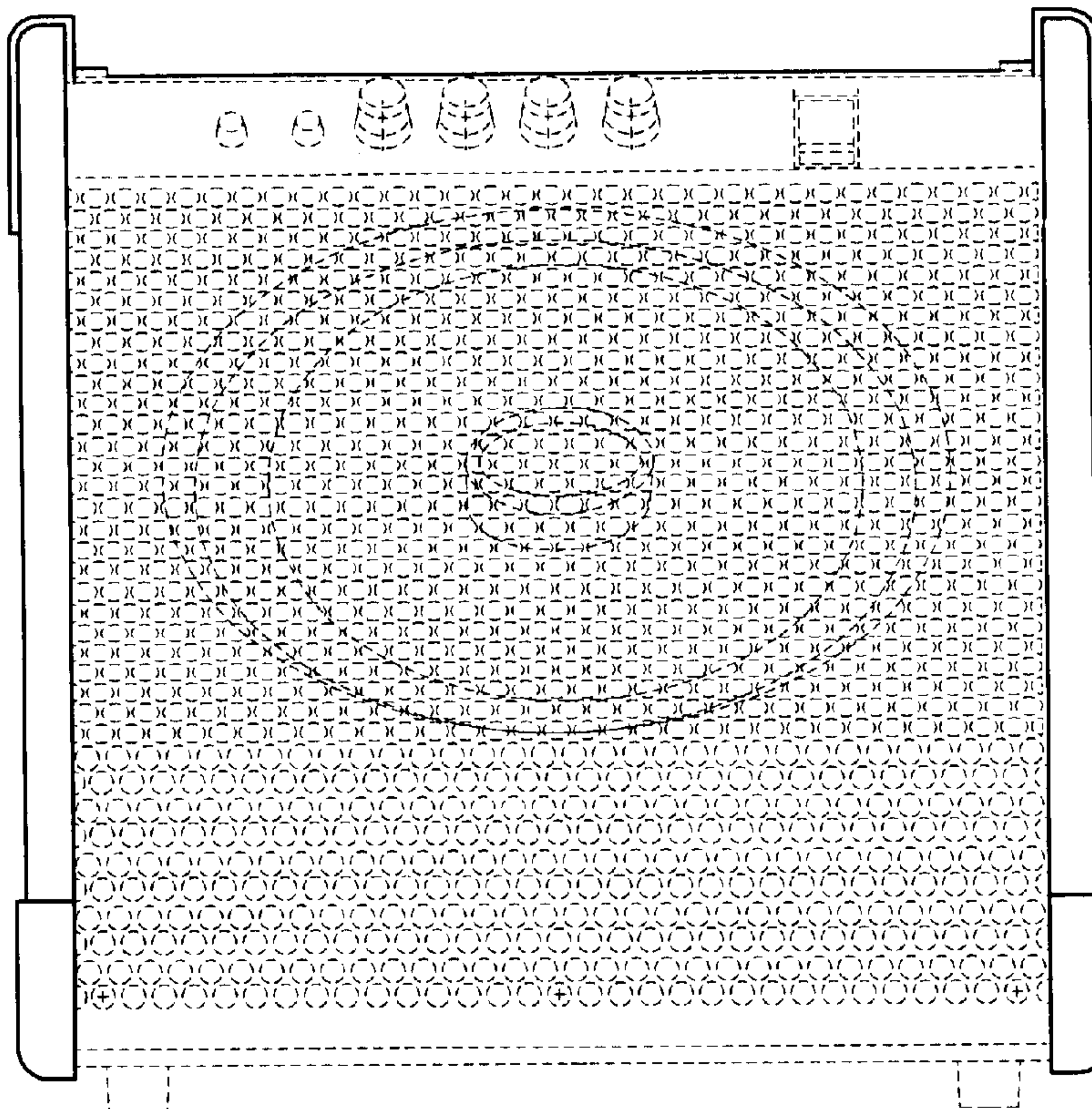

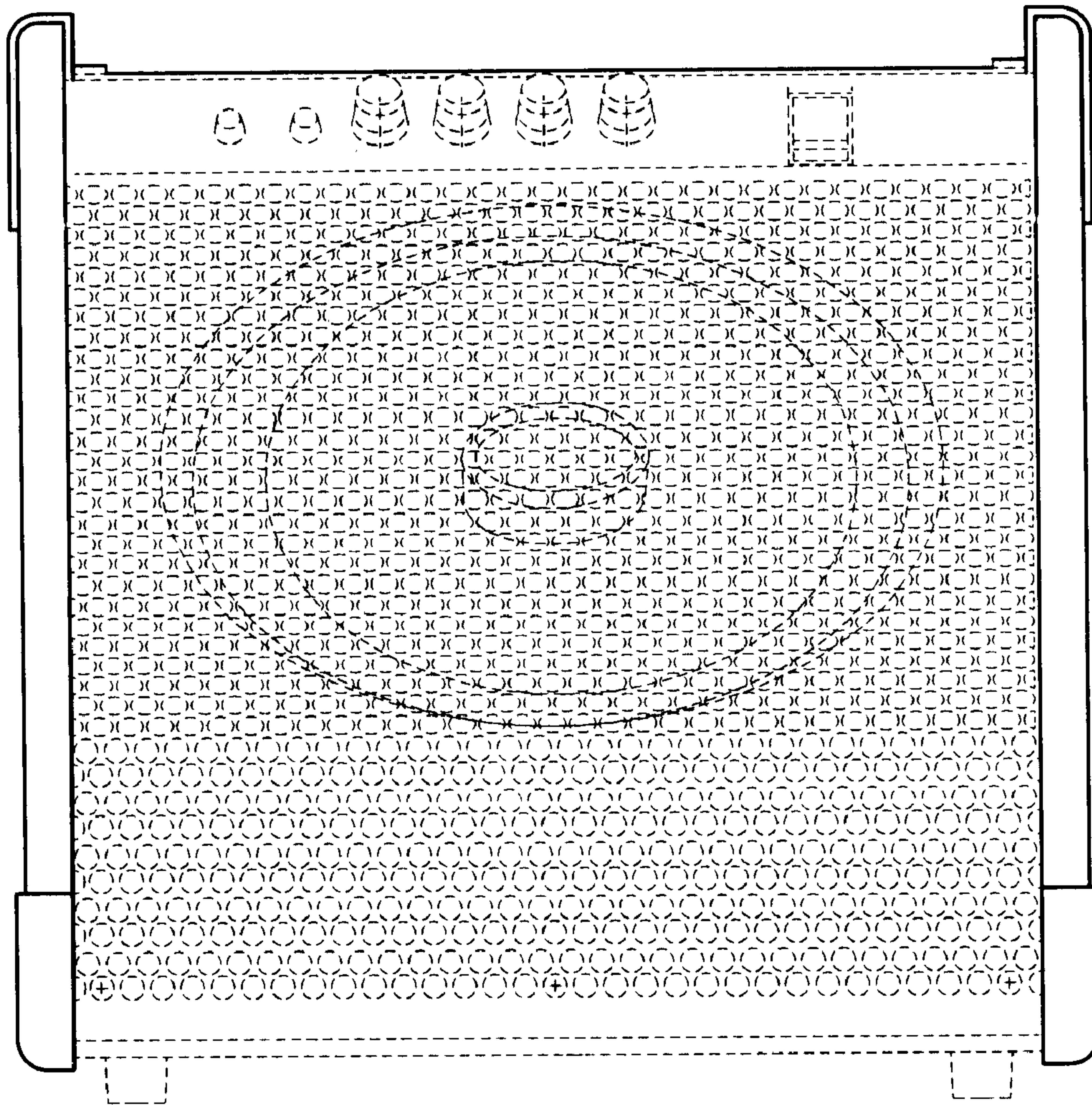

FIG. 1

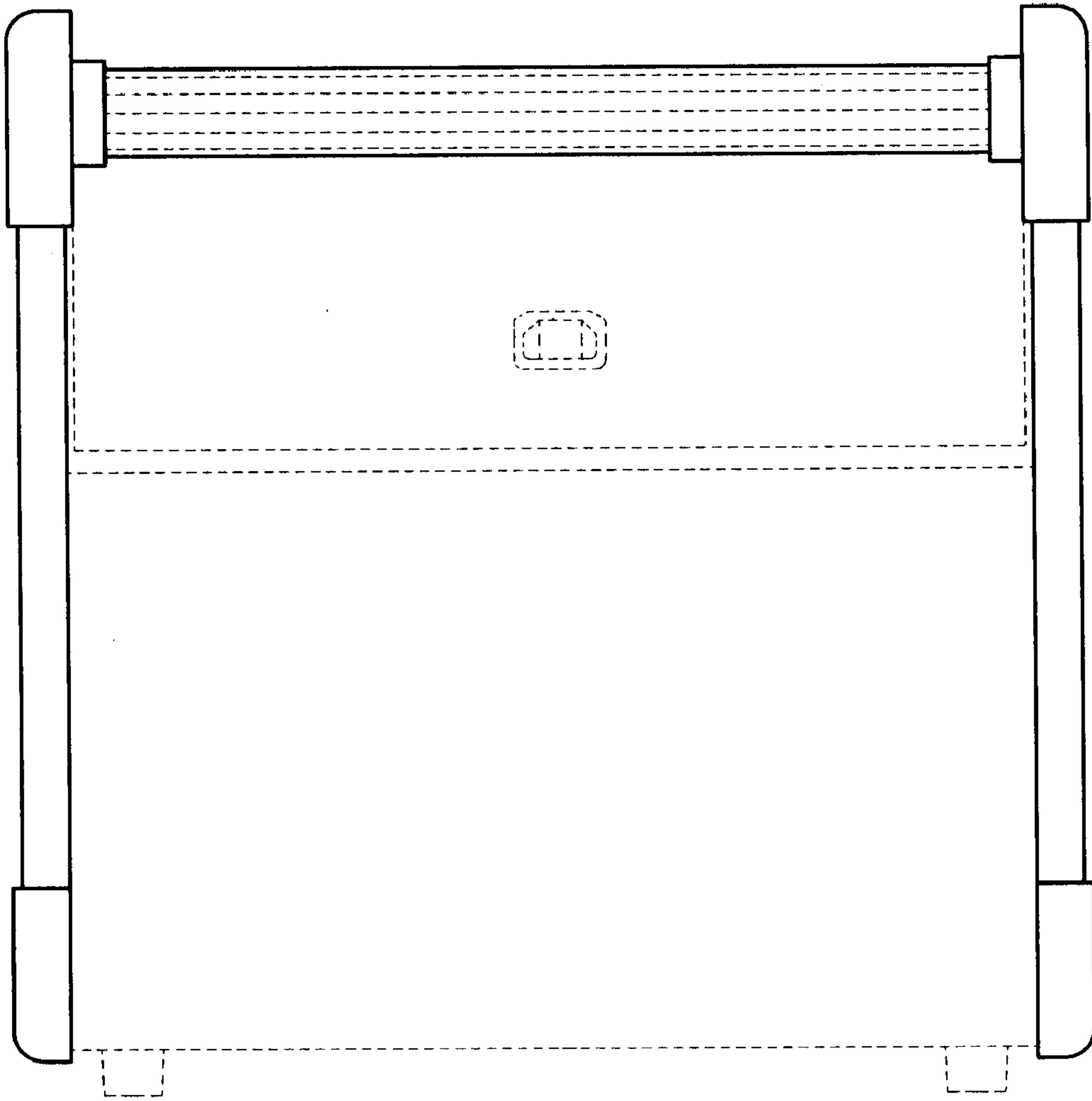

FIG. 2

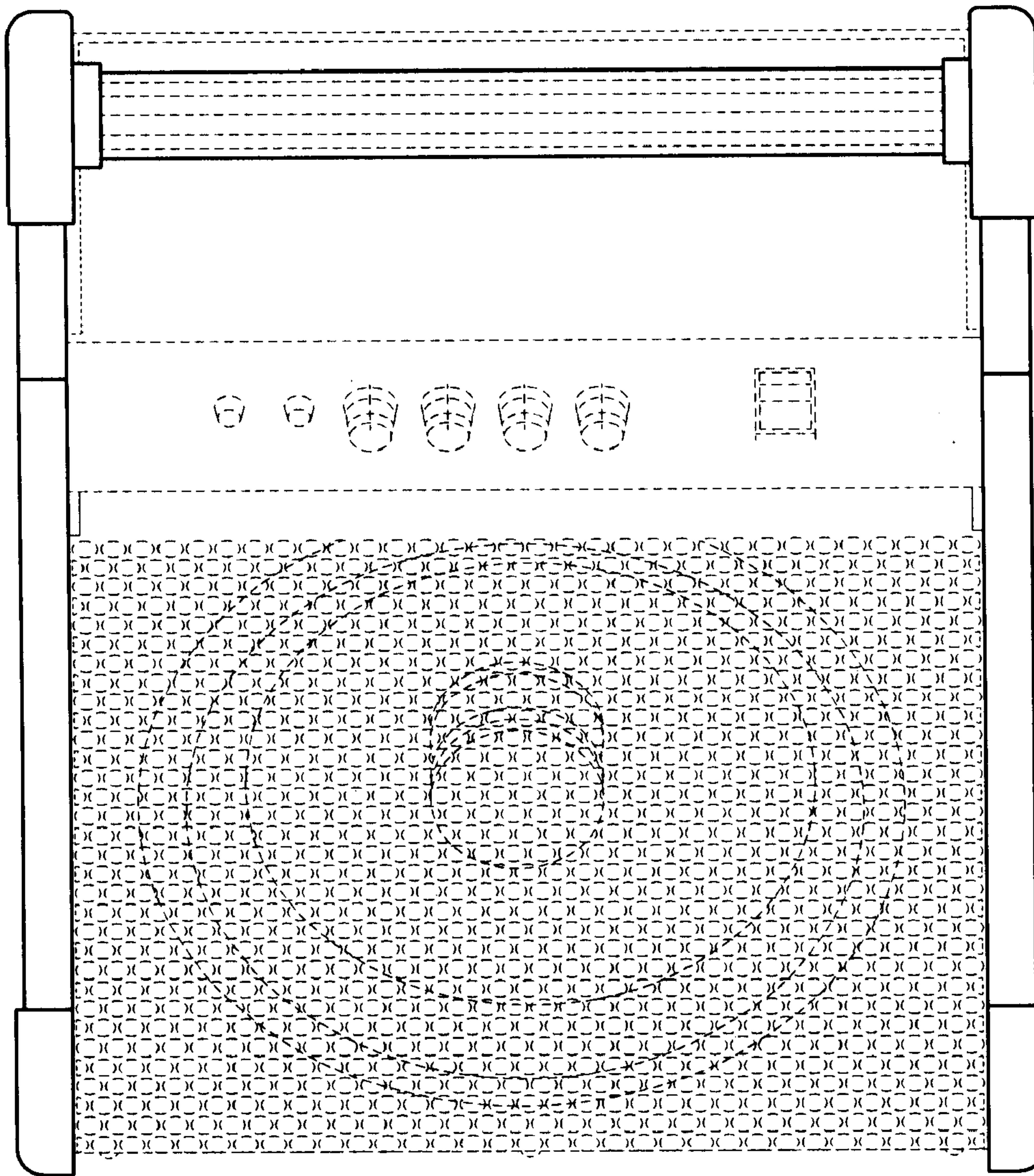

FIG. 3

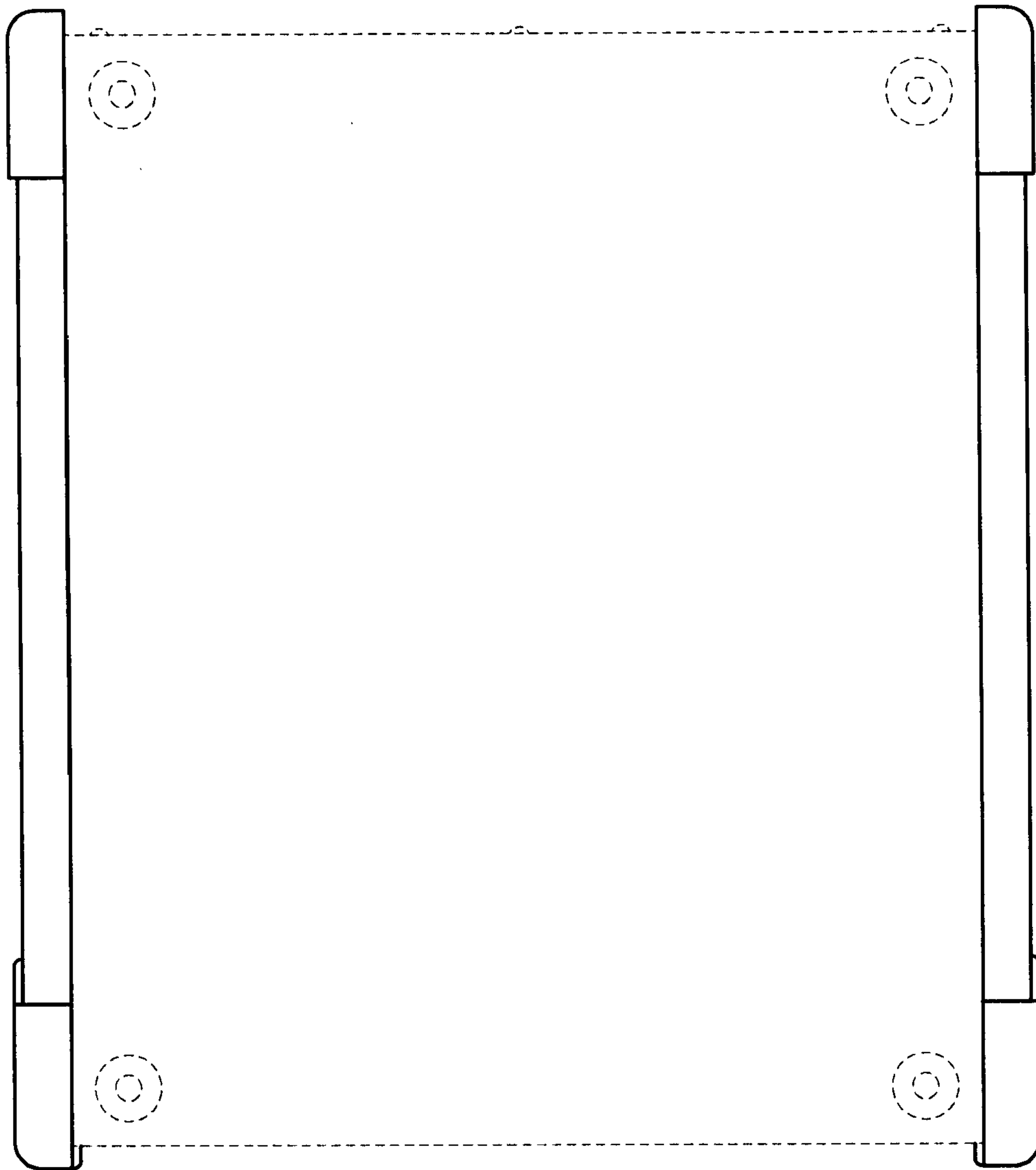

FIG. 4

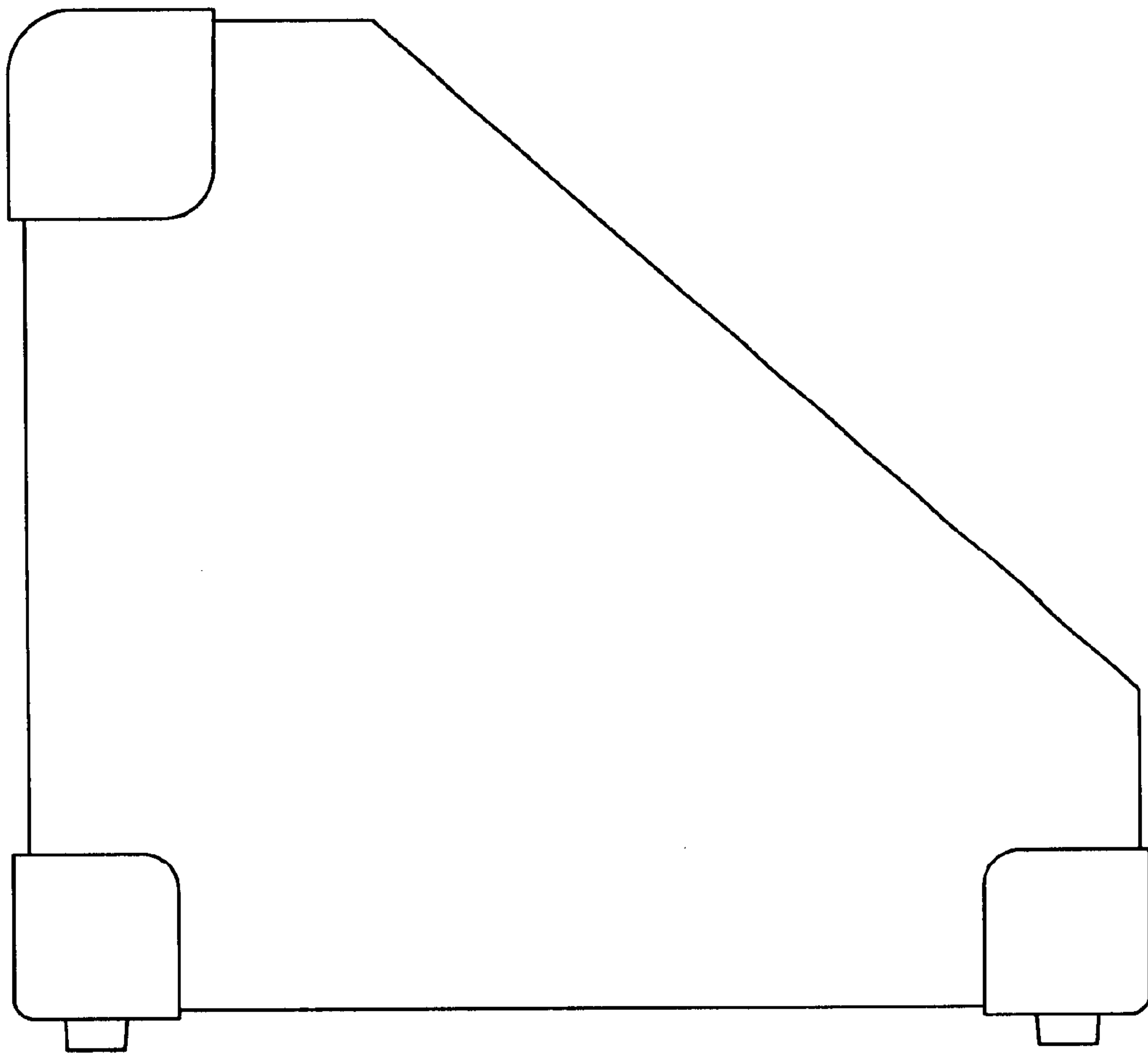

FIG. 5

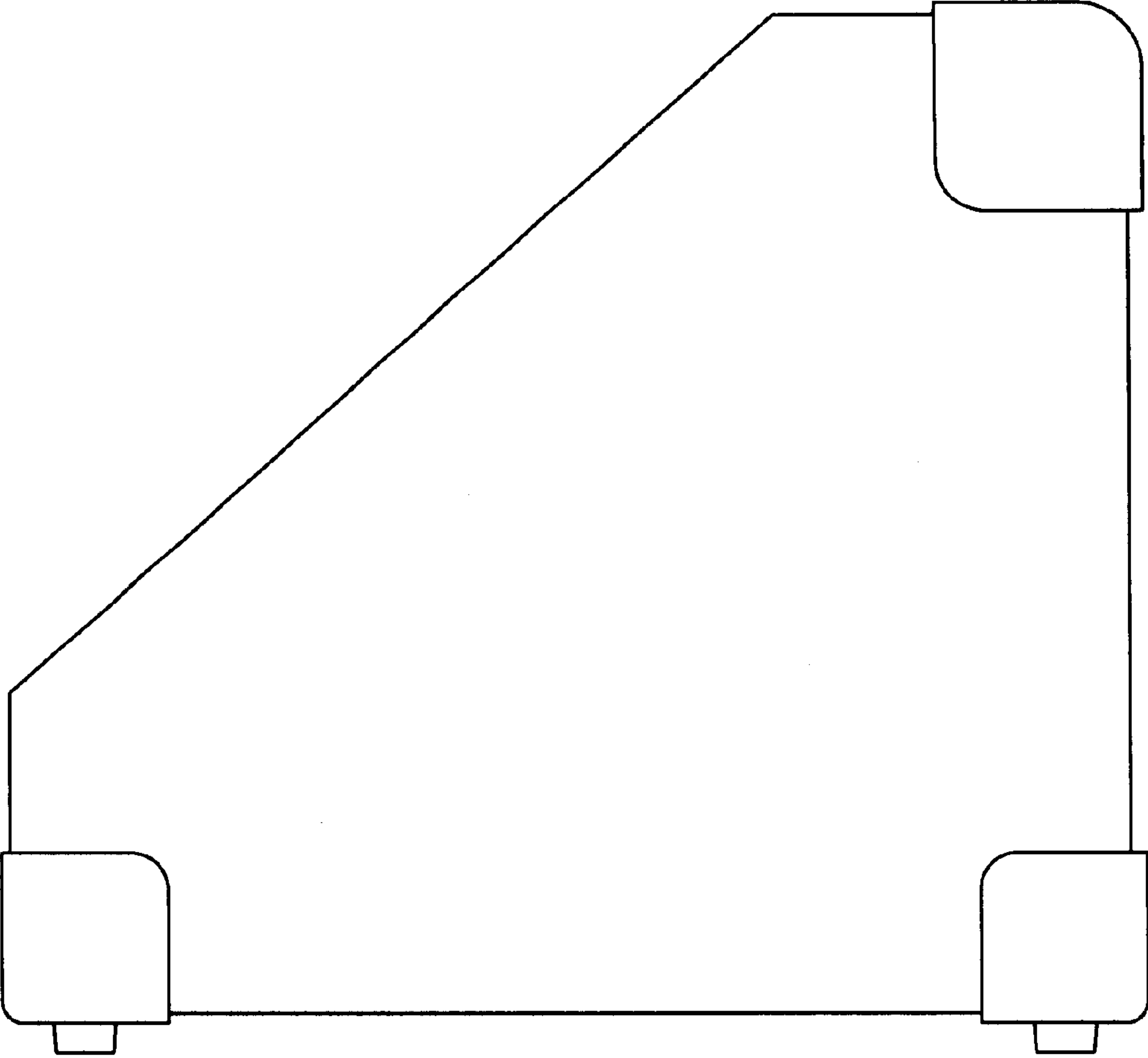

FIG. 6

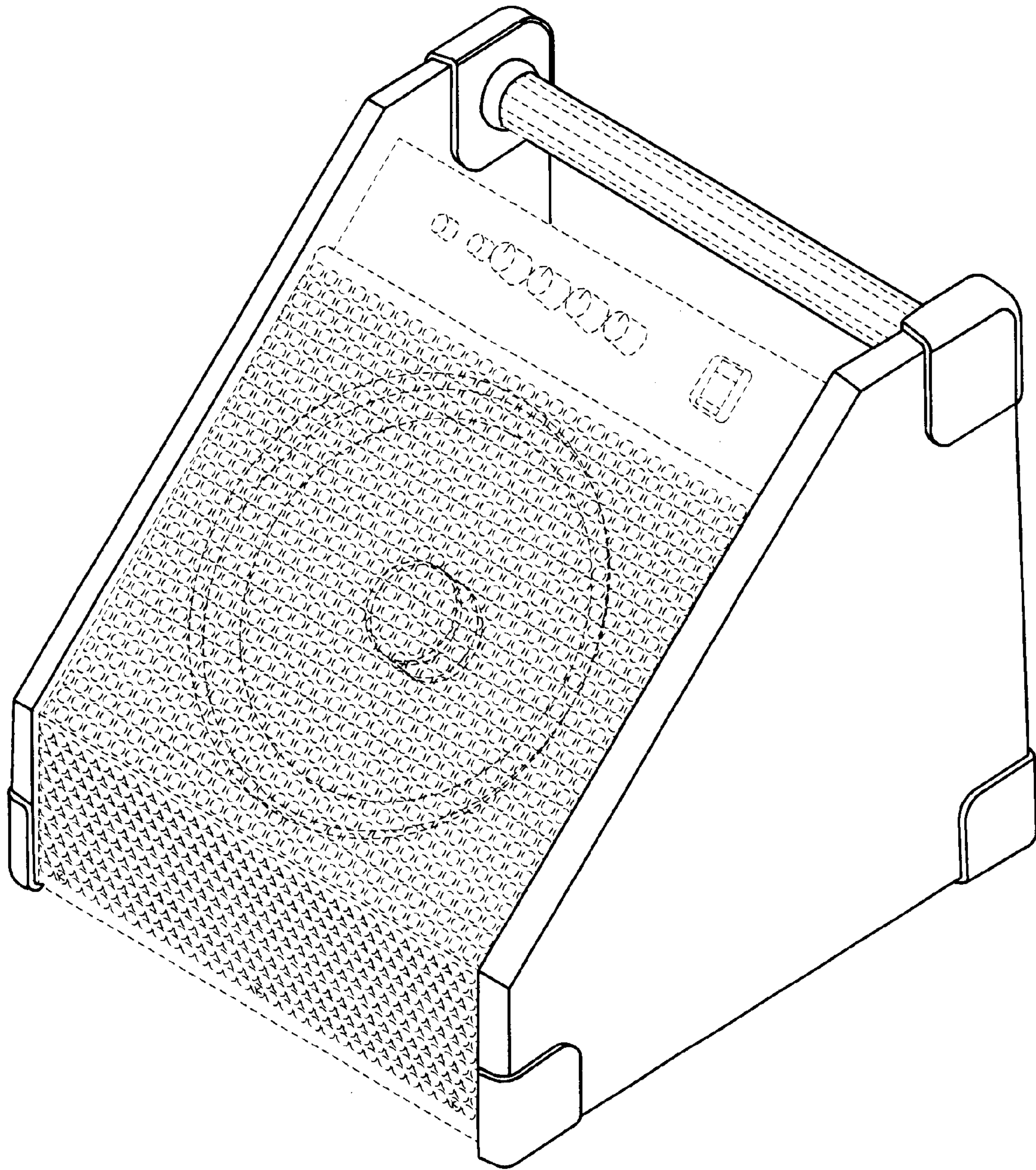

FIG. 7