



US00D539735S

(12) **United States Design Patent**
Suckle

(10) **Patent No.:** **US D539,735 S**

(45) **Date of Patent:** **** Apr. 3, 2007**

(54) **LINE CONDITIONER**

(75) Inventor: **Mitchell Suckle**, Long Beach, CA (US)

(73) Assignee: **Belkin Corporation**, Compton, CA (US)

(**) Term: **14 Years**

(21) Appl. No.: **29/235,938**

(22) Filed: **Aug. 8, 2005**

(51) **LOC (8) Cl.** **13-02**

(52) **U.S. Cl.** **D13/110**

(58) **Field of Classification Search** D13/110,
D13/101, 118, 162, 184, 199; 307/65, 72,
307/85-87; 361/643, 679, 691, 728; 439/650-654
See application file for complete search history.

(56) **References Cited**

U.S. PATENT DOCUMENTS

- D356,297 S * 3/1995 Carl et al. D13/160
- 5,589,718 A * 12/1996 Lee 307/72
- 5,649,839 A * 7/1997 Yu 439/650
- D392,615 S * 3/1998 Basile D13/123

- D405,092 S * 2/1999 Ohshima et al. D14/239
- D418,136 S * 12/1999 Kizawa D14/188
- D464,617 S * 10/2002 Reynolds D13/110

* cited by examiner

Primary Examiner—Prabhakah Deshmukh

Assistant Examiner—Derrick Holland

(74) *Attorney, Agent, or Firm*—Bryan Cave LLP

(57) **CLAIM**

I claim the ornamental design for a line conditioner, as shown and described.

DESCRIPTION

FIG. 1 is a front elevational view of the line conditioner; FIG. 2 is a rear elevational view thereof; FIG. 3 is a top view thereof; FIG. 4 is a bottom view thereof; FIG. 5 is a left side elevational view thereof; FIG. 6 is a right side elevational view thereof; and, FIG. 7 is a front, right, top perspective view thereof. The broken lines in the drawings are for illustrative purposes only and form no part of the claimed design.

1 Claim, 3 Drawing Sheets

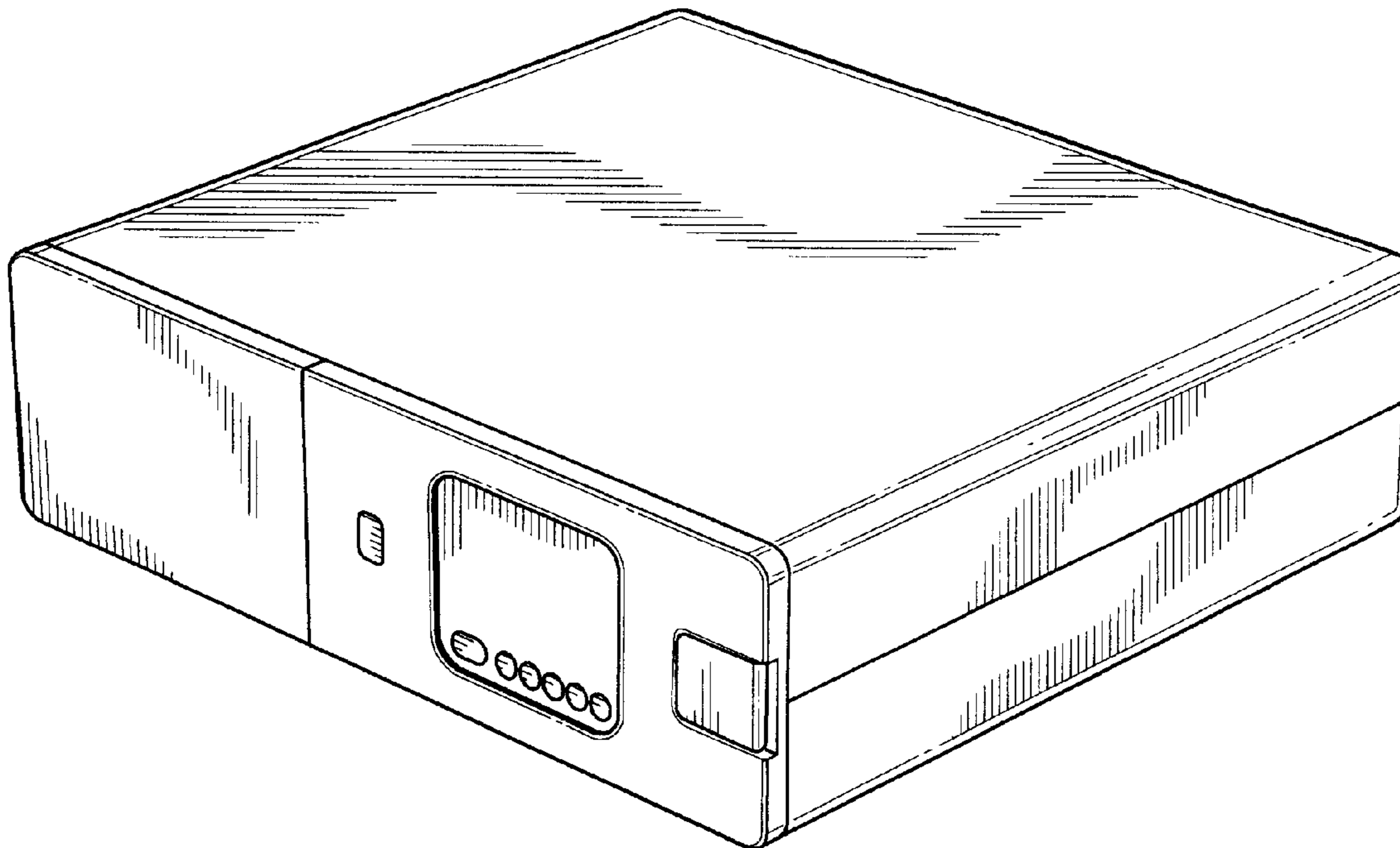

FIG.1

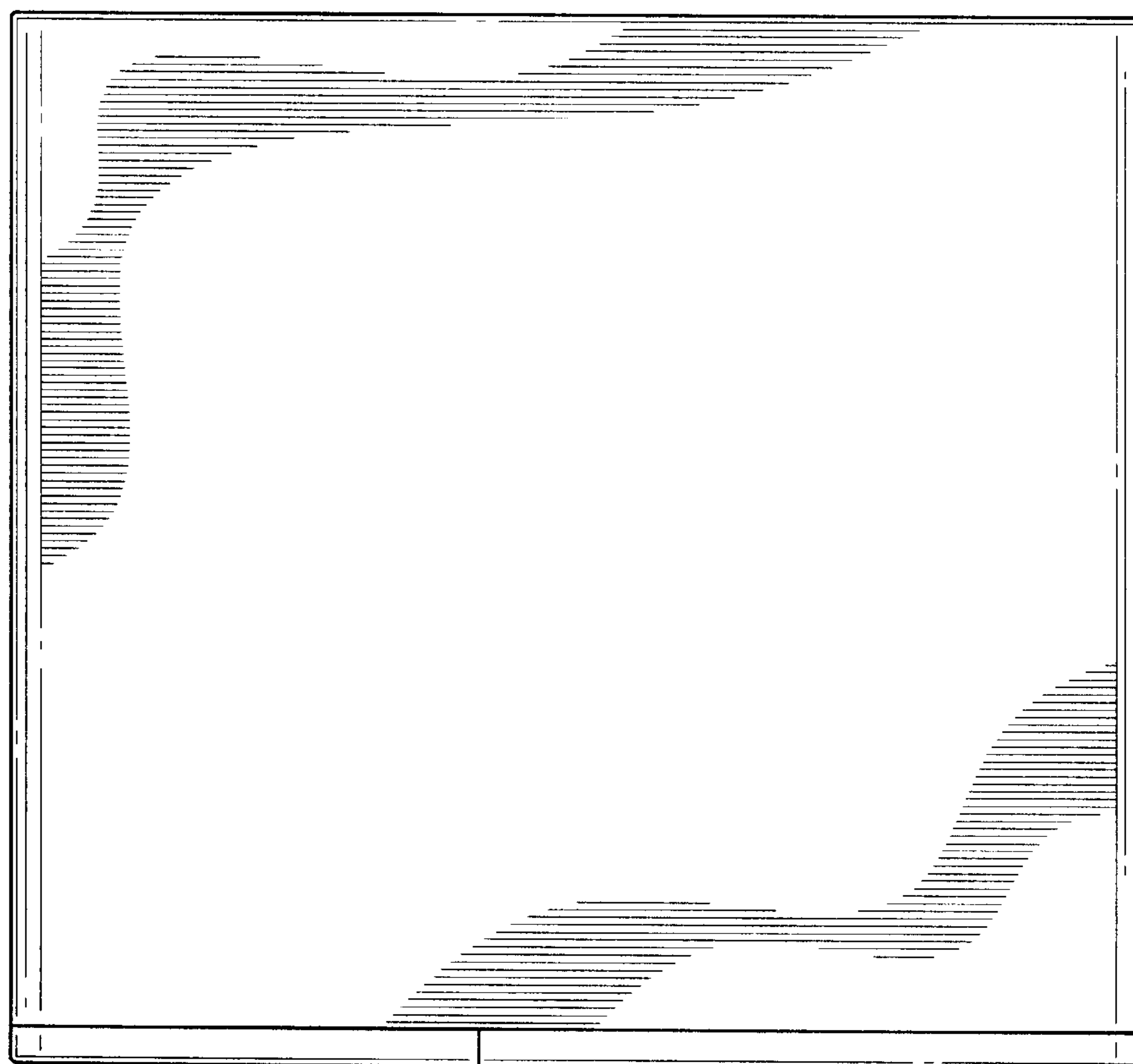
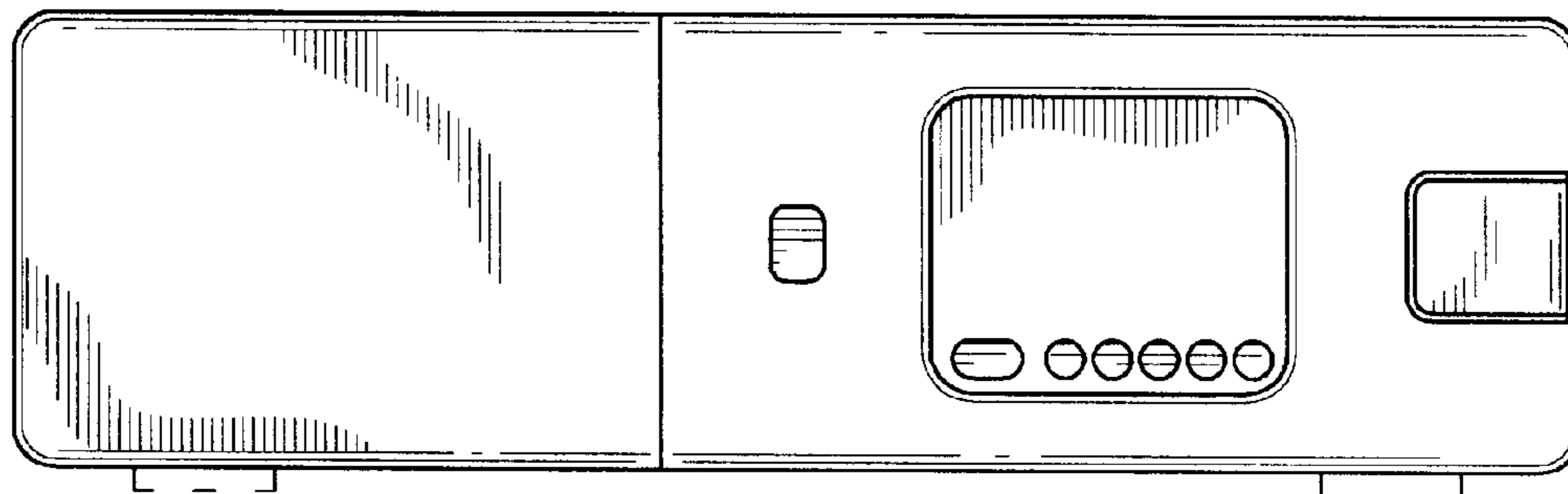

FIG.3

FIG.2

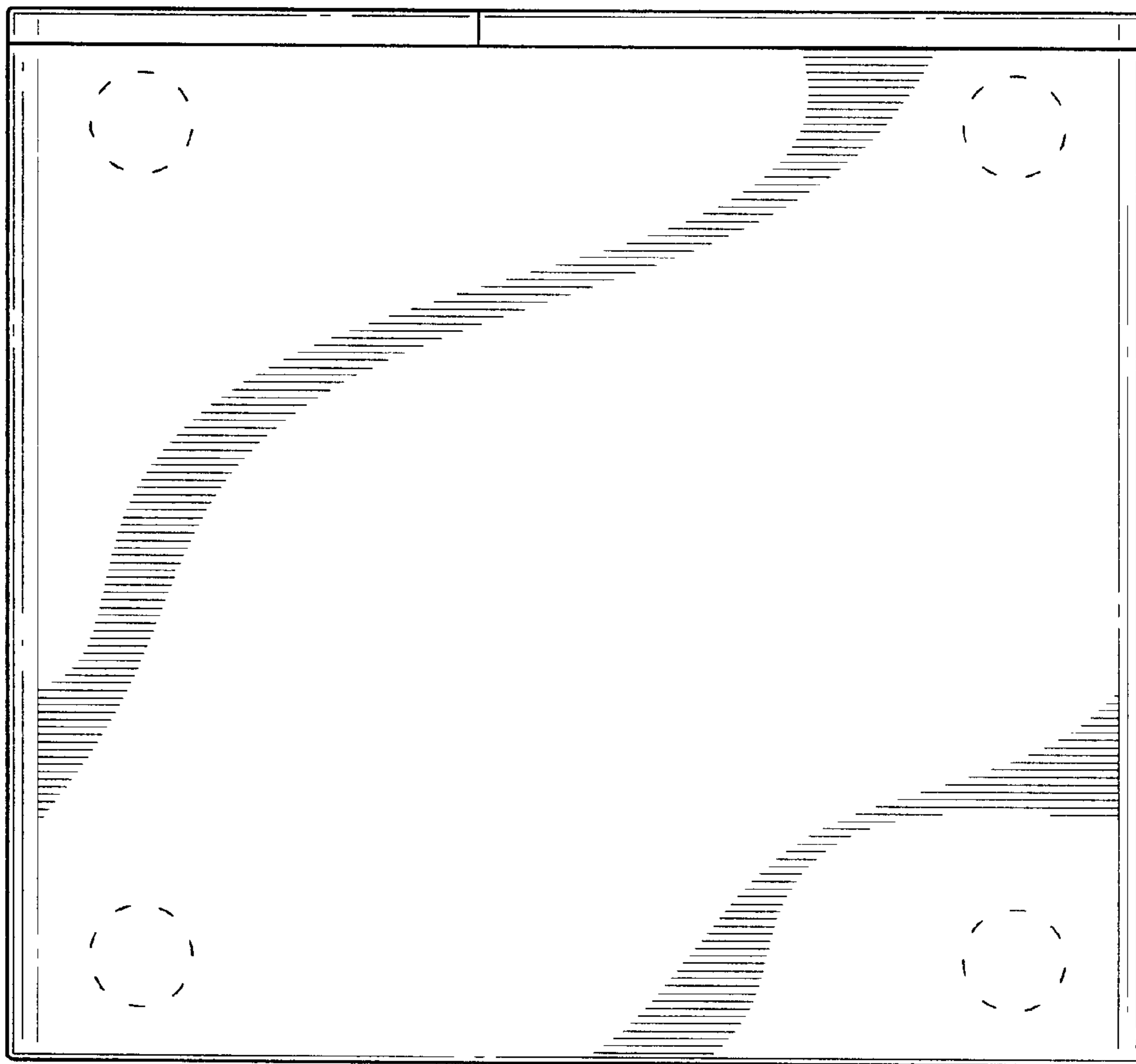
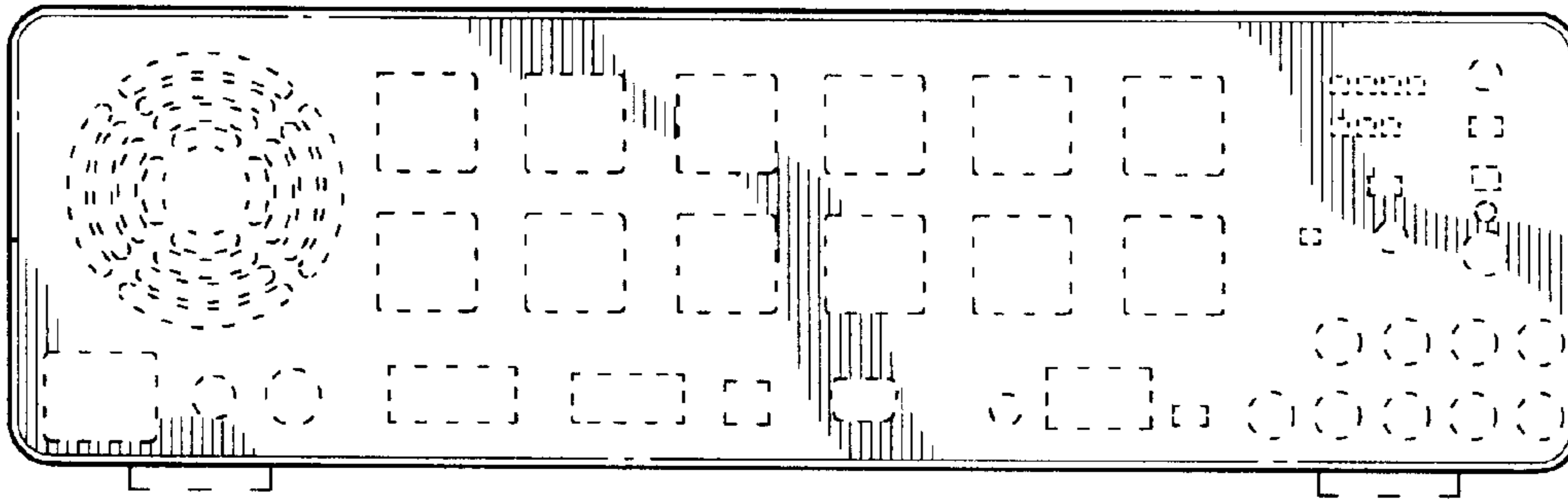

FIG.4

FIG.5

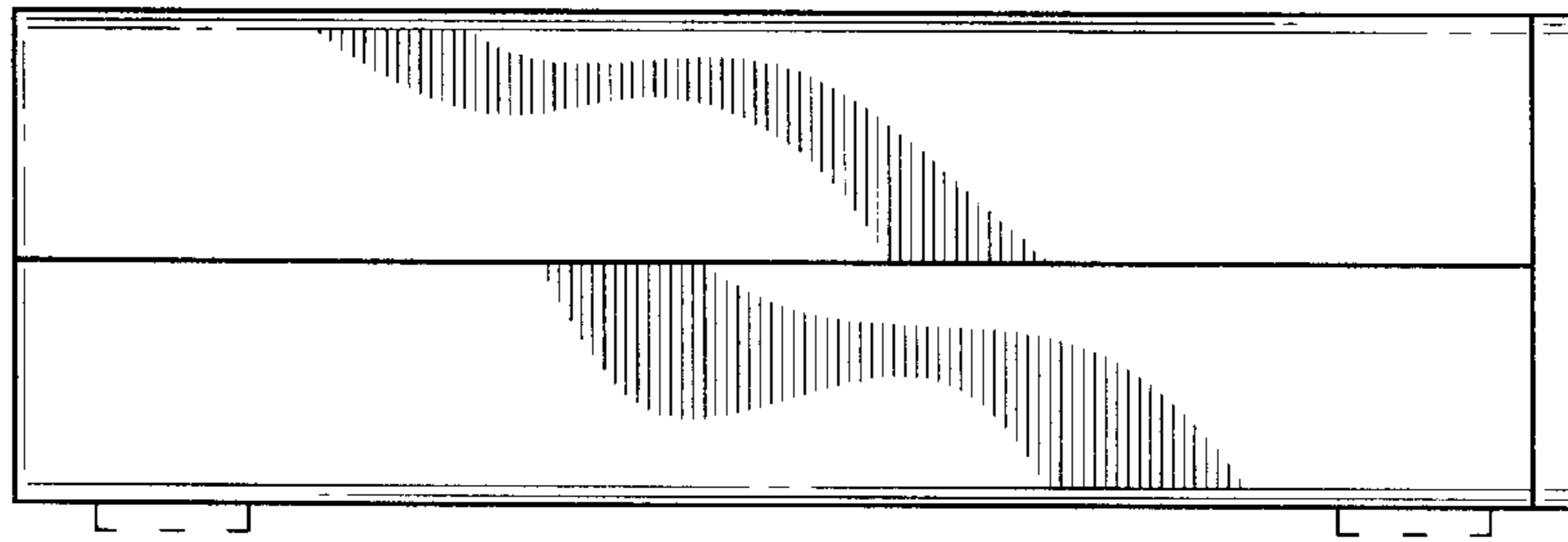

FIG.6

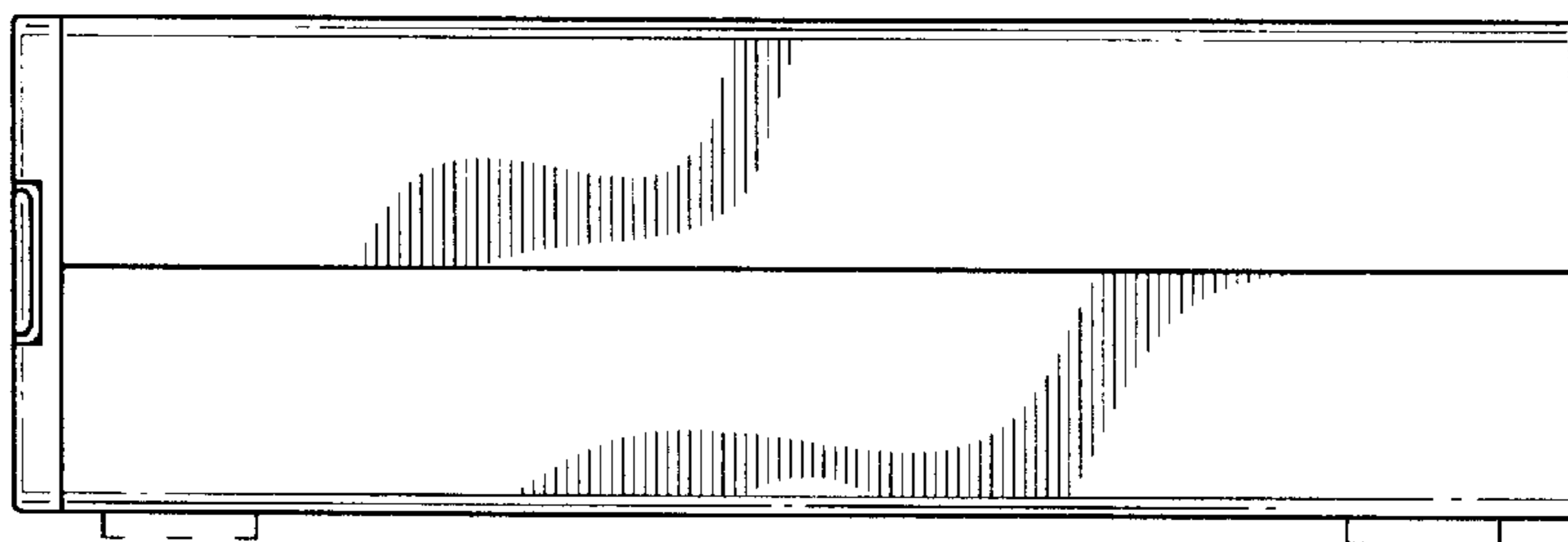

FIG.7

