

US00D539630S

(12) **United States Design Patent**
Imoto

(10) **Patent No.: US D539,630 S**

(45) **Date of Patent: ** Apr. 3, 2007**

(54) **TOOL HANDLE**

(75) Inventor: **Koji Imoto, Miki (JP)**

(73) Assignee: **Estwing Manufacturing Company,**
Rockford, IL (US)

(**) Term: **14 Years**

(21) Appl. No.: **29/236,804**

(22) Filed: **Aug. 23, 2005**

(51) **LOC (8) Cl. 08-05**

(52) **U.S. Cl. D8/107**

(58) **Field of Classification Search** D8/45,
D8/47, 300, 303, 107, DIG. 7, DIG. 8, 75-81,
D8/88-89; D7/393, 395, 401.2, 642, 664,
D7/695; D21/756; 81/177.2; 16/430, 431,
16/427, 429

See application file for complete search history.

(56) **References Cited**

U.S. PATENT DOCUMENTS

81,855 A	9/1868	Willard	
149,313 A	4/1874	Hutchins	
187,871 A	2/1877	Langerfeld	
542,989 A	7/1895	Brooks	
D30,111 S	1/1899	Thomson	
743,590 A	11/1903	Tarbox	
1,550,894 A	8/1925	Erickson	
1,647,576 A	11/1927	Nowka et al.	
2,087,148 A	7/1937	Hempy	
2,103,008 A	12/1937	Kinasi	
2,300,840 A	11/1942	Huxel	
2,325,227 A	7/1943	Chaddock	
3,134,574 A	5/1964	Reuterfors	
3,587,121 A	6/1971	Morrow	
3,774,252 A	11/1973	Cantales	
4,805,494 A	* 2/1989	Santoro	81/20
4,844,416 A	7/1989	Hand	
5,054,180 A	10/1991	Combs	
5,695,172 A	12/1997	Hreha	
5,823,077 A	10/1998	Macor	
D410,188 S	5/1999	Dossett	
5,957,429 A	9/1999	Khachatoorian	

6,092,442 A	7/2000	Macor	
D436,823 S	* 1/2001	Wrensch	D8/89
D445,014 S	7/2001	Douglas et al.	
D453,463 S	* 2/2002	Chang	D8/107
6,471,186 B1	10/2002	Lawless	
D473,779 S	* 4/2003	Noland	D8/107
D477,646 S	* 7/2003	Vito	D21/756
6,629,684 B2	10/2003	Youngren et al.	
RE38,892 E	* 11/2005	Ryu	D8/80
D511,082 S	* 11/2005	Chen	D8/80
2002/0157505 A1	10/2002	Wang	
2003/0167884 A1	9/2003	Macor	

FOREIGN PATENT DOCUMENTS

CA 243286 A 9/1924

OTHER PUBLICATIONS

ESTWING Catalog No. 601, Estwing Manufacturing Company, p. 32 (Jun. 2001).
Shark Corporation, "Shark Grip Nail Pullers and Crowbars," Catalogue (1998).

* cited by examiner

Primary Examiner—Alan P. Douglas

Assistant Examiner—Barbara Fox

(74) *Attorney, Agent, or Firm*—Gardner Carton & Douglas LLP

(57) **CLAIM**

The ornamental design for a tool handle, as shown and described.

DESCRIPTION

FIG. 1 is a front perspective view of a first embodiment of a tool handle showing my new design;
FIG. 2 is a rear perspective view of the first embodiment of the tool handle;
FIG. 3 is a front elevation view of the first embodiment of the tool handle;
FIG. 4 is a rear elevation view of the first embodiment of the tool handle;
FIG. 5 is a right side elevation view of the first embodiment of the tool handle;

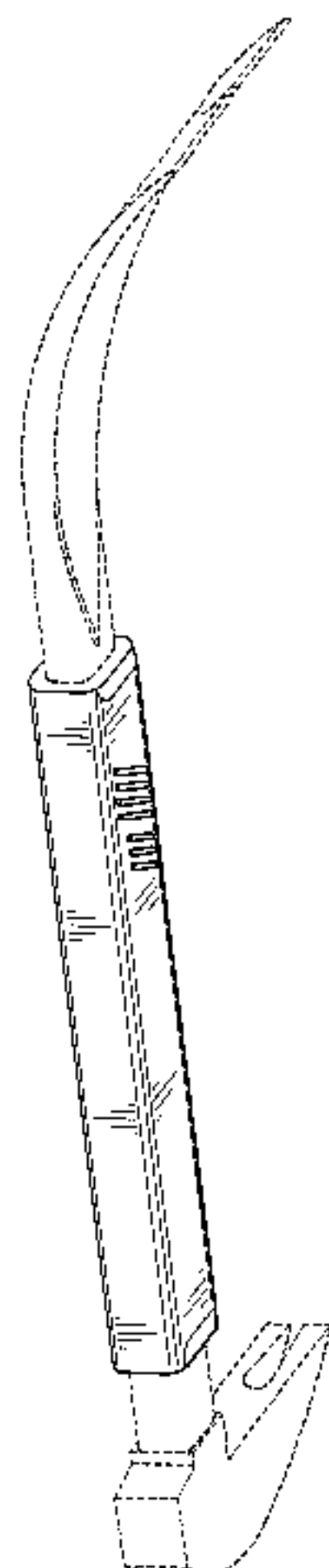

FIG. 6 is a left side elevation view of the first embodiment of the tool handle;

FIG. 7 is a top plan view of the first embodiment of the tool handle, the tool ends being omitted;

FIG. 8 is a bottom plan view of the first embodiment of the tool handle, the tool ends being omitted;

FIG. 9 is a front perspective view of an alternative embodiment of the tool handle of FIG. 1;

FIG. 10 is a rear perspective view of the tool handle of FIG. 9;

FIG. 11 is a front elevation view of the tool handle of FIG. 9, the rear elevation view being a mirror image thereof;

FIG. 12 is a right side elevation view of the tool handle of FIG. 9, the left side elevation view being a mirror image thereof;

FIG. 13 is a top plan view of the tool handle of FIG. 9, the tool ends being omitted; and,

FIG. 14 is a bottom plan view of the tool handle of FIG. 9, the tool ends being omitted.

FIG. 15 is a front perspective view of a second embodiment of the tool handle;

FIG. 16 is a rear perspective view of the second embodiment of the tool handle;

FIG. 17 is a front elevation view of the second embodiment of the tool handle;

FIG. 18 is a rear elevation view of the second embodiment of the tool handle;

FIG. 19 is a right side elevation view of the second embodiment of the tool handle;

FIG. 20 is a left side elevation view of the second embodiment of the tool handle;

FIG. 21 is a top plan view of the second embodiment of the tool handle, the tool ends being omitted;

FIG. 22 is a bottom plan view of the second embodiment of the tool handle, the tool ends being omitted;

FIG. 23 is a front perspective view of an alternative embodiment of the tool handle of FIG. 15;

FIG. 24 is a rear perspective view of the tool handle of FIG. 23;

FIG. 25 is a front elevation view of the tool handle of FIG. 23, the rear elevation view being a mirror image thereof;

FIG. 26 is a right side elevation view of the tool handle of FIG. 23, the left side elevation view being a mirror image thereof;

FIG. 27 is a top plan view of the tool handle of FIG. 23, the tool ends being omitted; and,

FIG. 28 is a bottom plan view of the tool handle of FIG. 23, the tool ends being omitted.

The broken line showings of the tool ends of the tools are for illustrative purposes only and form no part of the claimed design.

1 Claim, 16 Drawing Sheets

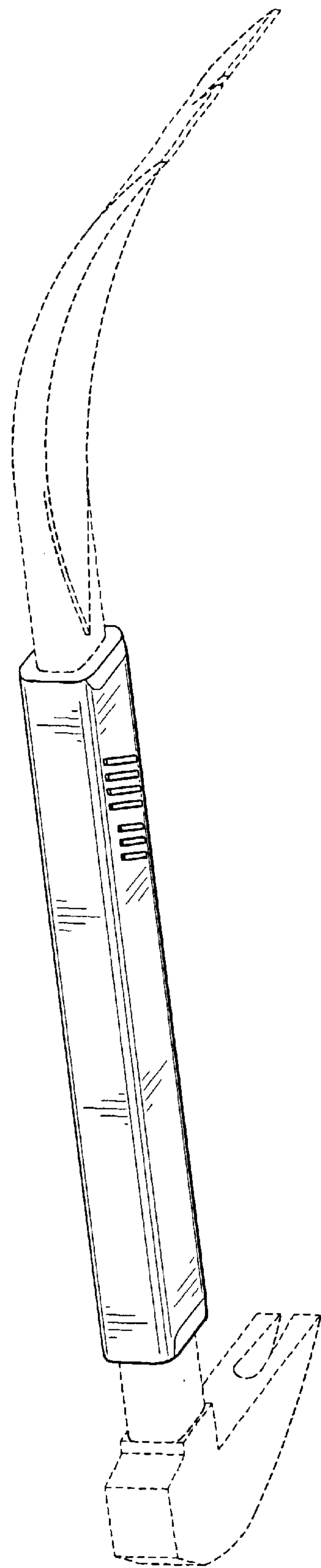

FIG. 1

FIG. 2

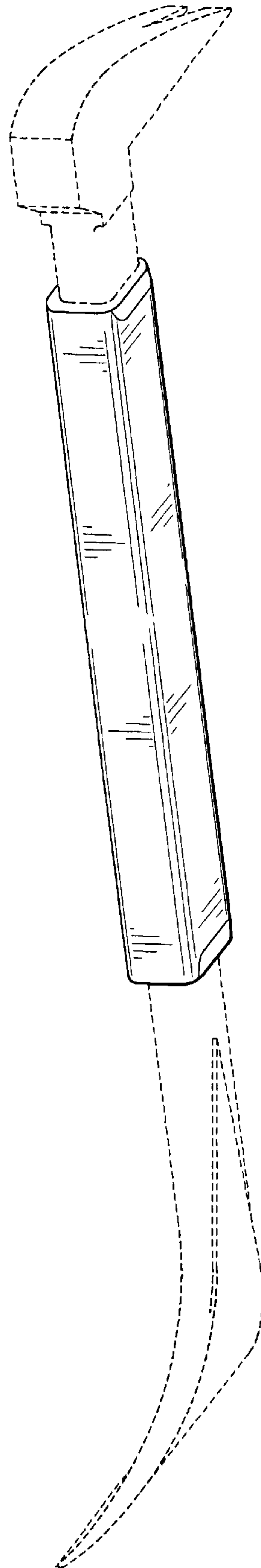

FIG.3

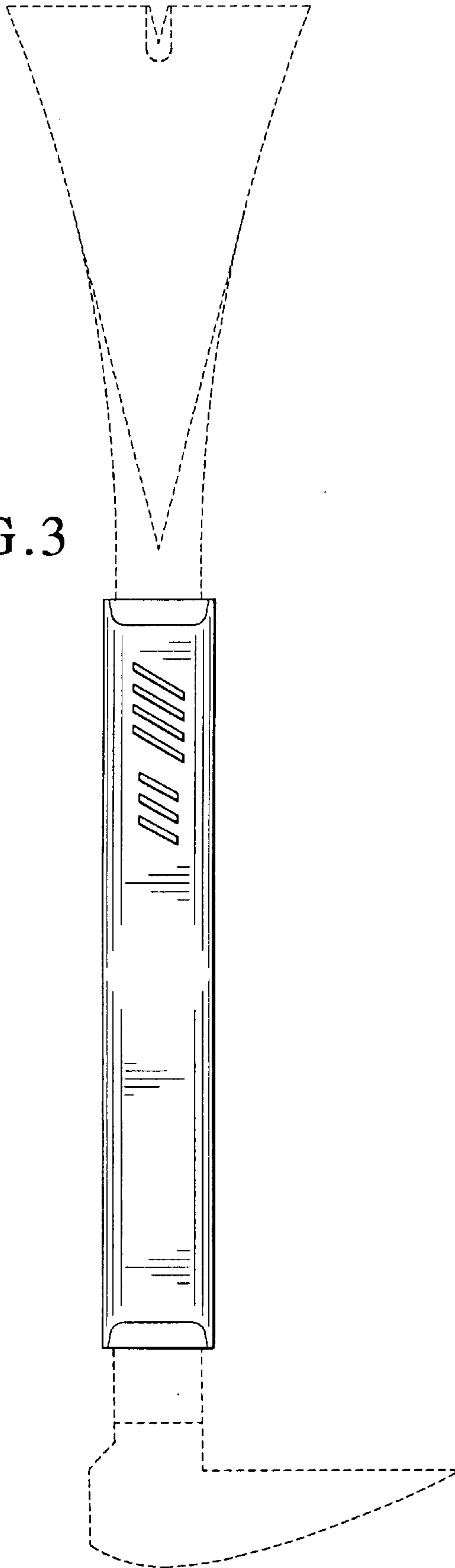

FIG.4

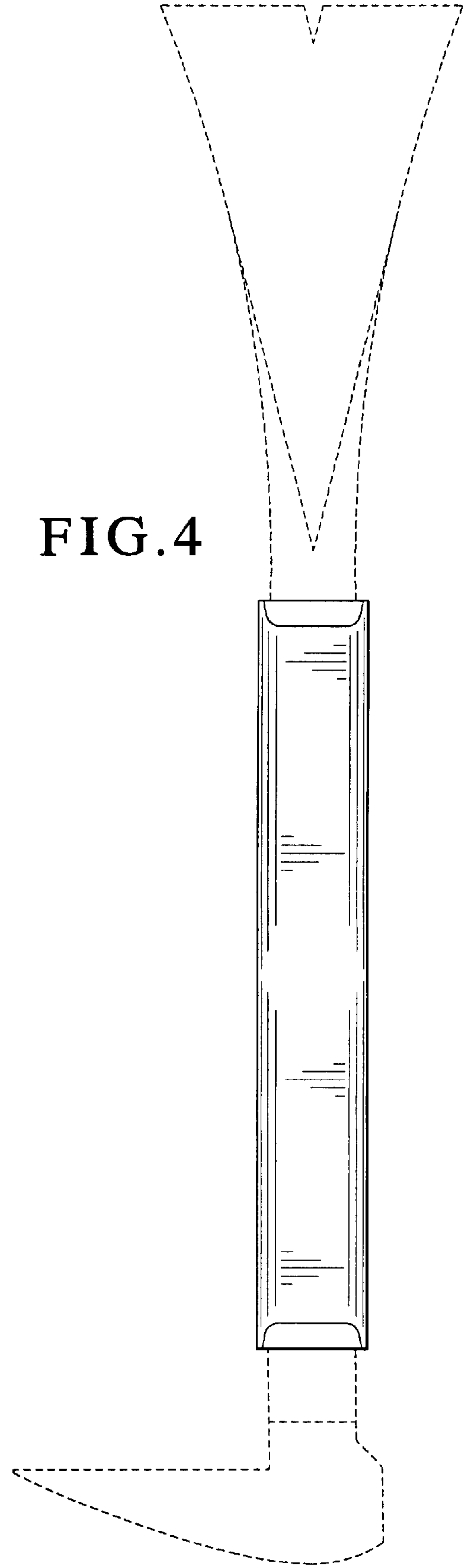

FIG. 5

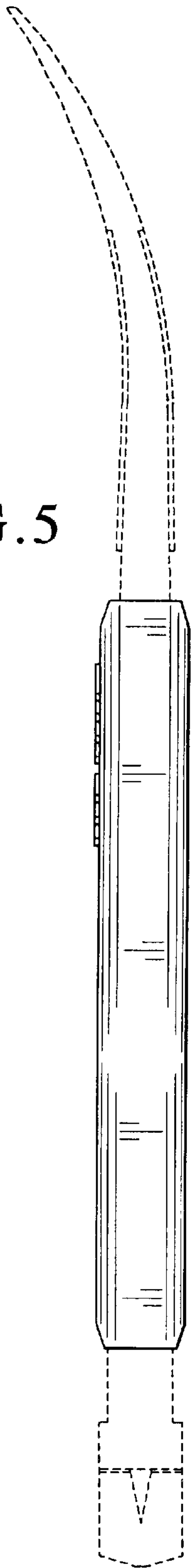

FIG. 6

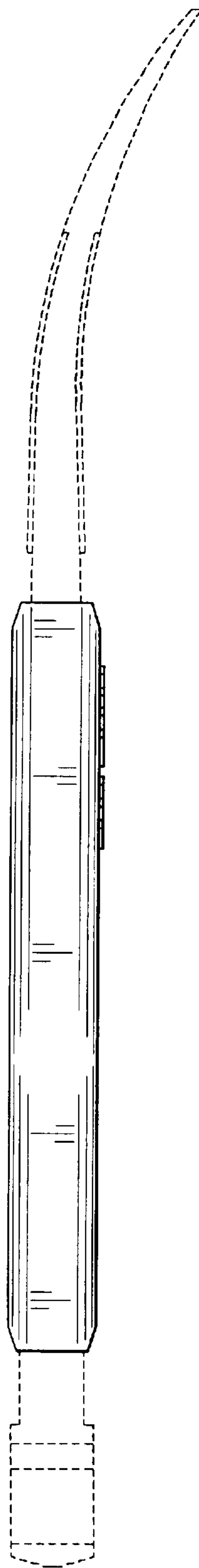

FIG. 7

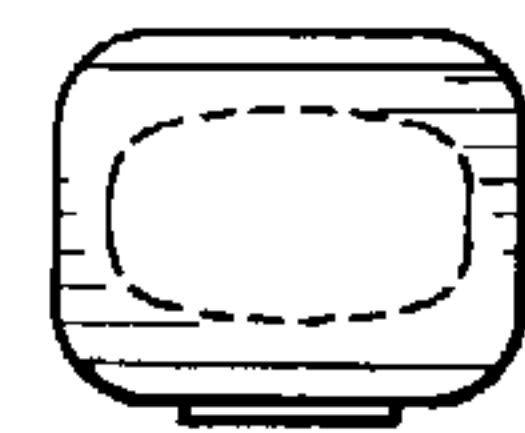
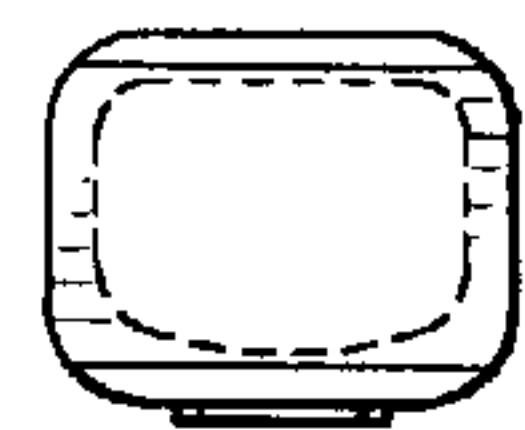

FIG. 8



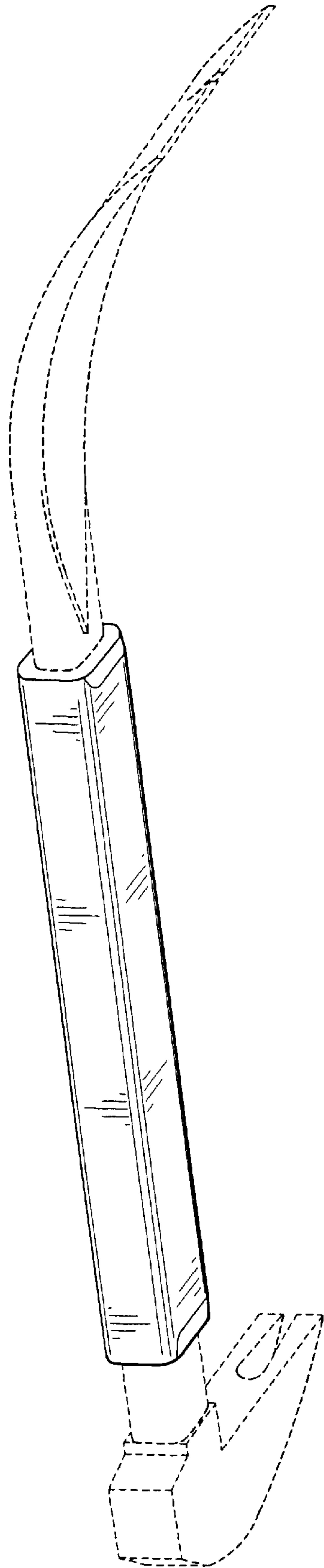

FIG. 9

FIG. 10

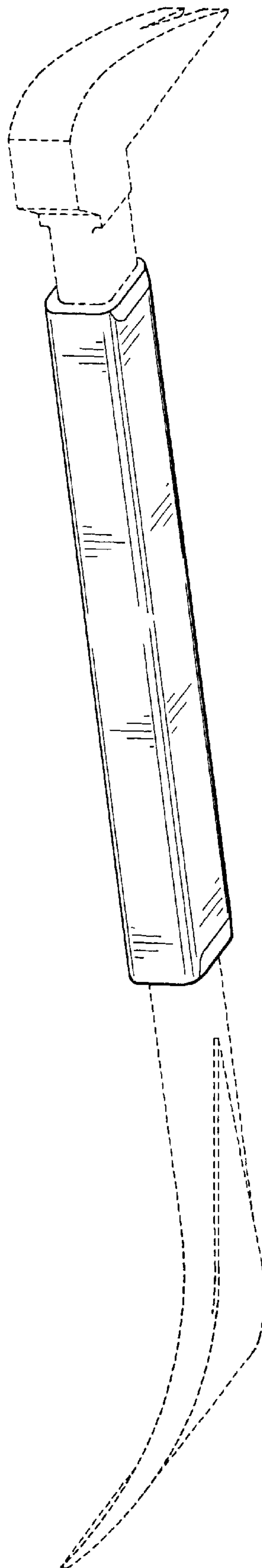

FIG.11

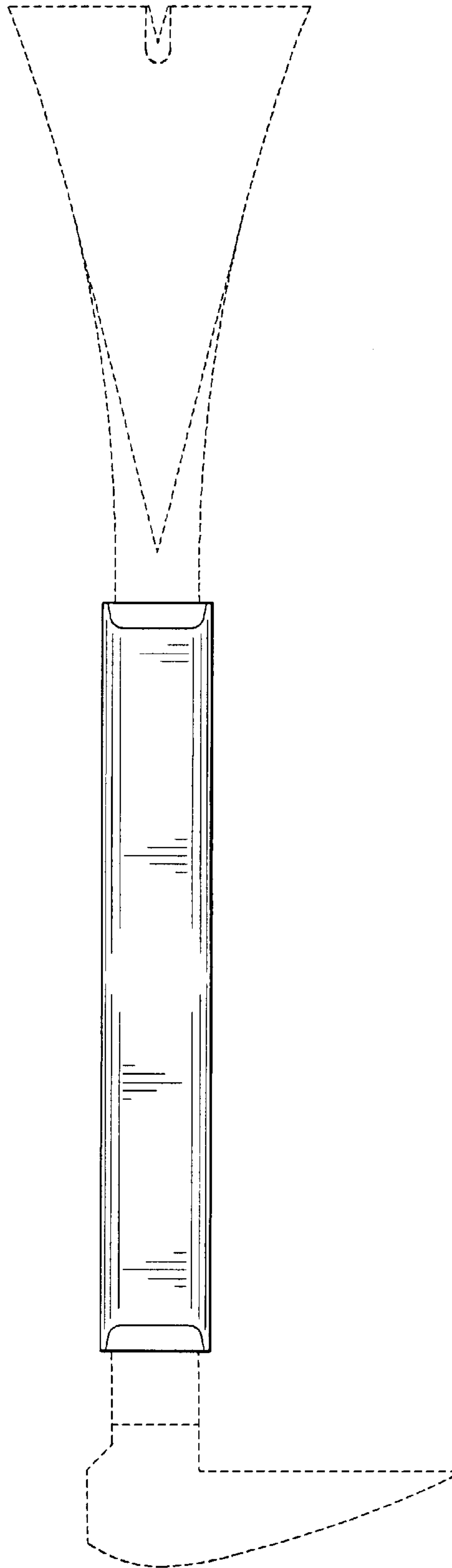

FIG.12

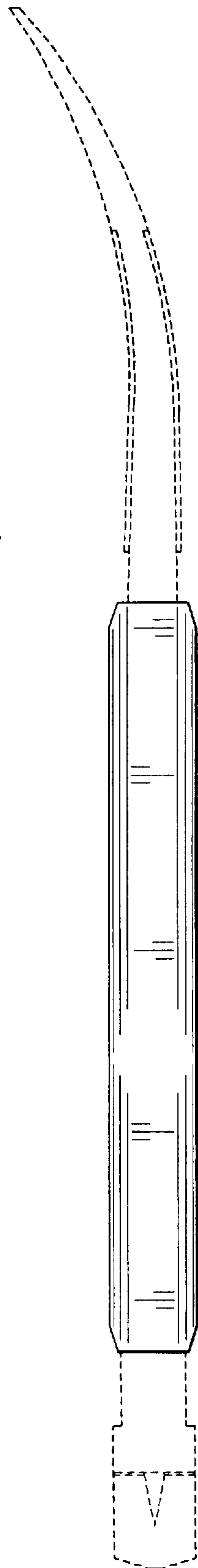

FIG.13

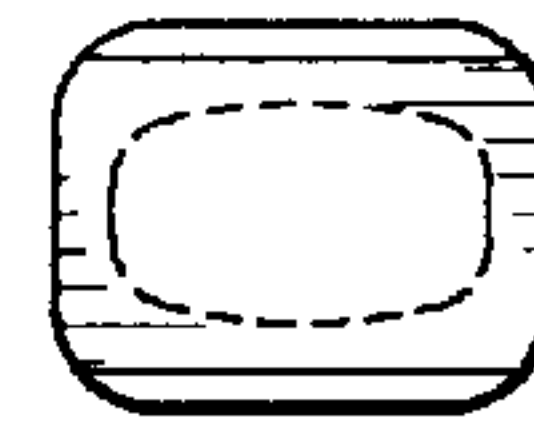
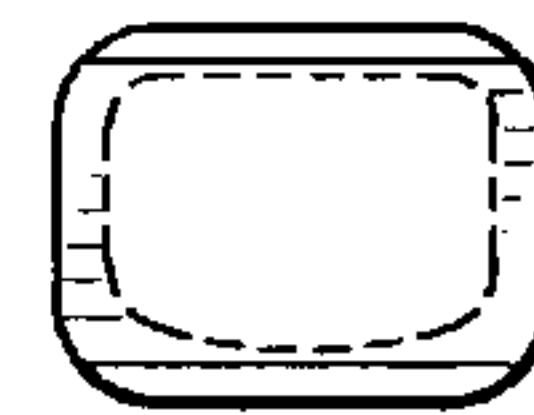

FIG.14



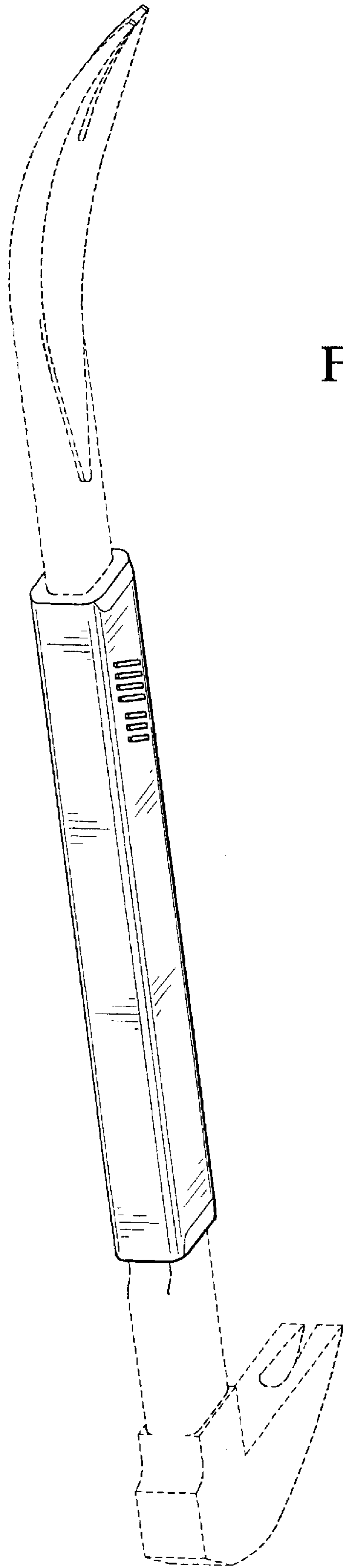

FIG.15

FIG.16

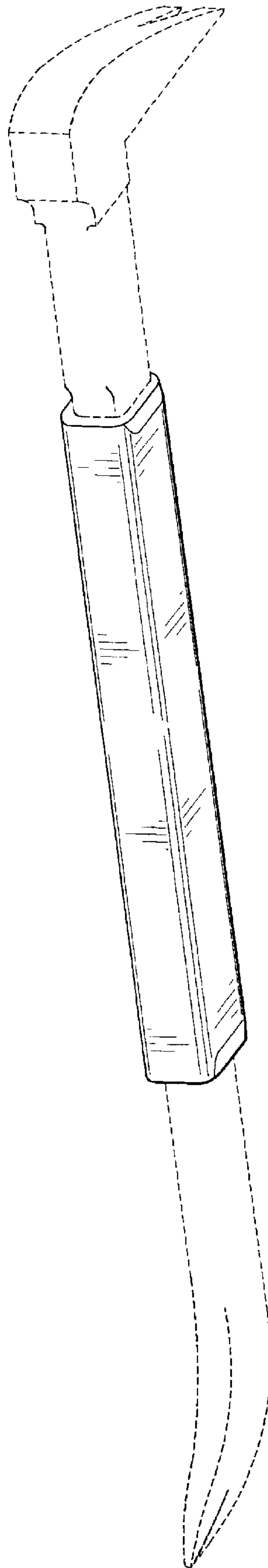

FIG.17

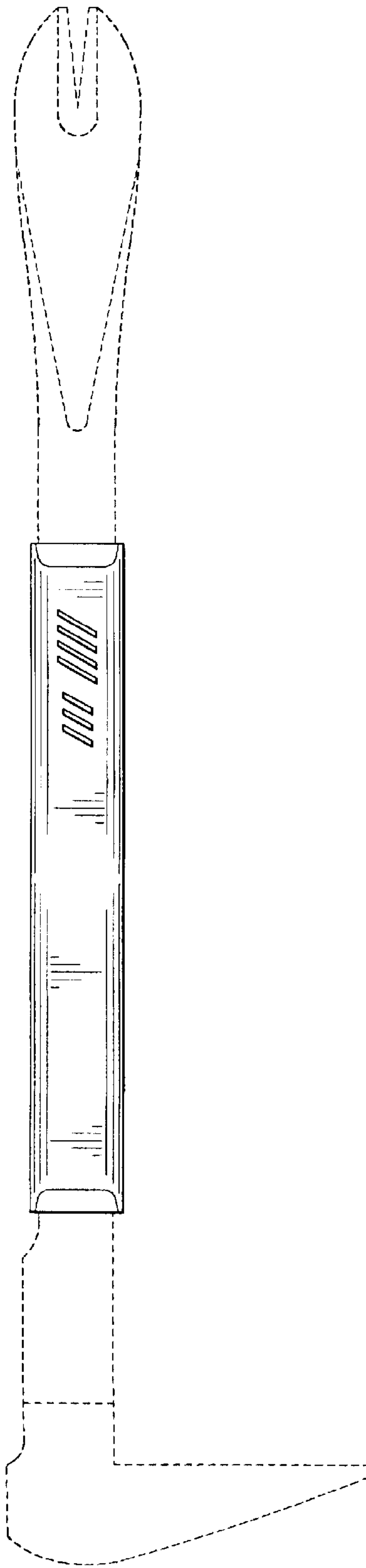

FIG.18

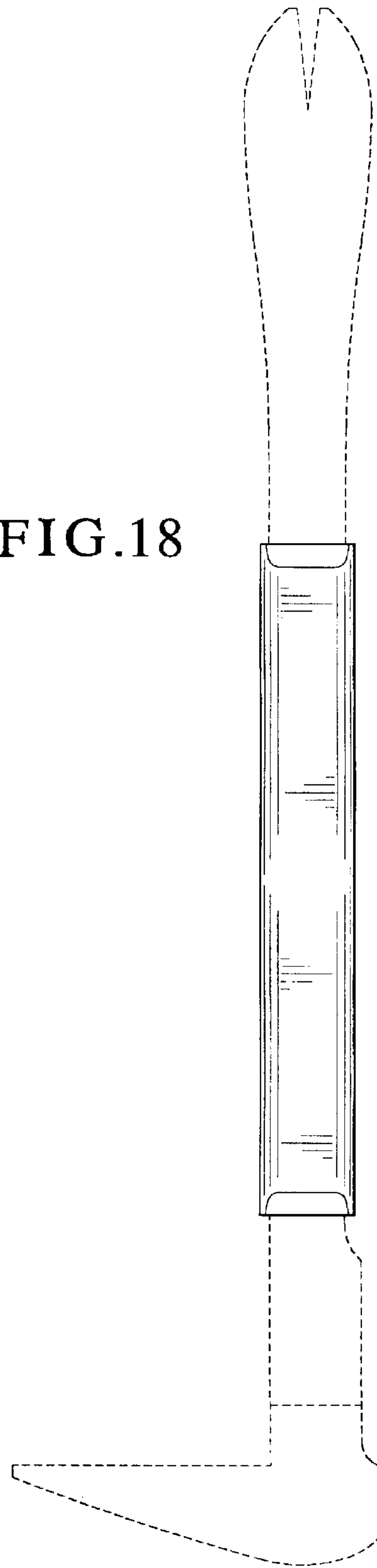

FIG.19

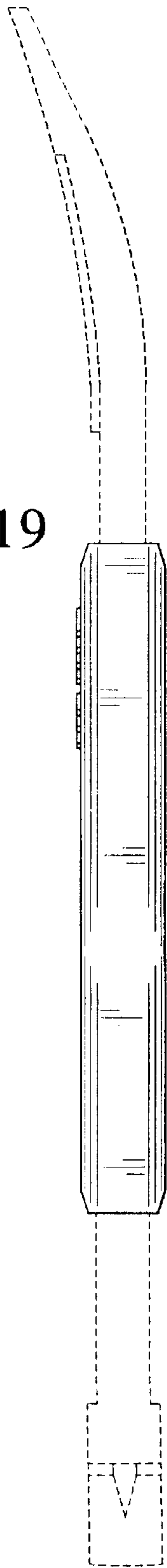

FIG.20

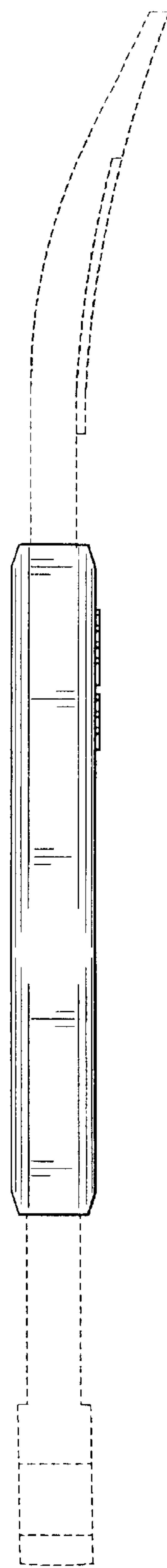

FIG.21

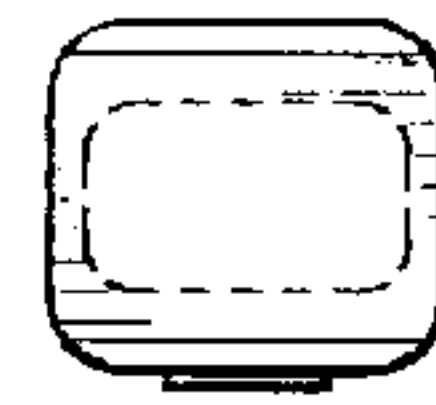
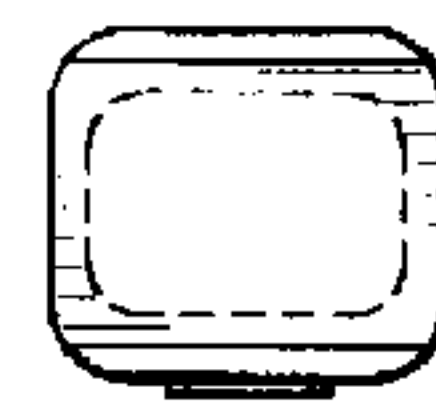

FIG.22



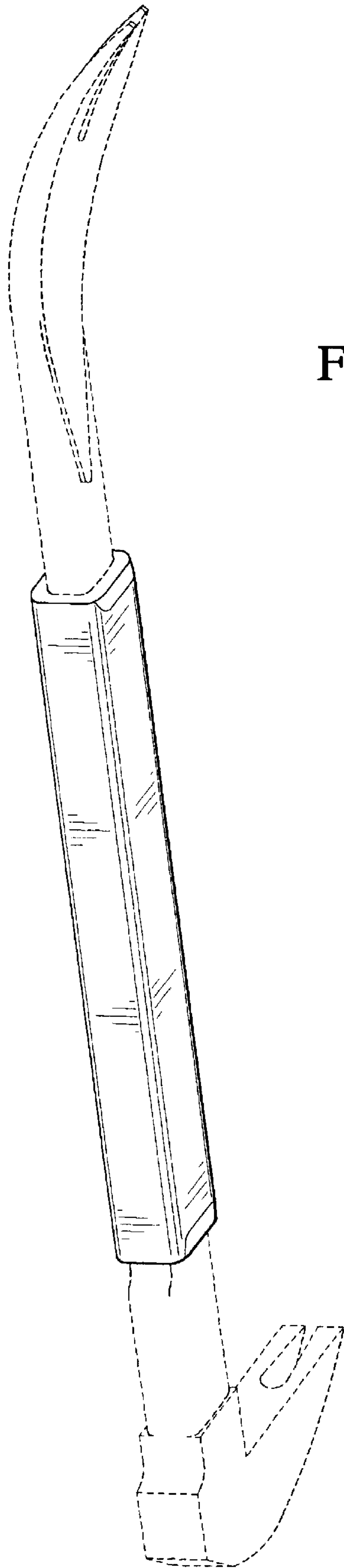

FIG. 23

FIG. 24

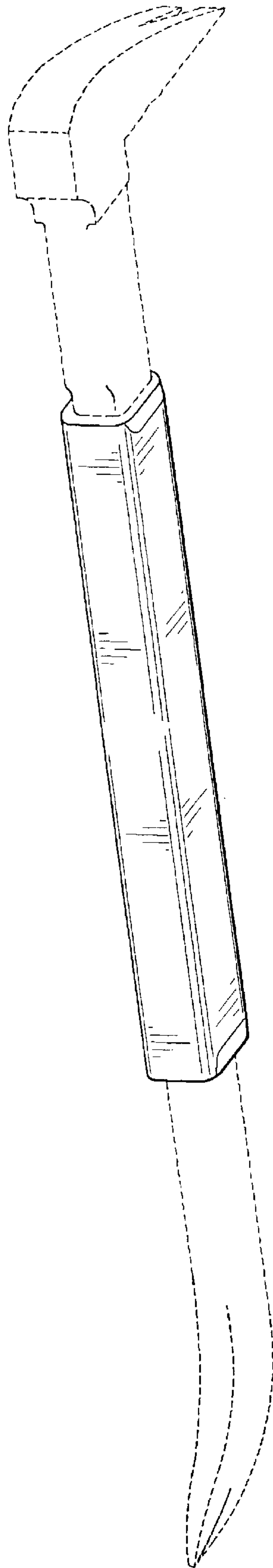

FIG. 25

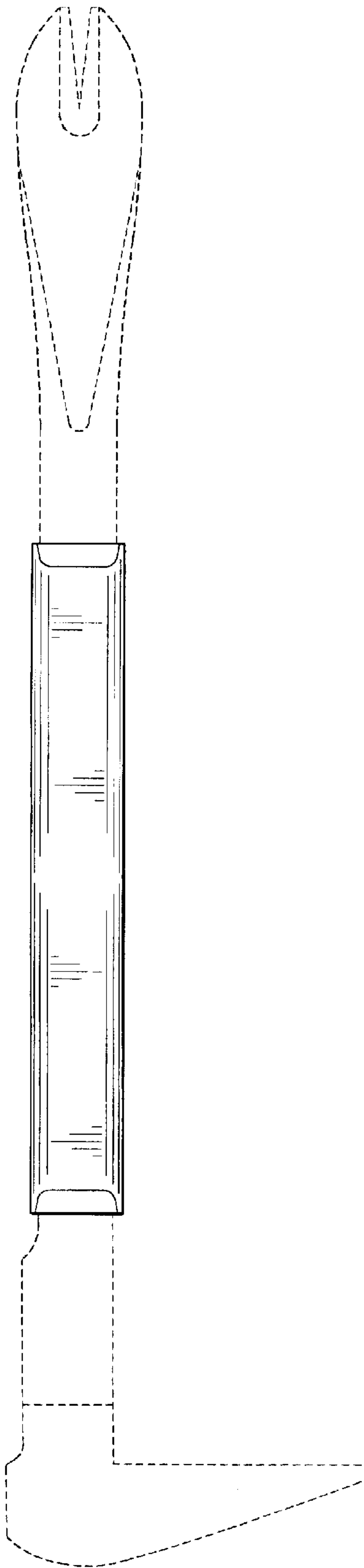

FIG. 26

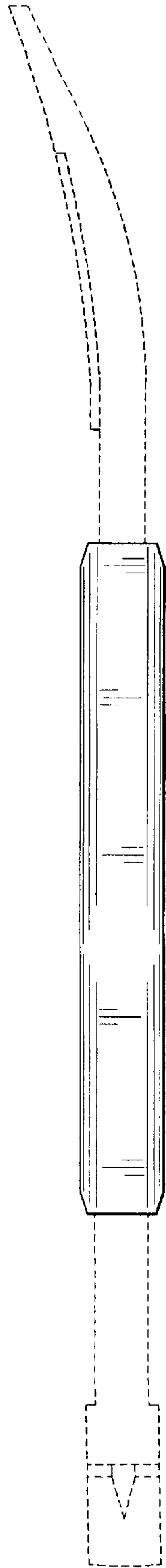

FIG. 27

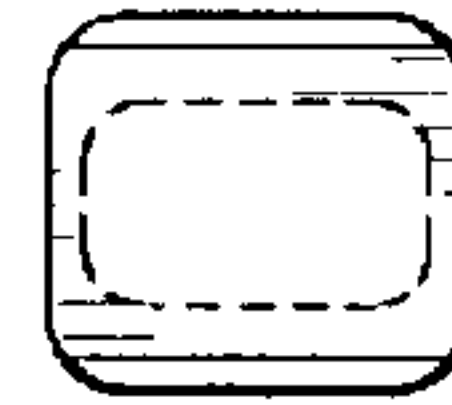

FIG. 28

