



US00D539612S

(12) **United States Design Patent** (10) **Patent No.:** **US D539,612 S**  
**Foss** (45) **Date of Patent:** **\*\* Apr. 3, 2007**

(54) **FOOD CONTAINER**

(76) Inventor: **Aaron Foss**, 15 Gladysz Way, Port Jefferson, NY (US) 11776

(\*\*) Term: **14 Years**

(21) Appl. No.: **29/242,040**

(22) Filed: **Nov. 4, 2005**

(51) **LOC (8) Cl.** ..... **07-01**

(52) **U.S. Cl.** ..... **D7/629; D9/428**

(58) **Field of Classification Search** ..... D7/602,  
D7/629, 538-542; D9/414, 424-432; 220/787-805;  
D3/201, 203.1, 205, 206, 273, 302  
See application file for complete search history.

(56) **References Cited**

**U.S. PATENT DOCUMENTS**

D224,585 S	8/1972	Jewell	
D286,844 S	11/1986	Daenen et al.	
D297,119 S	8/1988	Fontana et al.	
D330,309 S	* 10/1992	Minuti	..... D7/629
D371,940 S	7/1996	Krupa	
D387,272 S	12/1997	Lippincott	
D414,080 S	9/1999	Bolwien	
D414,409 S	9/1999	Sanfilippo et al.	
D420,857 S	2/2000	Loew et al.	
D474,687 S	5/2003	Jones et al.	
D485,473 S	1/2004	Dais et al.	
D486,358 S	2/2004	Dais et al.	
D494,463 S	8/2004	Tsao	
D501,366 S	2/2005	Claypool et al.	
D505,335 S	5/2005	Grenda	

\* cited by examiner

*Primary Examiner*—Terry A. Wallace  
(74) *Attorney, Agent, or Firm*—Wiggin and Dana LLP;  
Elizabeth A. Galletta

(57) **CLAIM**

What is claimed is, the ornamental design for a food container, as shown and described.

**DESCRIPTION**

FIG. 1 is a perspective view of a top, front, and right side of an ornamental design for a container and lid according to the present invention;  
FIG. 2 is a top plan view of the container and lid of FIG. 1;  
FIG. 3 is a right side elevational view of the container and lid of FIG. 1, a left side elevational view being identical thereto;  
FIG. 4 is a front elevational view of the container and lid of FIG. 1, a rear elevational view being identical thereto;  
FIG. 5 is a bottom view of the container and lid of FIG. 1;  
FIG. 6 is a perspective view of a top, front and right side of an ornamental design for a container according to the present invention;  
FIG. 7 is a top plan view of the container of FIG. 6;  
FIG. 8 is a right side elevational view of the container of FIG. 6, a left side elevational view being identical thereto;  
FIG. 9 is a front elevational view of the container of FIG. 6, a rear elevational view being identical thereto;  
FIG. 10 is a bottom view of the container of FIG. 6;  
FIG. 11 is a perspective view of a top, front and right side of an ornamental design for a lid according to the present invention;  
FIG. 12 is a top plan view of the lid of FIG. 11;  
FIG. 13 is a right side elevational view of the lid of FIG. 11, a left side elevational view being identical thereto;  
FIG. 14 is a front elevational view of the lid of FIG. 11, a rear elevational view being identical thereto; and,  
FIG. 15 is a bottom view of the lid of FIG. 11.  
The container and lid are shown separately for clarity of illustration.

**1 Claim, 6 Drawing Sheets**

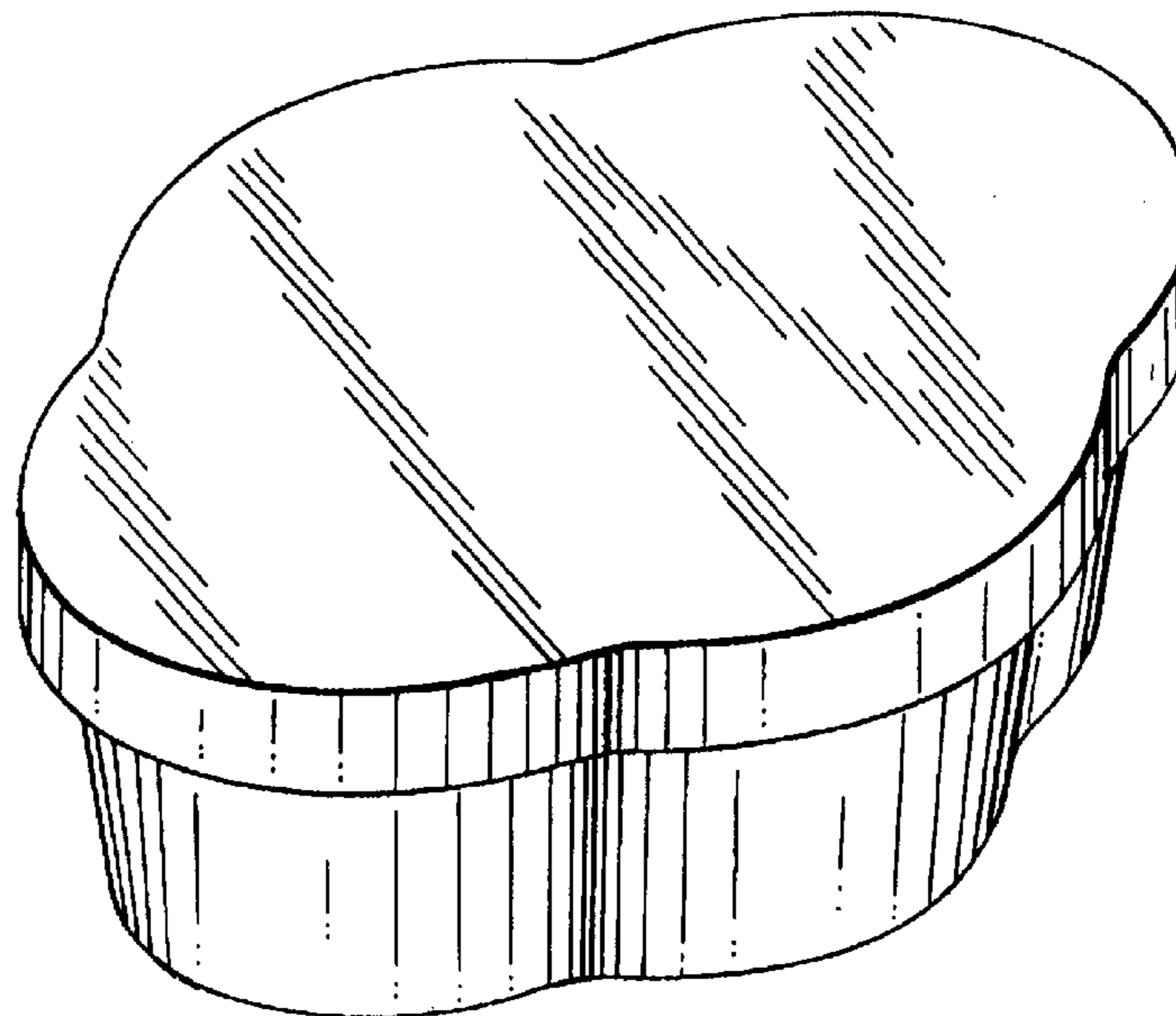

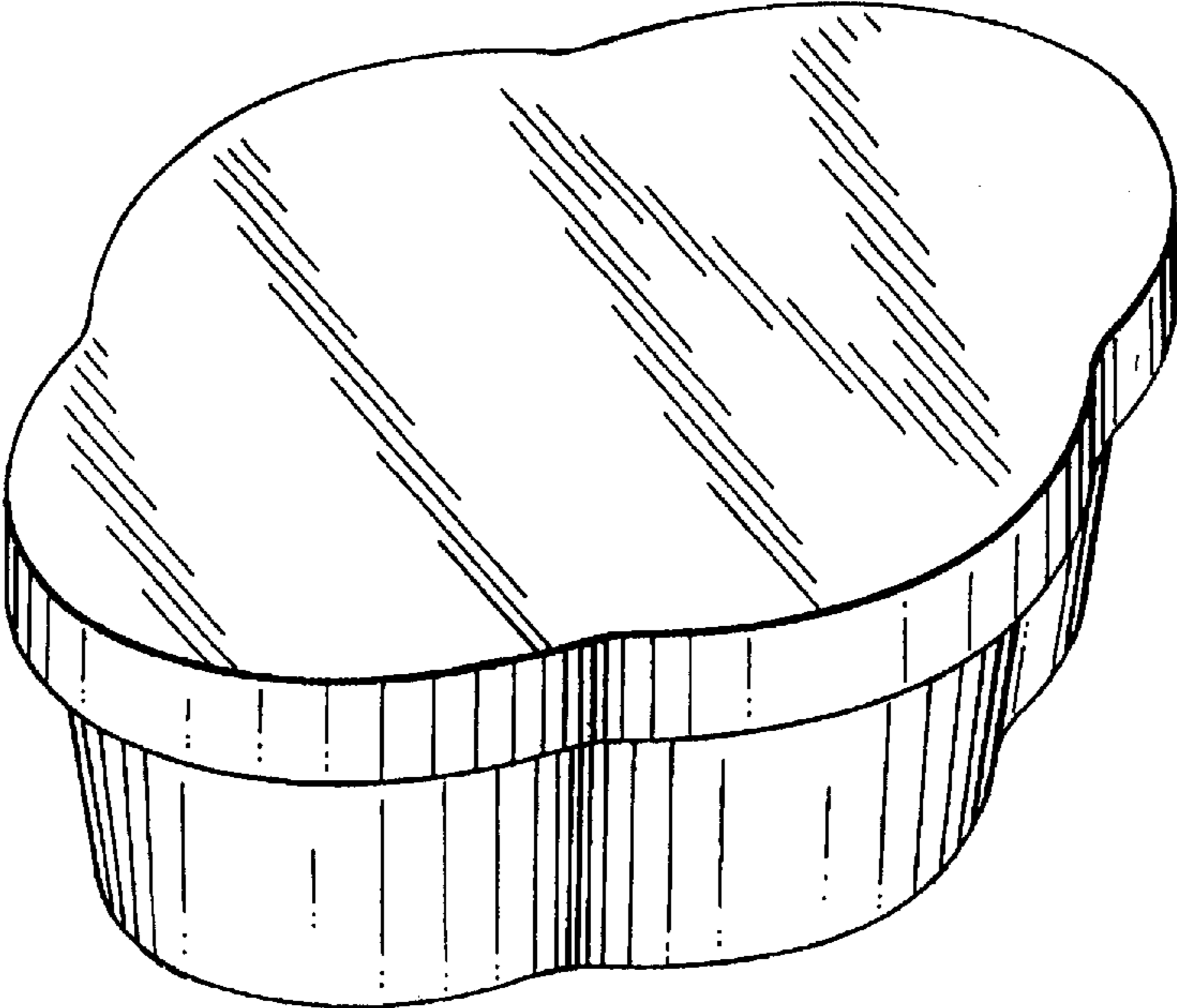

FIG. 1

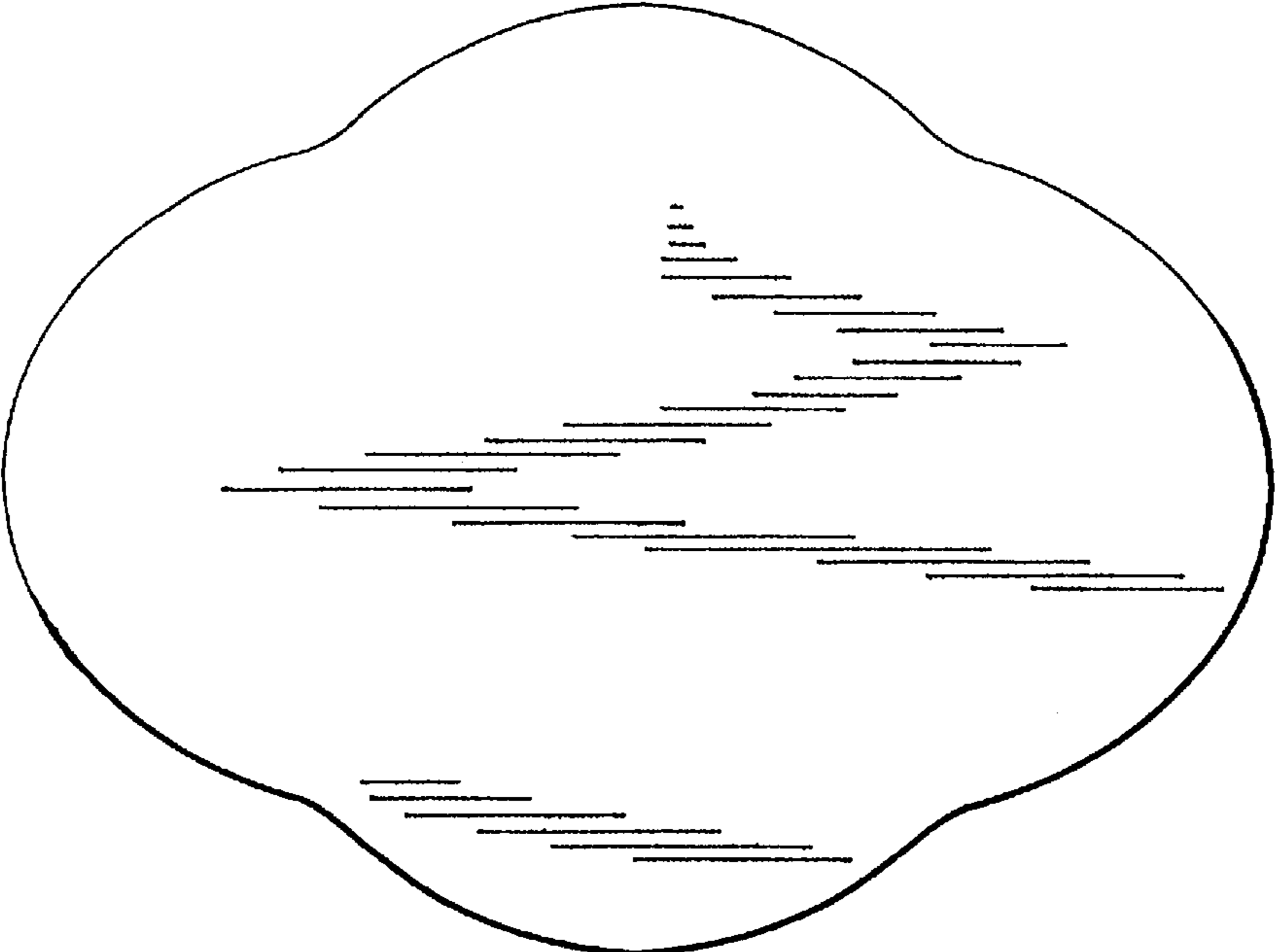

FIG. 2

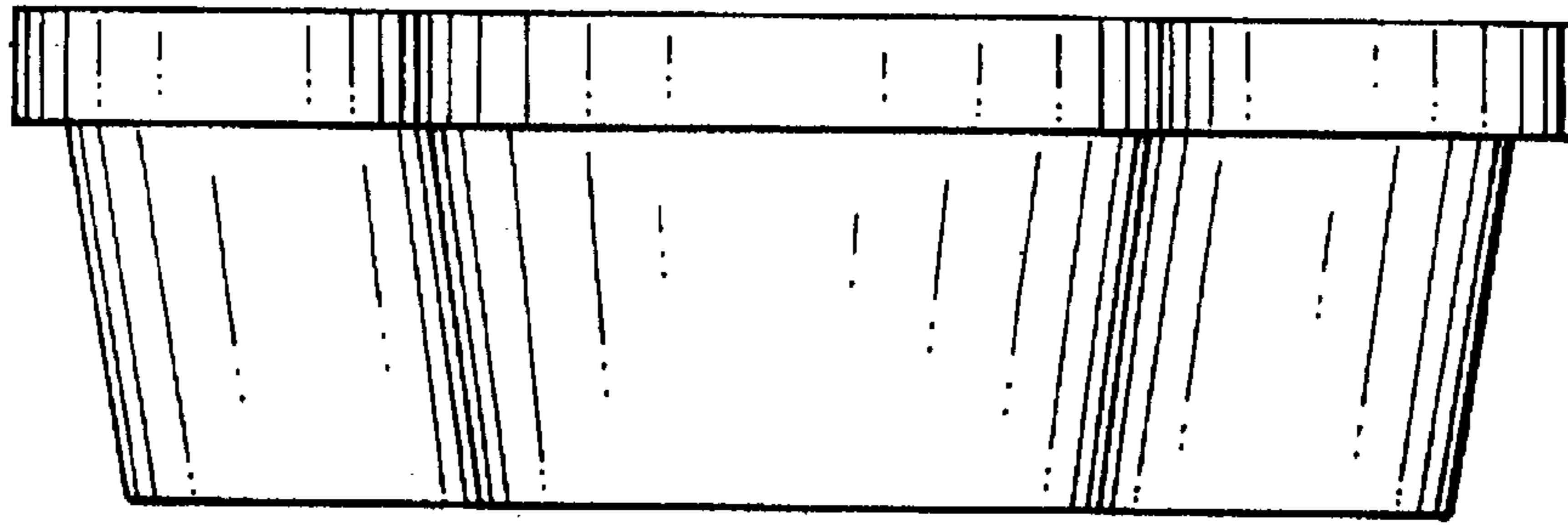

FIG. 3

FIG. 4

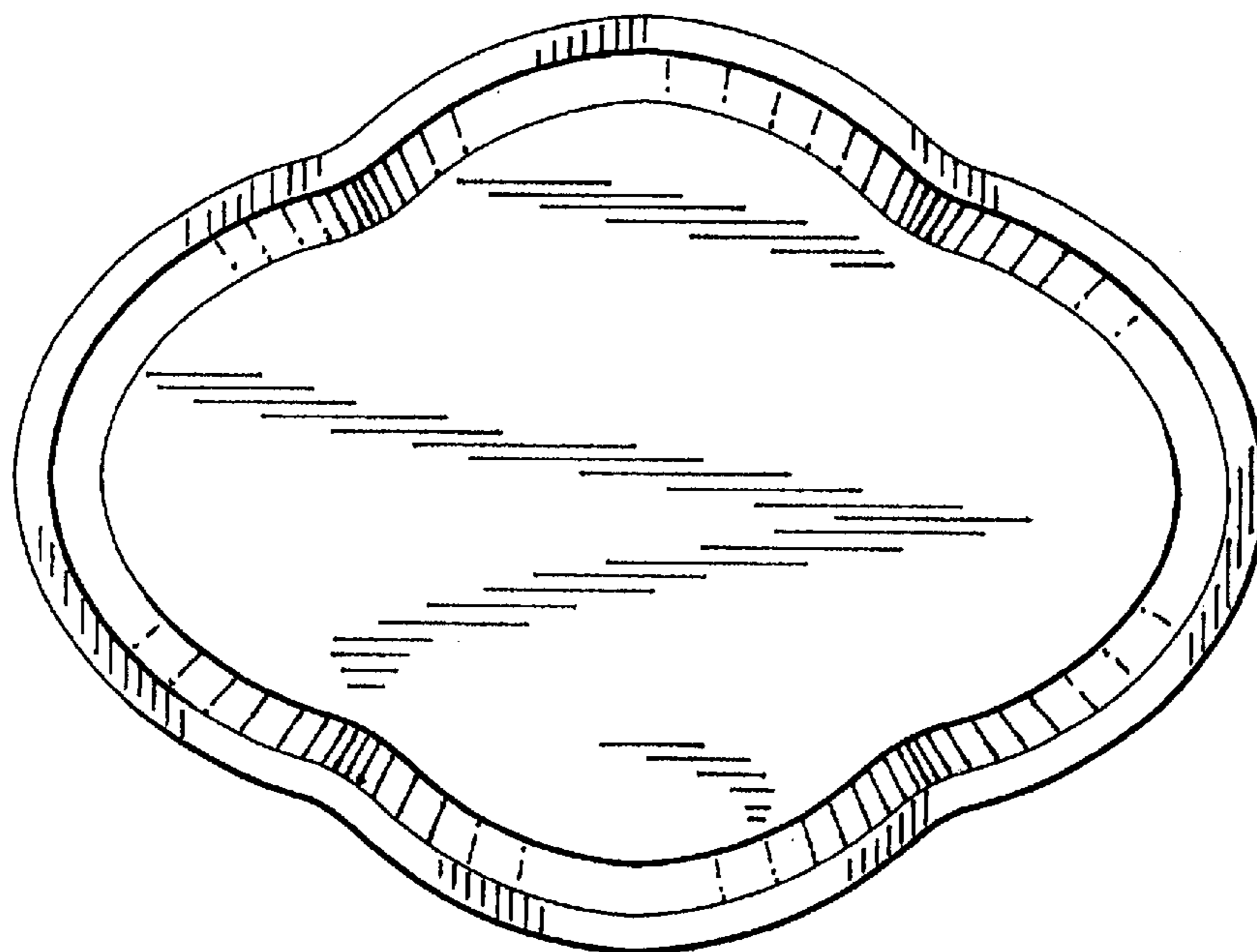
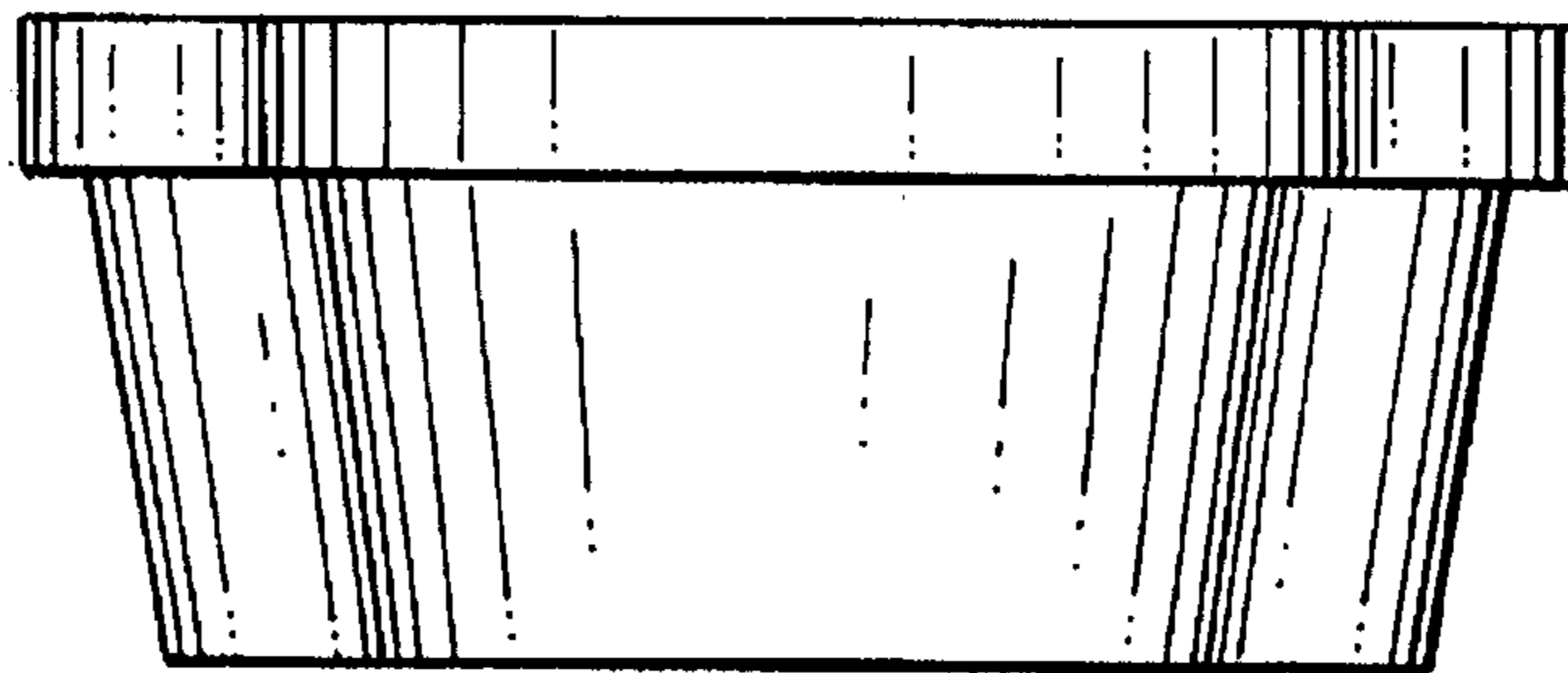

FIG. 5

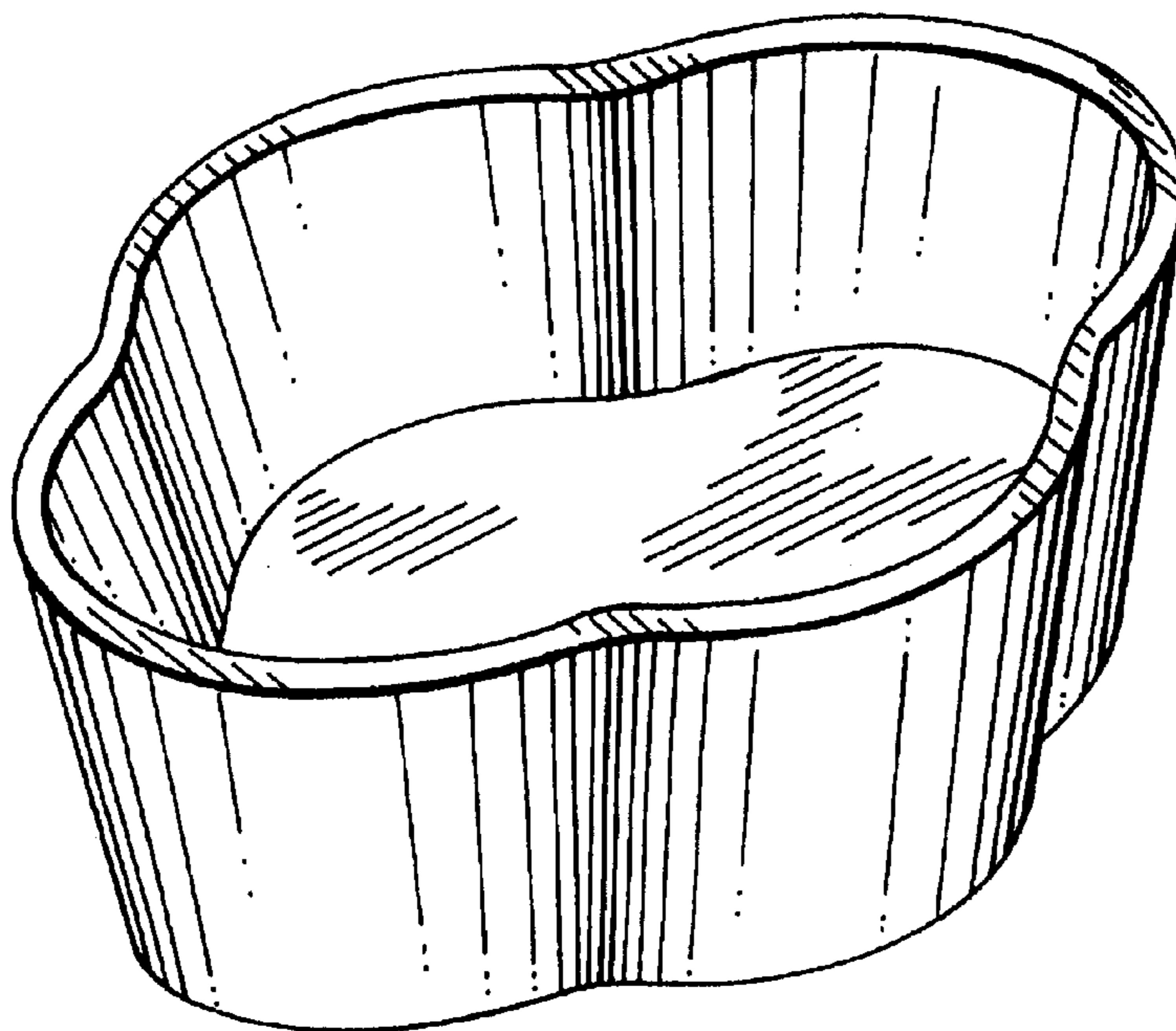

FIG. 6

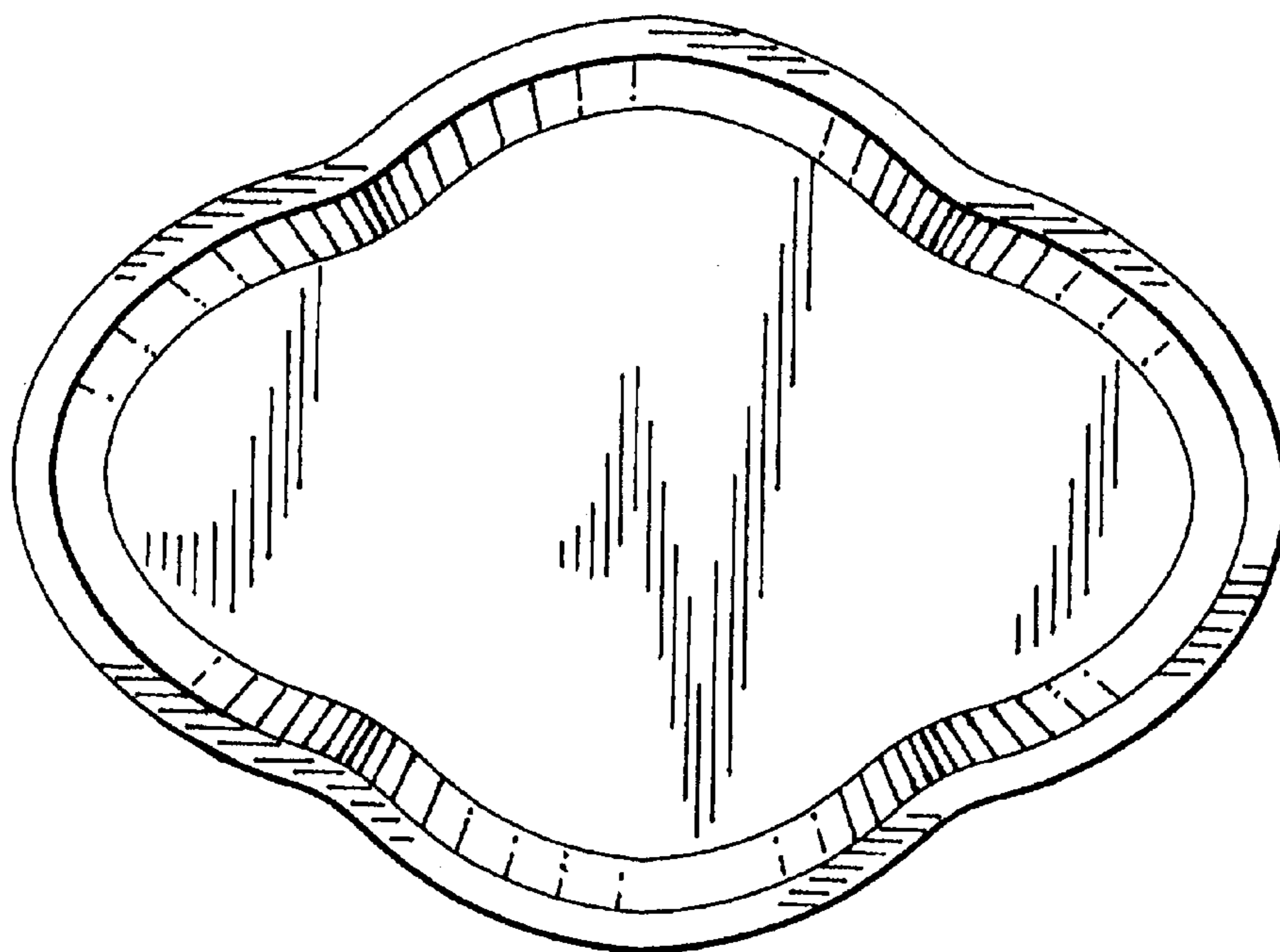

FIG. 7

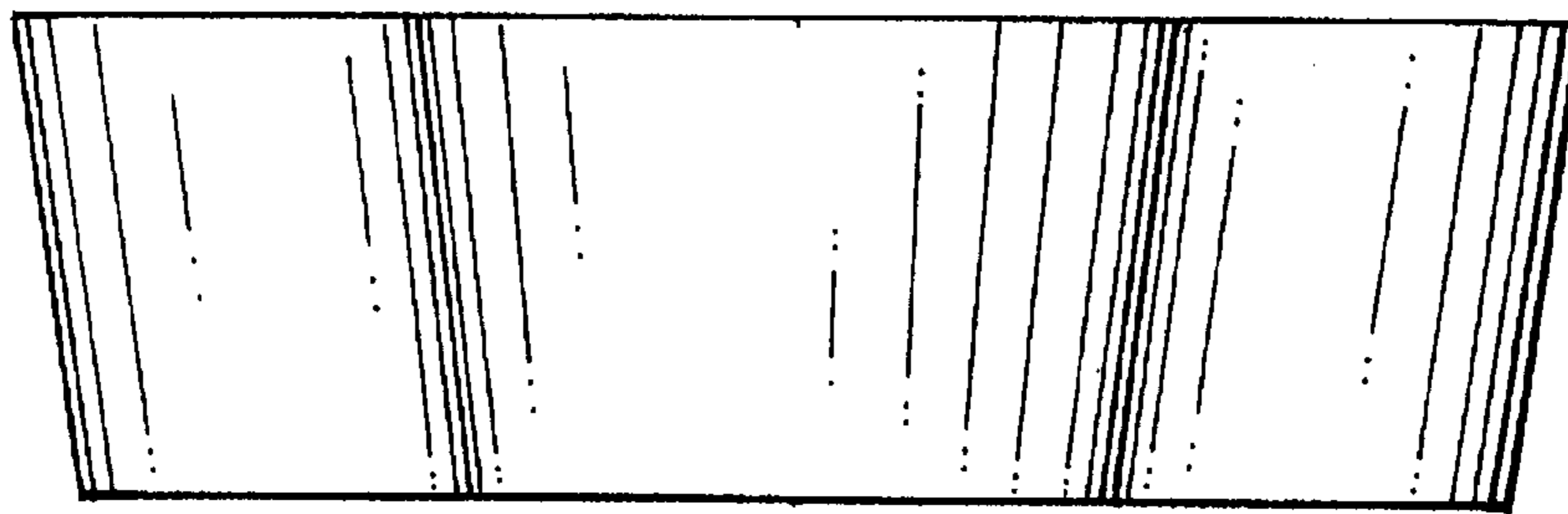

FIG. 8

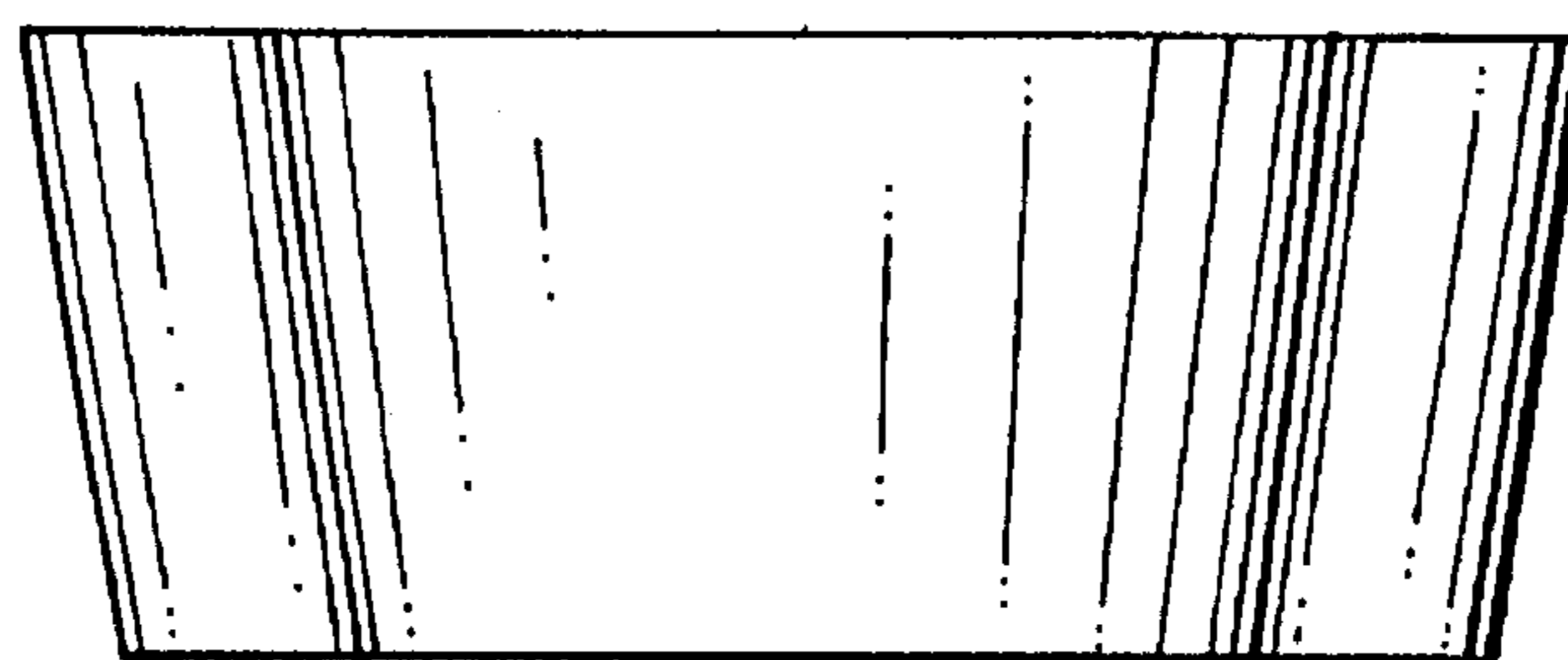

FIG. 9

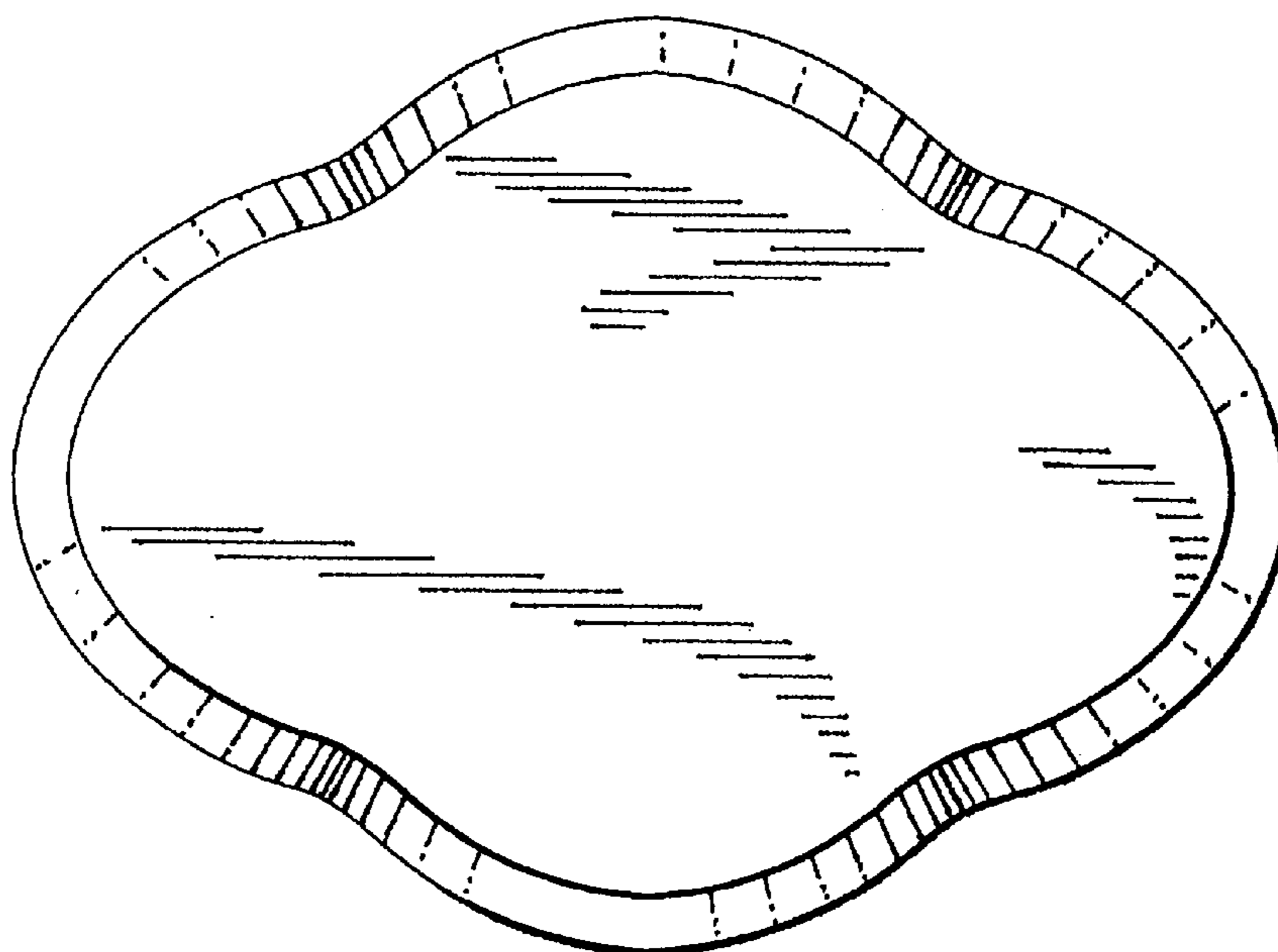

FIG. 10

FIG. 11

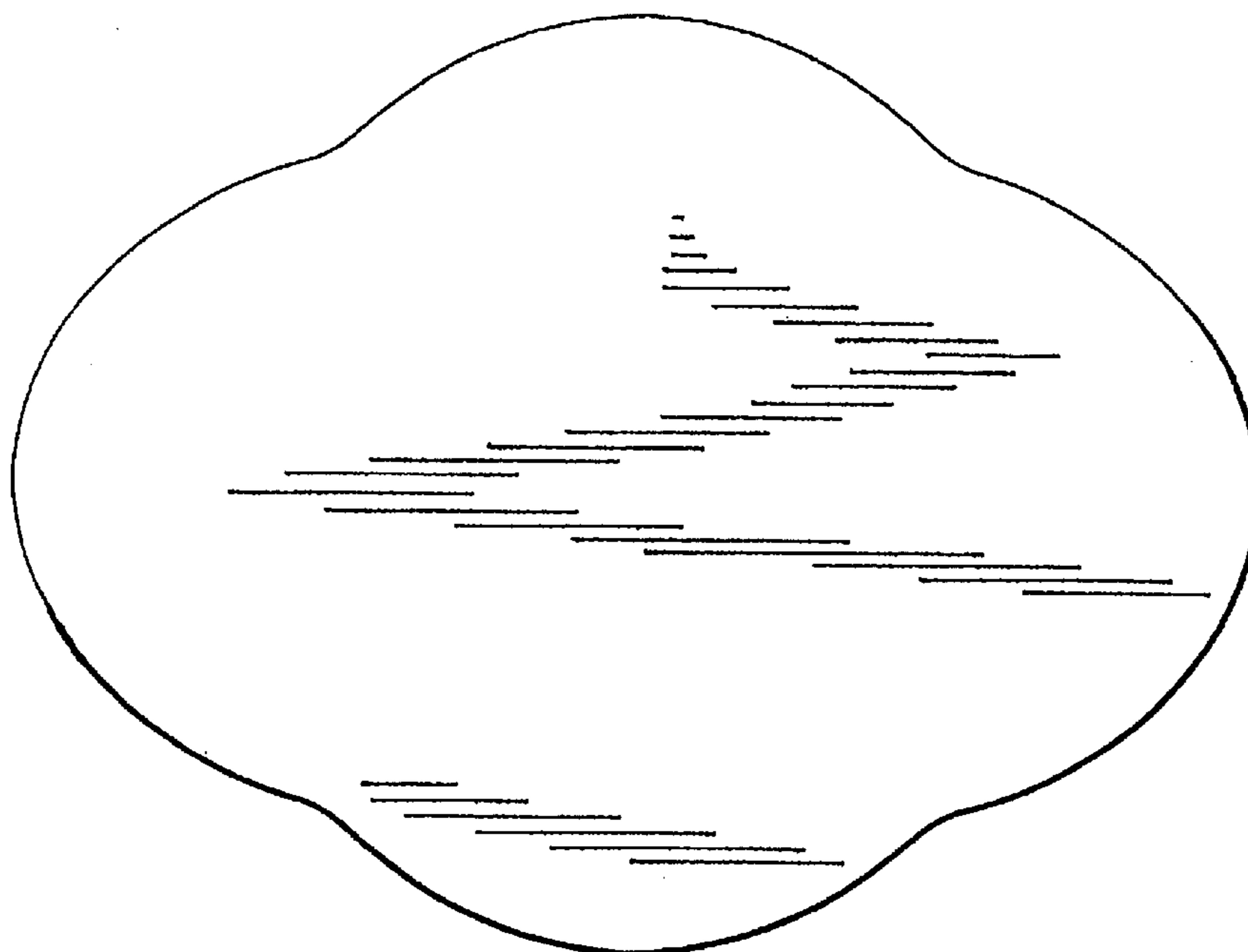
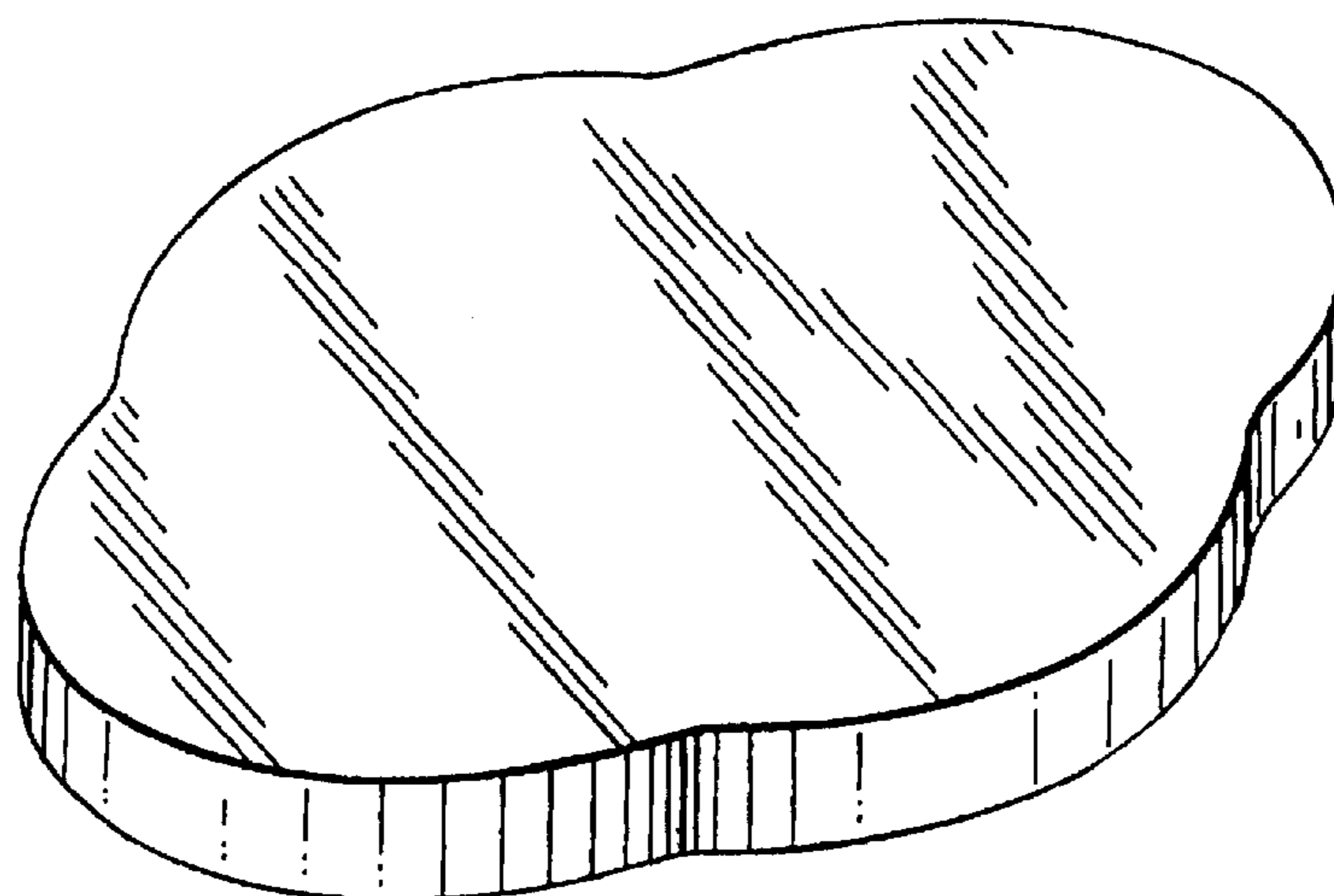

FIG. 12



FIG. 13

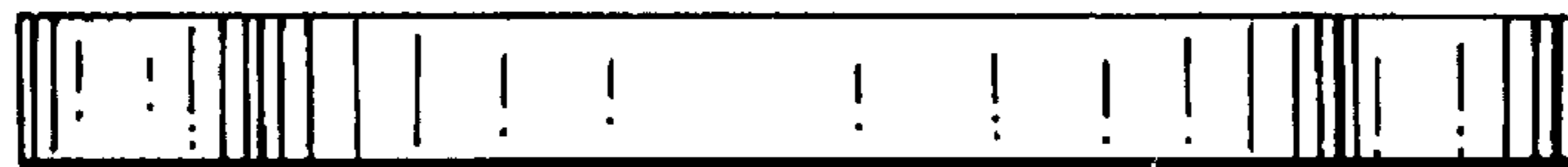

FIG. 14

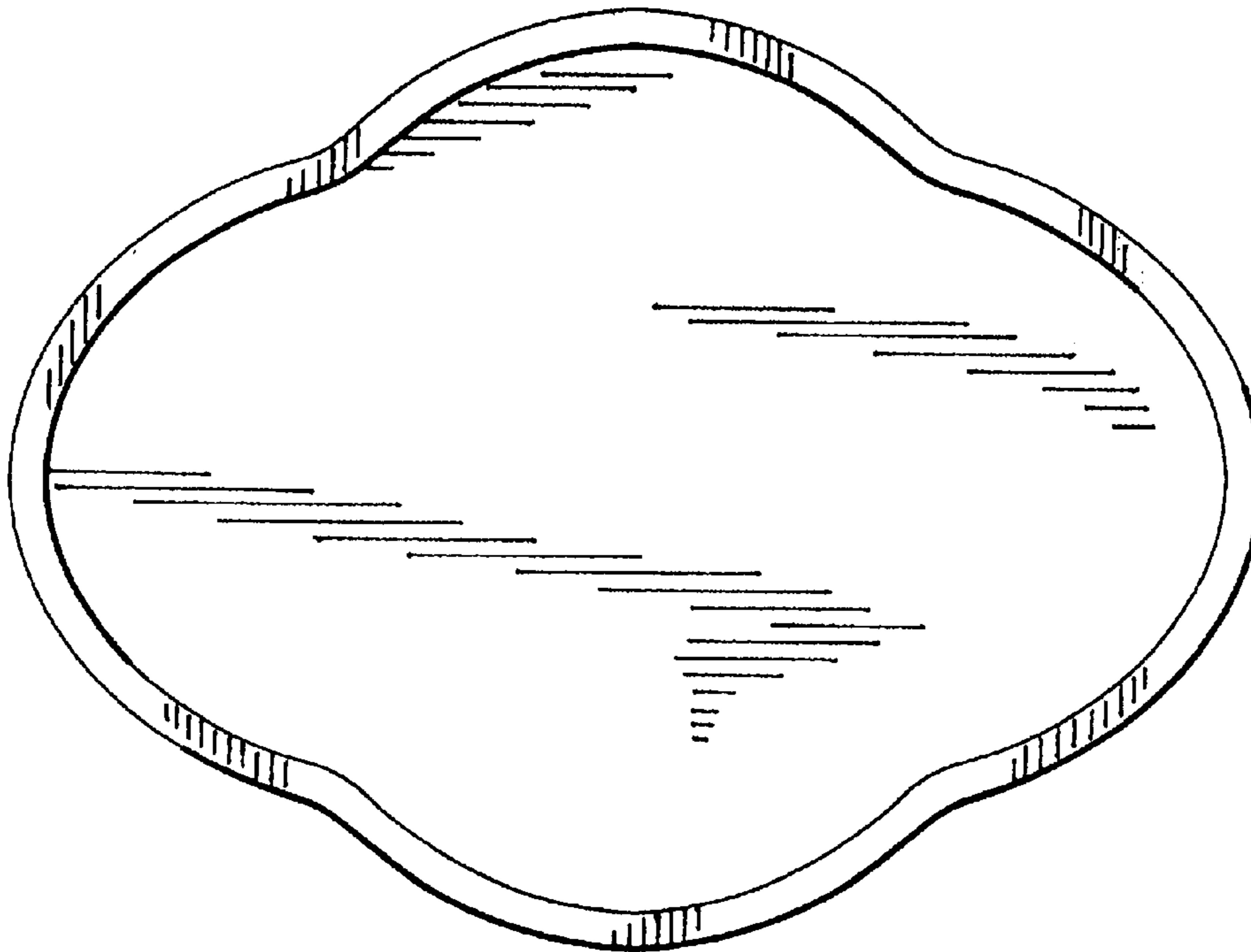

FIG. 15