



US00D539582S

(12) **United States Design Patent** (10) **Patent No.:** **US D539,582 S**
Starck et al. (45) **Date of Patent:** **** Apr. 3, 2007**

(54) **TOOTHBRUSH SANITIZER**

(75) Inventors: **Philippe Starck**, 27 rue Pierre POLI,
Issy les Moulineaux (FR), 92130; **Joel Pinsky**, New York, NY (US)

(73) Assignee: **Philippe Starck**, Issey les Moulineaux (FR)

(**) Term: **14 Years**

(21) Appl. No.: **29/252,051**

(22) Filed: **Jan. 18, 2006**

Related U.S. Application Data

(60) Division of application No. 29/186,588, filed on Jul. 21, 2003, and a continuation-in-part of application No. 10/622,788, filed on Jul. 21, 2003.

(51) **LOC (8) Cl.** **23-02**

(52) **U.S. Cl.** **D6/534**

(58) **Field of Classification Search** D6/524,
D6/534, 526–528; 206/208–209, 209.1, 228,
206/361, 362, 362.1, 362.2, 362.3; 211/13.1,
211/65–66, 70.6

See application file for complete search history.

(56) **References Cited**

U.S. PATENT DOCUMENTS

D286,349 S	*	10/1986	Bussell	D6/534
4,978,003 A	*	12/1990	Foster	206/361
D324,792 S	*	3/1992	McElroy	D6/528
D336,398 S	*	6/1993	Shafer	D6/534
D423,266 S	*	4/2000	Ludwig	D6/534
D439,781 S	*	4/2001	Spore	D6/534
D468,945 S	*	1/2003	Dretzka	D6/534
D478,230 S	*	8/2003	Dretzka	D6/534

D481,572 S * 11/2003 Dretzka D6/534

* cited by examiner

Primary Examiner—Brian N Vinson

(74) *Attorney, Agent, or Firm*—Robert Platt Bell

(57) **CLAIM**

The ornamental design for a toothbrush sanitizer, substantially as shown and described.

DESCRIPTION

FIG. 1 is a front right quarter perspective view of the toothbrush sanitizer of the present invention. The power switch in dashed lines is expressly disclaimed.

FIG. 2 is a rear left quarter perspective view of the toothbrush sanitizer of the present invention. The power plug in dashed lines is expressly disclaimed.

FIG. 3 is a top view of the toothbrush sanitizer of the present invention.

FIG. 4 is a bottom view of the toothbrush sanitizer of the present invention.

FIG. 5 is a front elevational view of the toothbrush sanitizer of the present invention. The power switch in dashed lines is expressly disclaimed.

FIG. 6 is a rear elevational view of the toothbrush sanitizer of the present invention. The power plug switch in dashed lines is expressly disclaimed.

FIG. 7 is a right side elevational view of the toothbrush sanitizer of the present invention. The power plug and power switch in dashed lines is expressly disclaimed.

FIG. 8 is a left side elevational view of the toothbrush sanitizer of the present invention. The power plug and power switch in dashed lines is expressly disclaimed; and,

FIG. 9 is a fifth right quarter perspective view of the toothbrush sanitizer of the present invention illustrating the apparatus in its intended field of use. The toothbrush handles and power switch in dashed lines is expressly disclaimed.

1 Claim, 5 Drawing Sheets

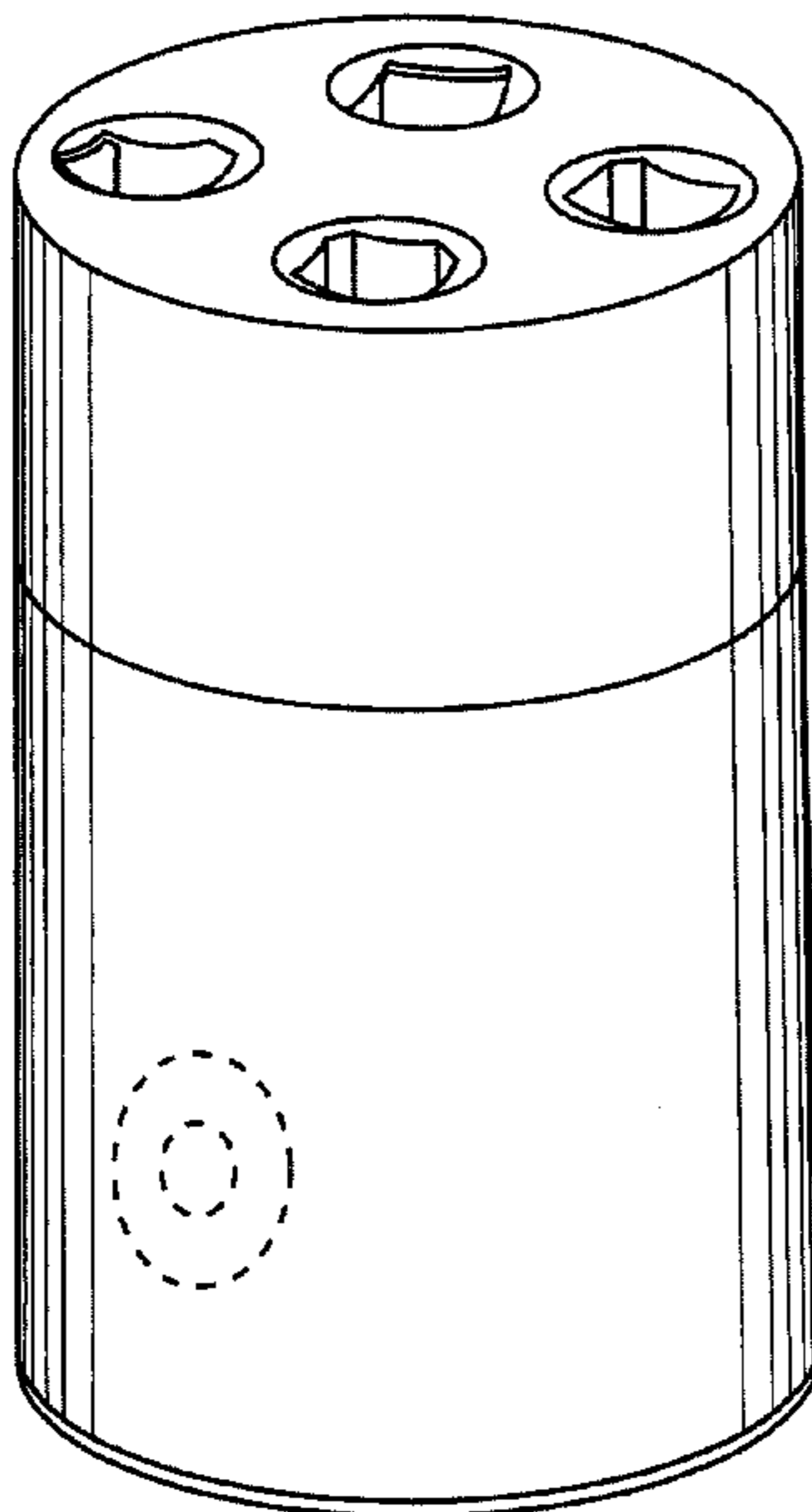

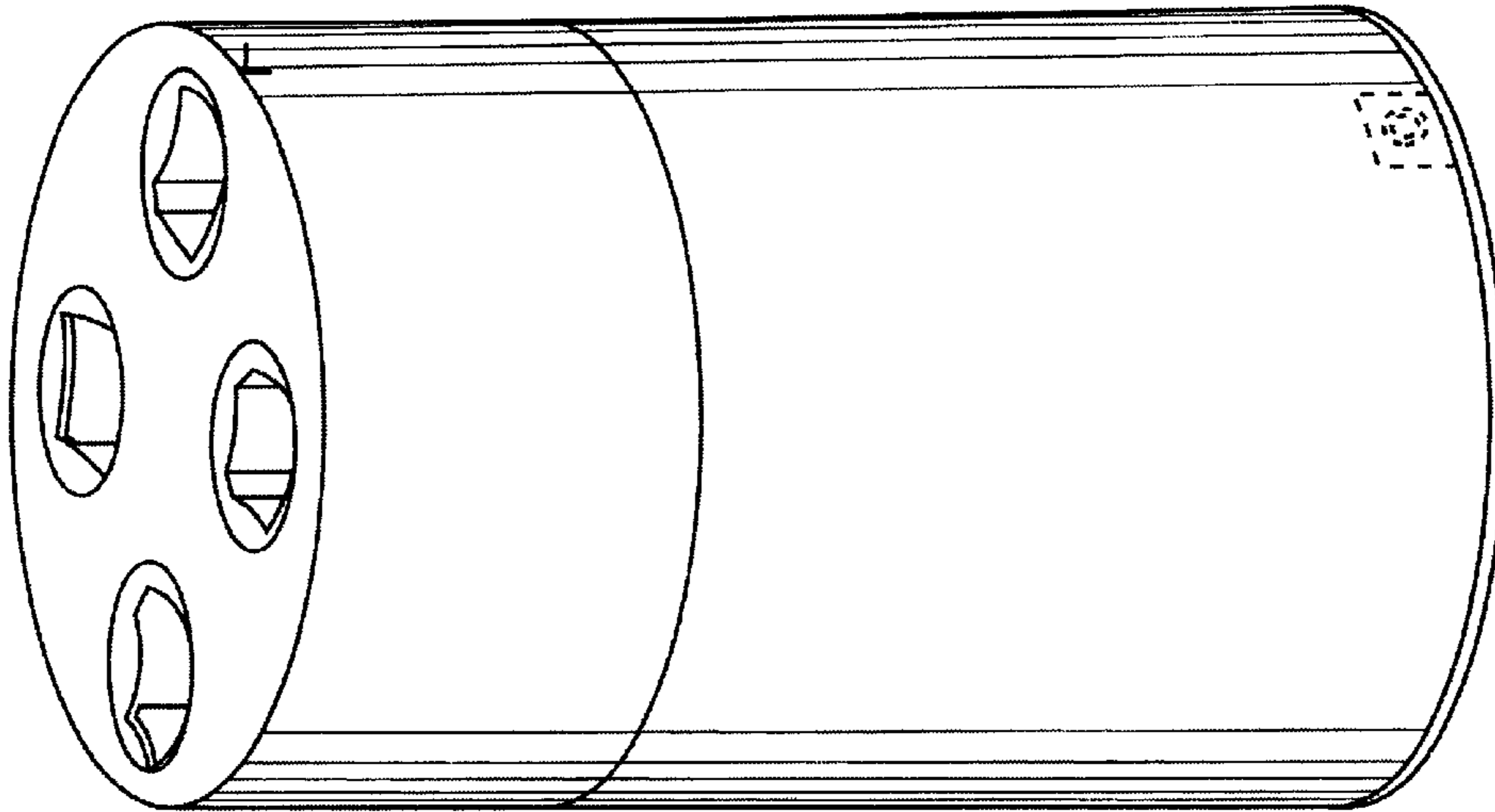

Figure 2

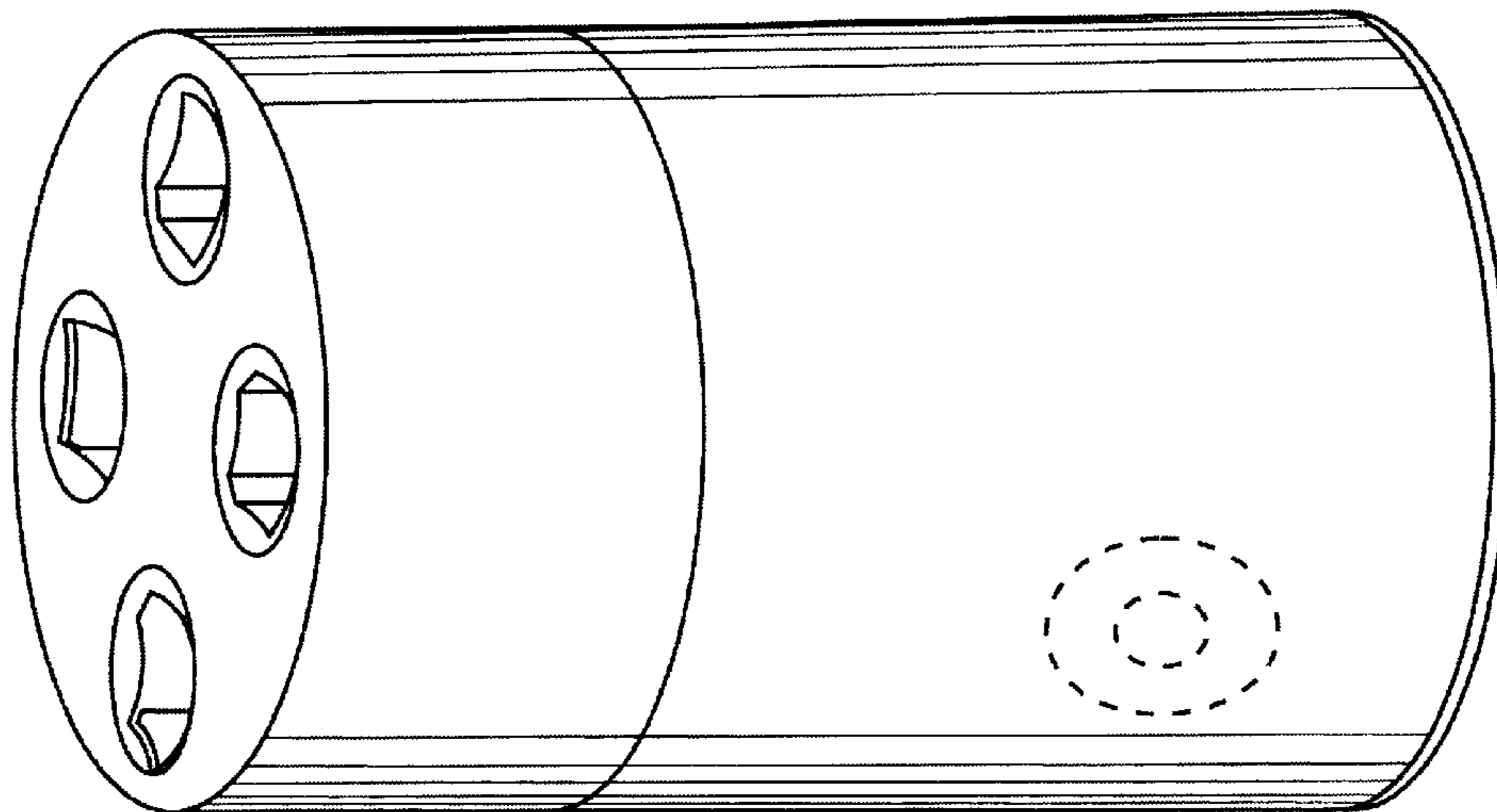

Figure 1

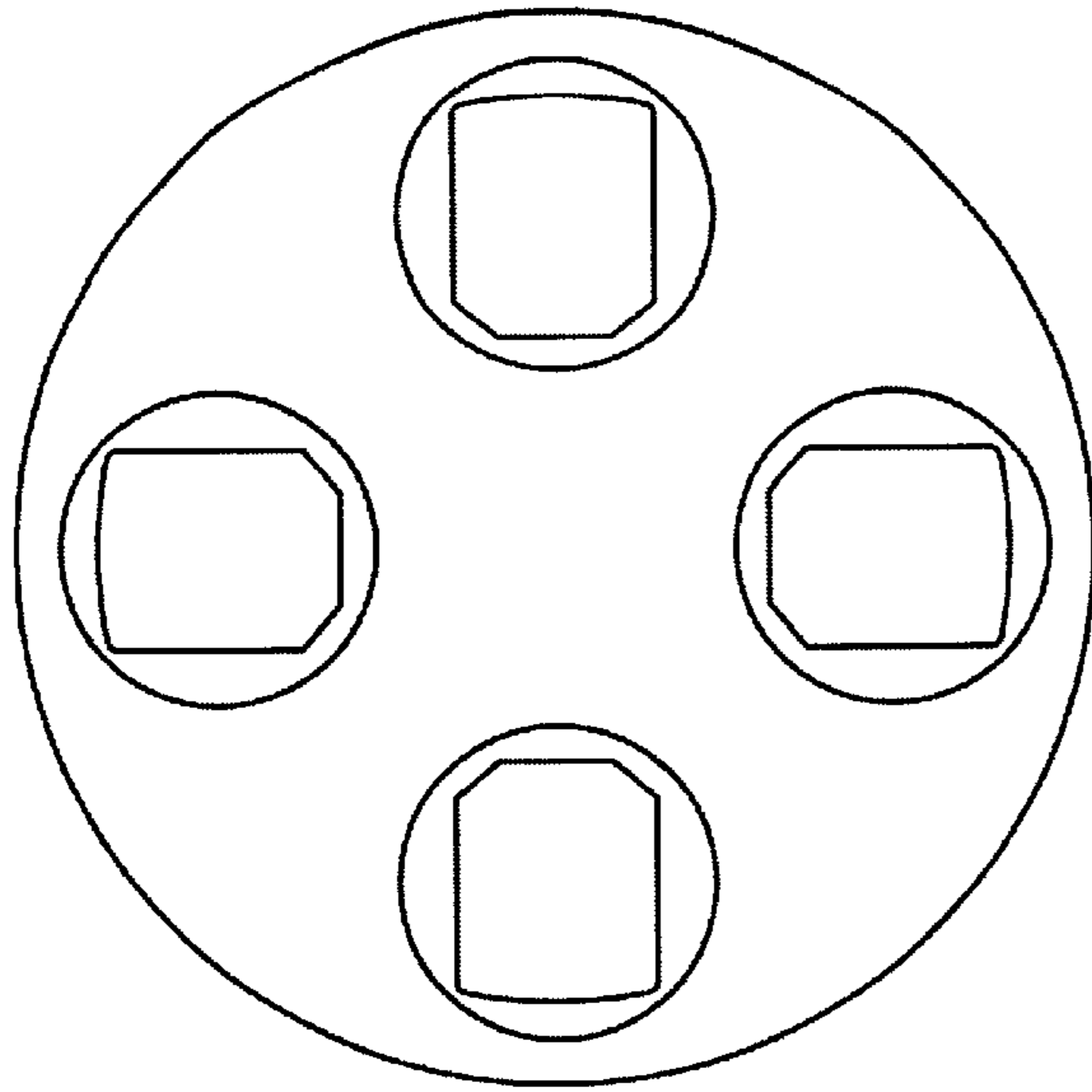

Figure 3

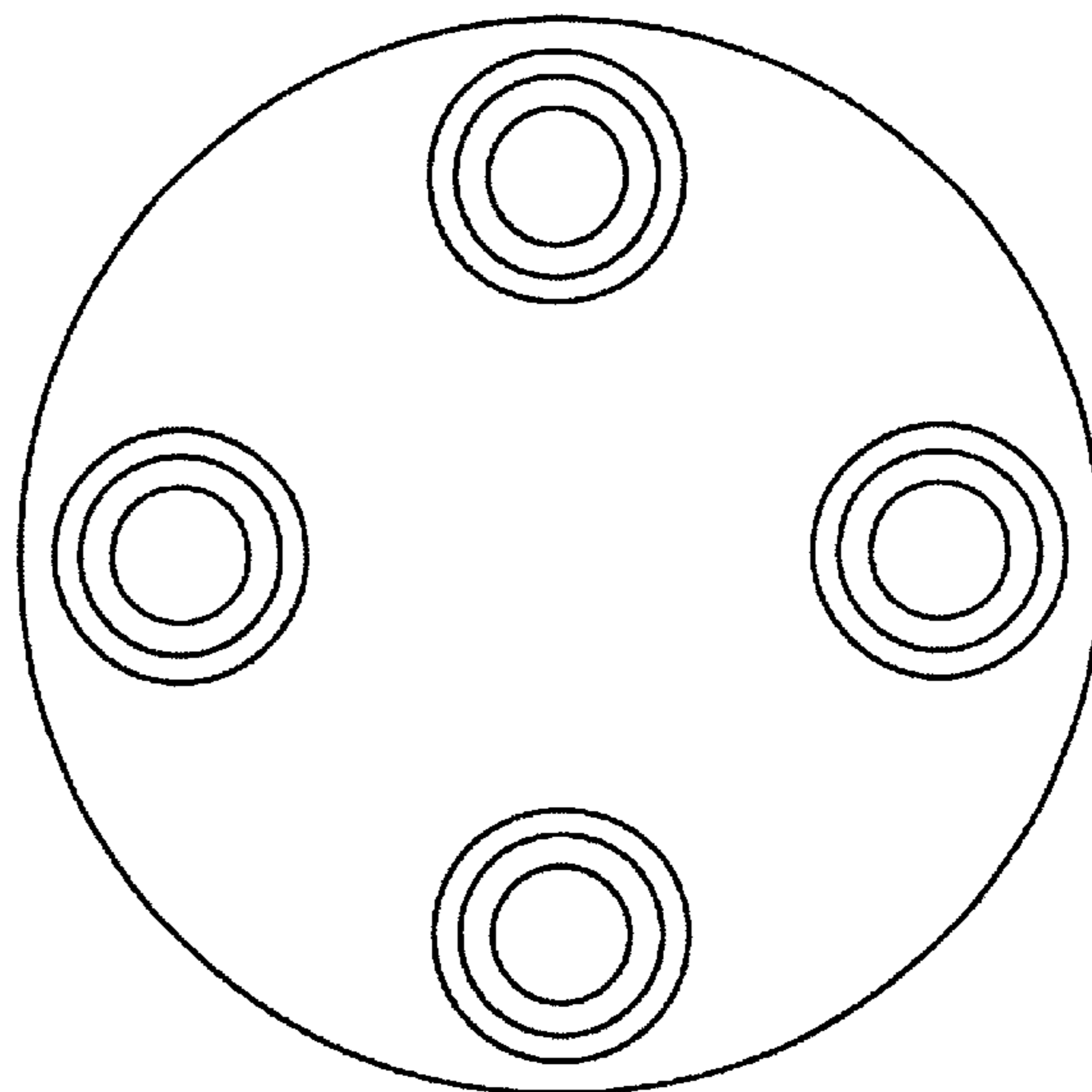

Figure 4

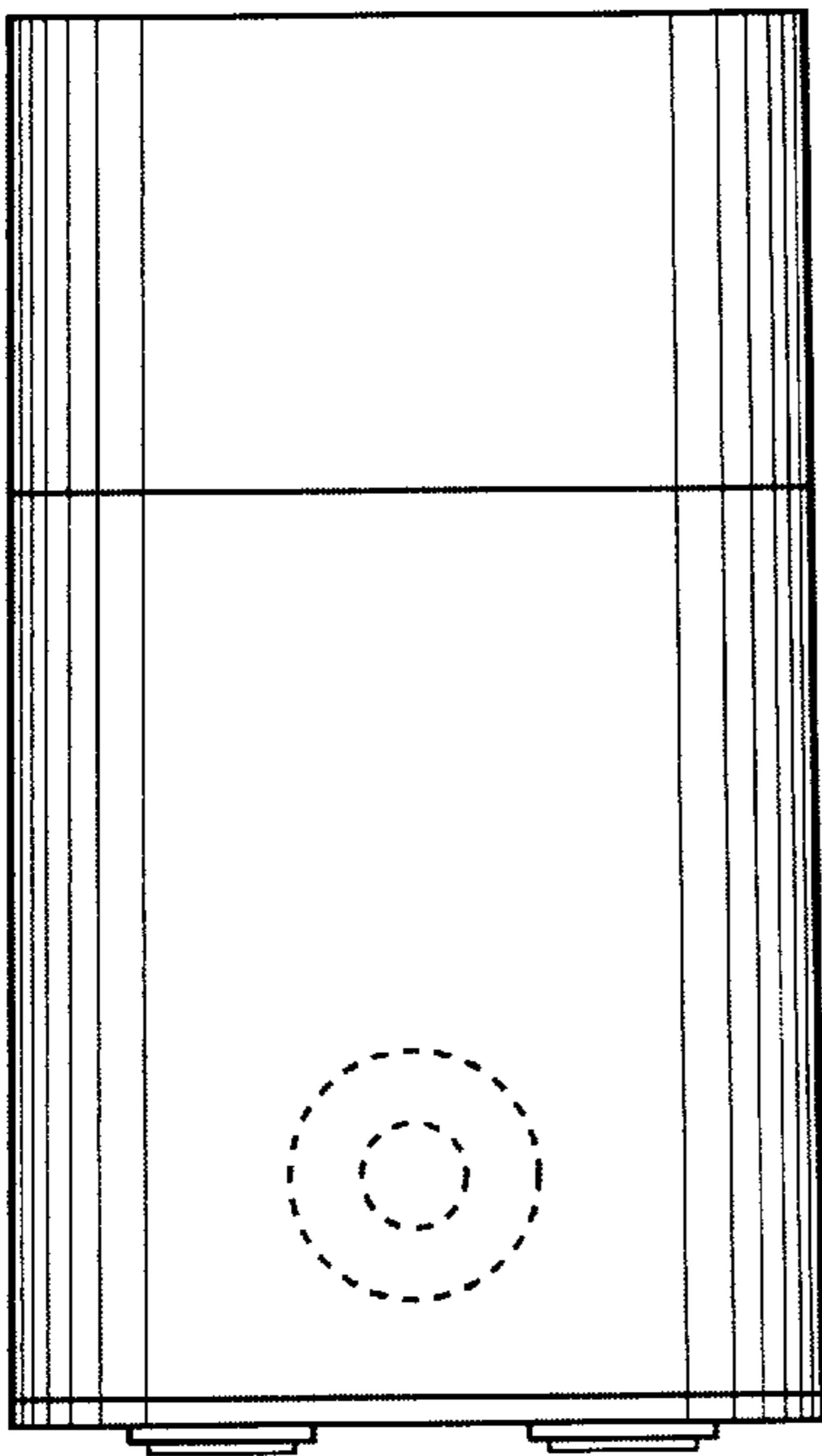

Figure 5

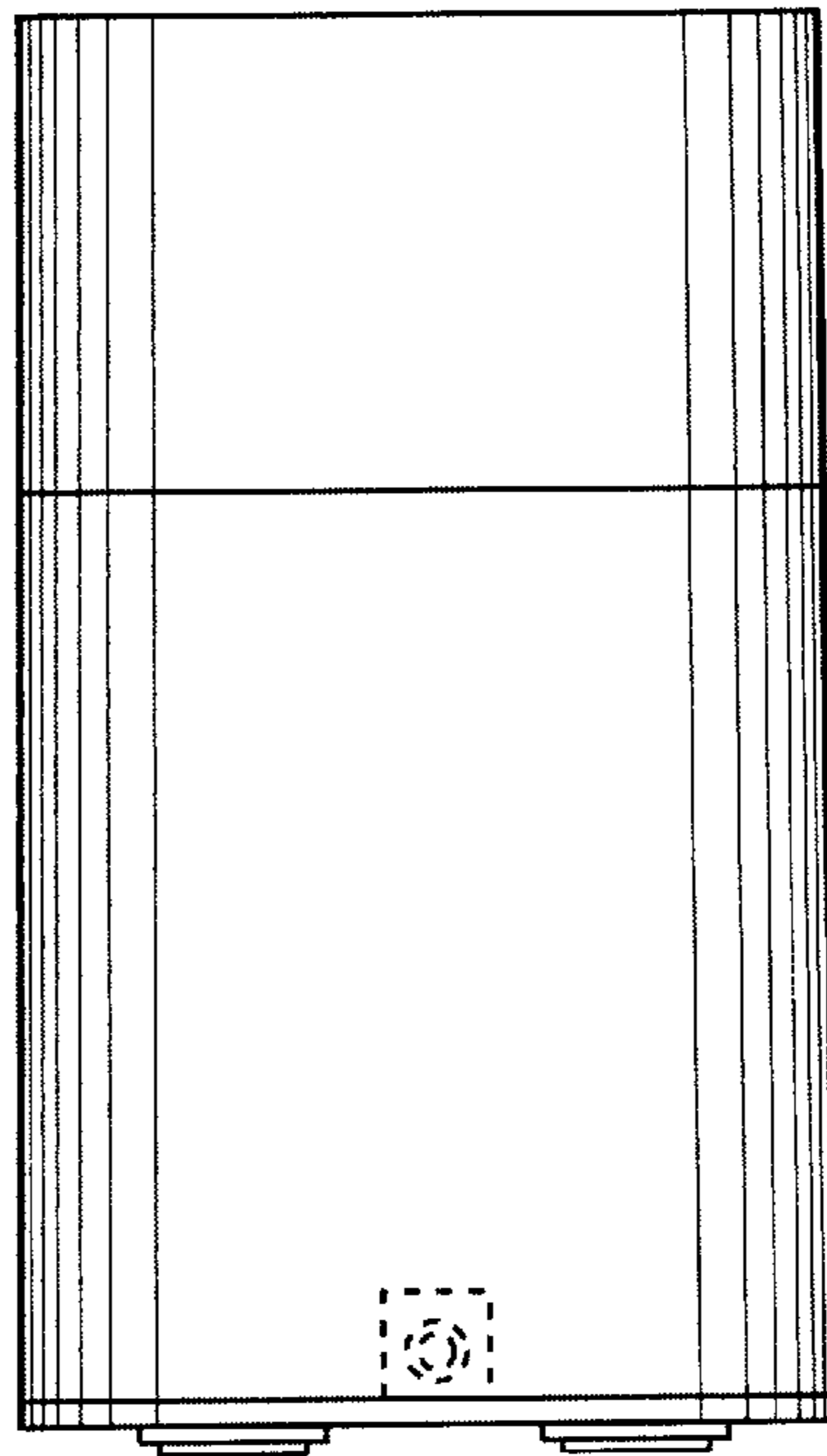

Figure 6

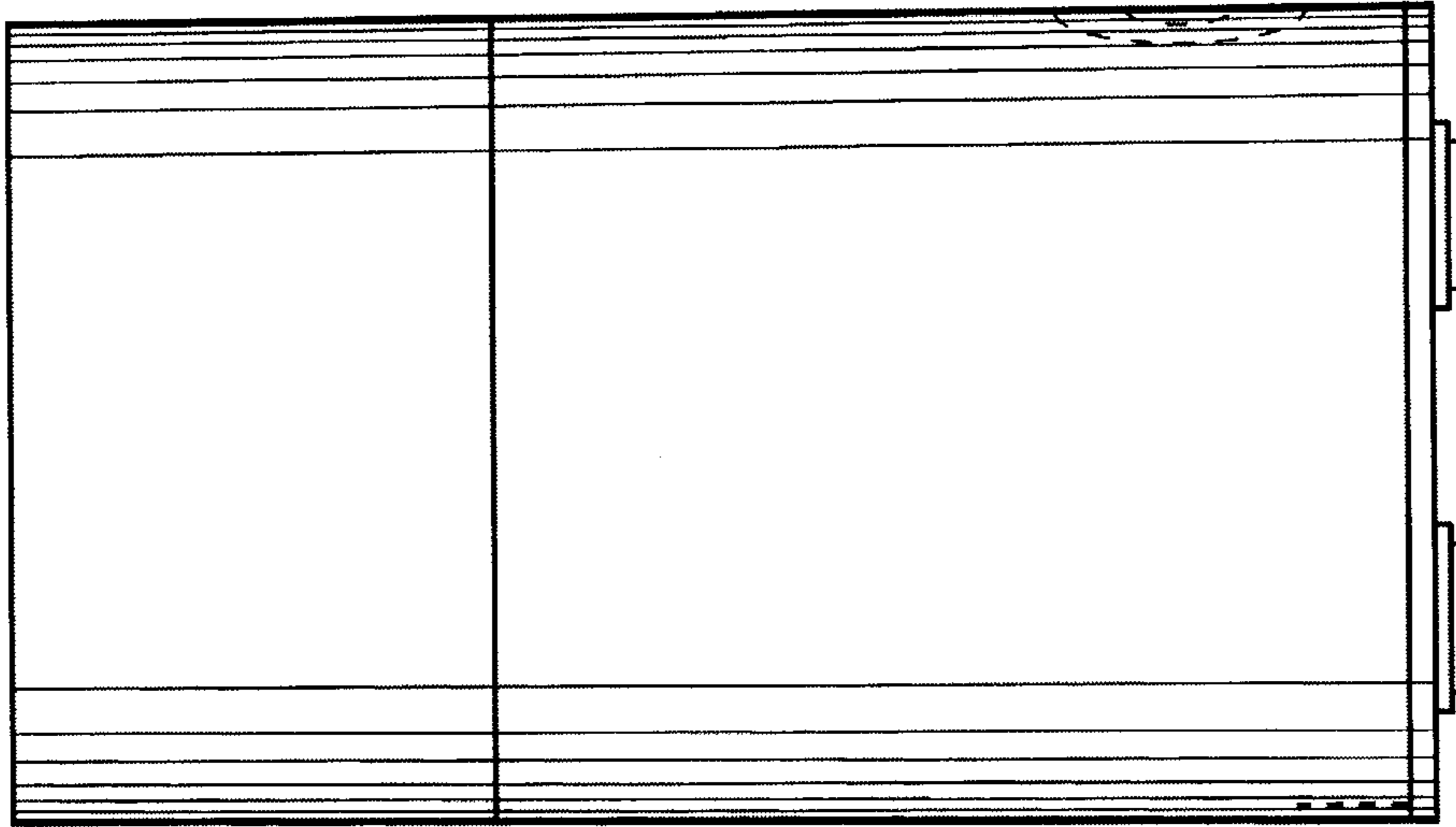

Figure 8

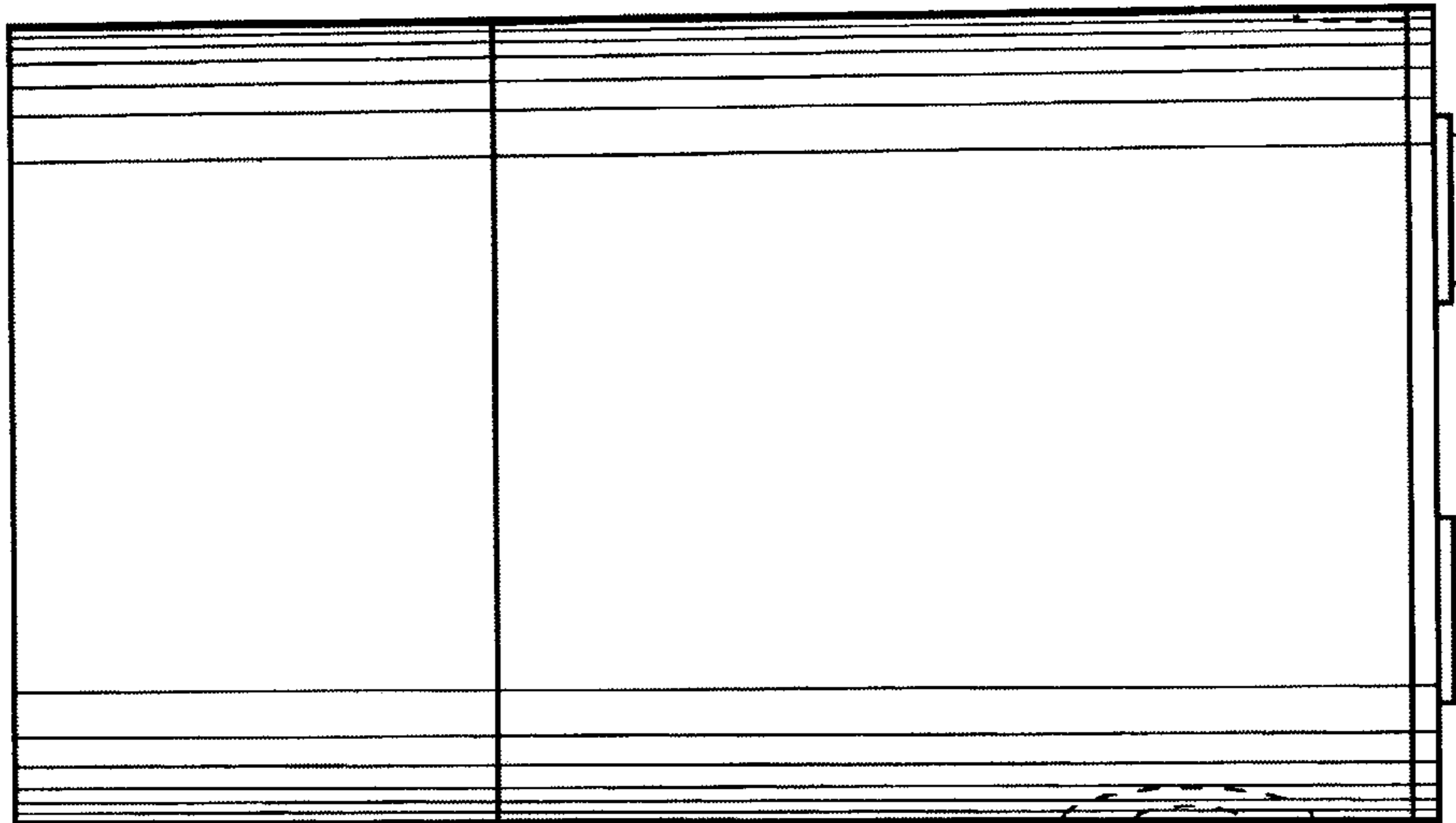

Figure 7

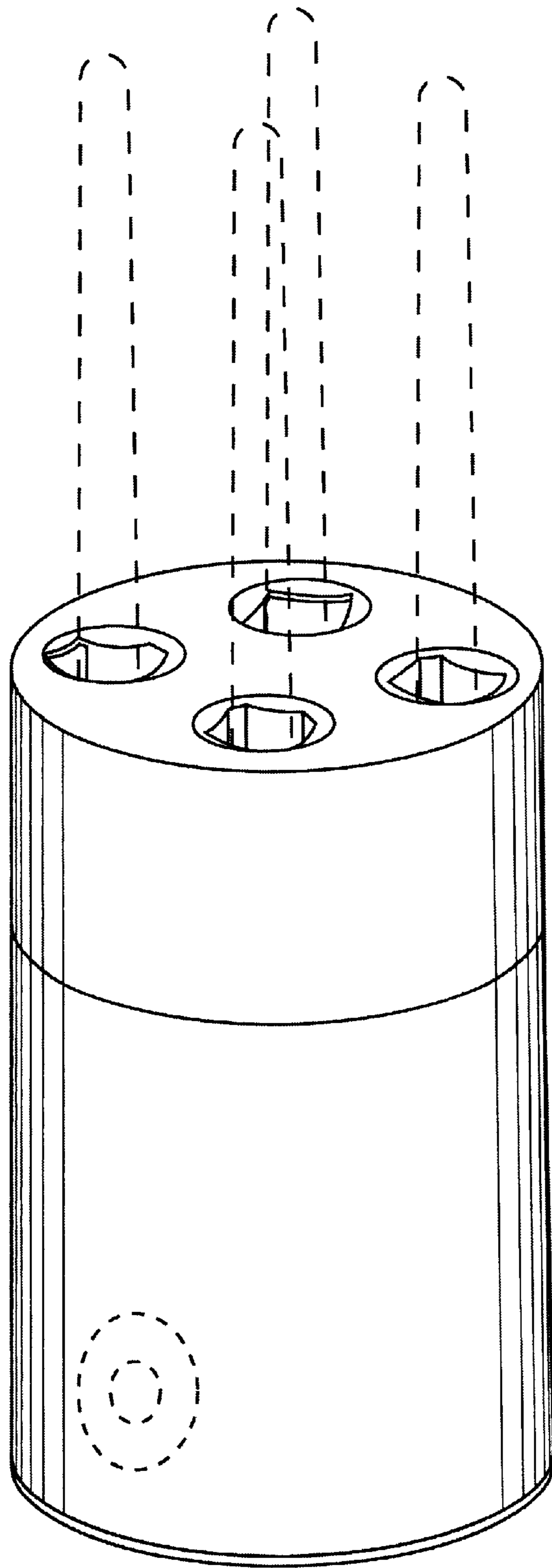

Figure 9