



US00D539566S

(12) **United States Design Patent** (10) **Patent No.:** **US D539,566 S**
Anderson (45) **Date of Patent:** **** Apr. 3, 2007**

(54) **DISPLAY STAND**

(75) Inventor: **Donald Lee Anderson**, Oak Park, IL (US)

(73) Assignee: **Peerless Industries, Inc.**, Melrose Park, IL (US)

(**) Term: **14 Years**

(21) Appl. No.: **29/264,328**

(22) Filed: **Aug. 8, 2006**

(51) **LOC (8) Cl.** **06-04**

(52) **U.S. Cl.** **D6/474; D6/477**

(58) **Field of Classification Search** D6/460, D6/461, 468, 474, 477-479; D14/129; 312/7.2, 312/9.1; 108/59, 91, 92, 96; 211/40, 41.12, 211/42, 49.1, 50, 85.2, 90.04, 187, 190, 119.003, 211/134.153, 87.01, 71.01
See application file for complete search history.

(56) **References Cited**

U.S. PATENT DOCUMENTS

D469,980 S	*	2/2003	Pressoir	D6/426
D495,163 S	*	8/2004	Weatherly	D6/479
D507,900 S	*	8/2005	Sexton	D6/474
D517,349 S	*	3/2006	Lara	D6/477

* cited by examiner

Primary Examiner—Cathron C. Brooks

(74) *Attorney, Agent, or Firm*—Foley & Lardner LLP

(57) **CLAIM**

I claim the ornamental design for a display stand, as shown and described.

DESCRIPTION

FIG. 1 is a perspective view of the display stand showing our new design;

FIG. 2 is a front view thereof;

FIG. 3 is a rear view thereof;

FIG. 4 is a left side view thereof;

FIG. 5 is a right side view thereof;

FIG. 6 is a top plan view thereof;

FIG. 7 is a bottom view thereof;

FIG. 8 is a perspective view of another embodiment of the display stand showing our new design;

FIG. 9 is a front view of the display stand in FIG. 8;

FIG. 10 is a rear view of the display stand in FIG. 8;

FIG. 11 is a left side view of the display stand in FIG. 8;

FIG. 12 is right side view of the display stand in FIG. 8;

FIG. 13 is a top plan view of the display stand in FIG. 8; and,

FIG. 14 is a bottom view of the display stand in FIG. 8.

The broken lines in the drawings are for illustrative purposes only and form no part of the claimed design.

1 Claim, 12 Drawing Sheets

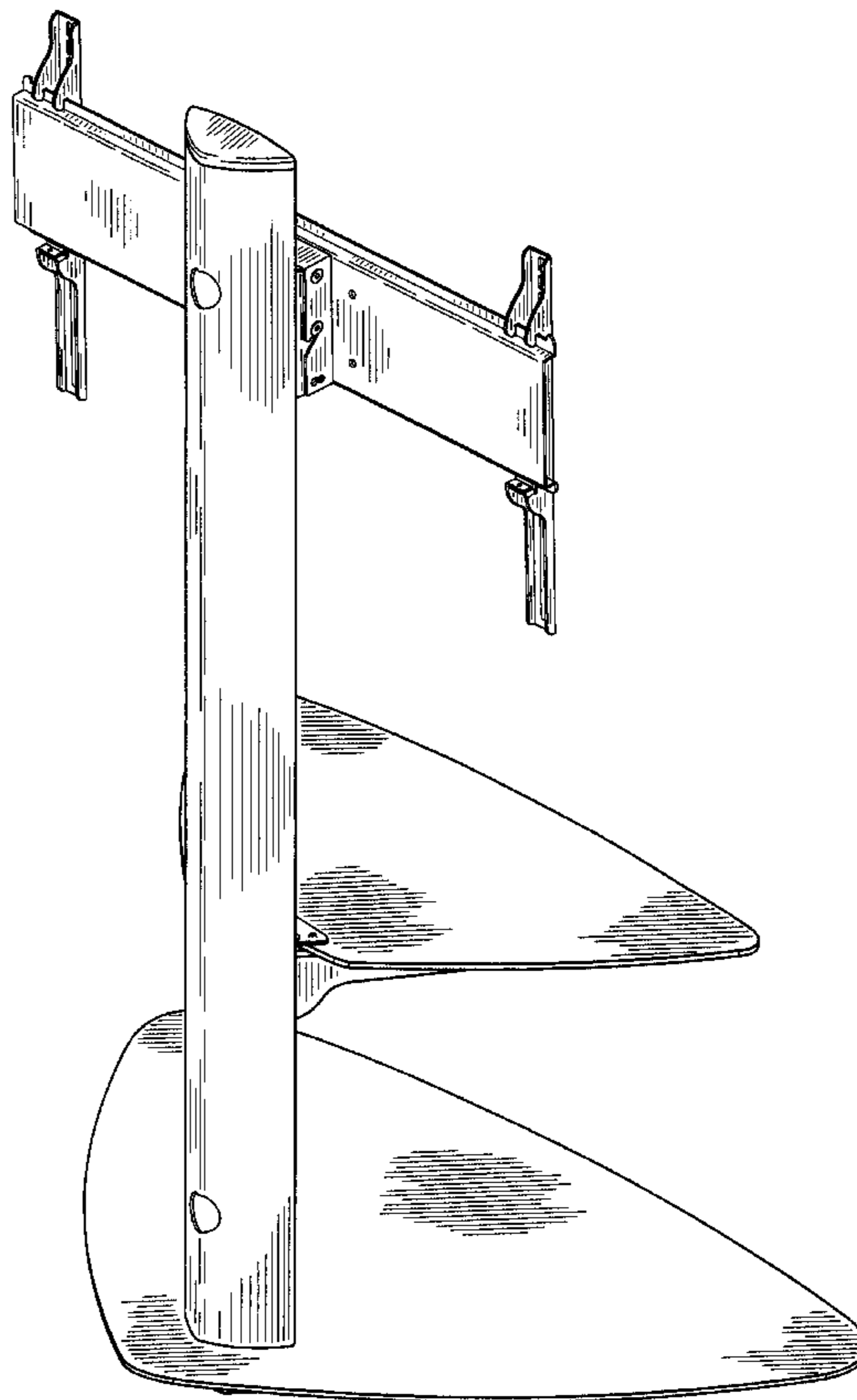

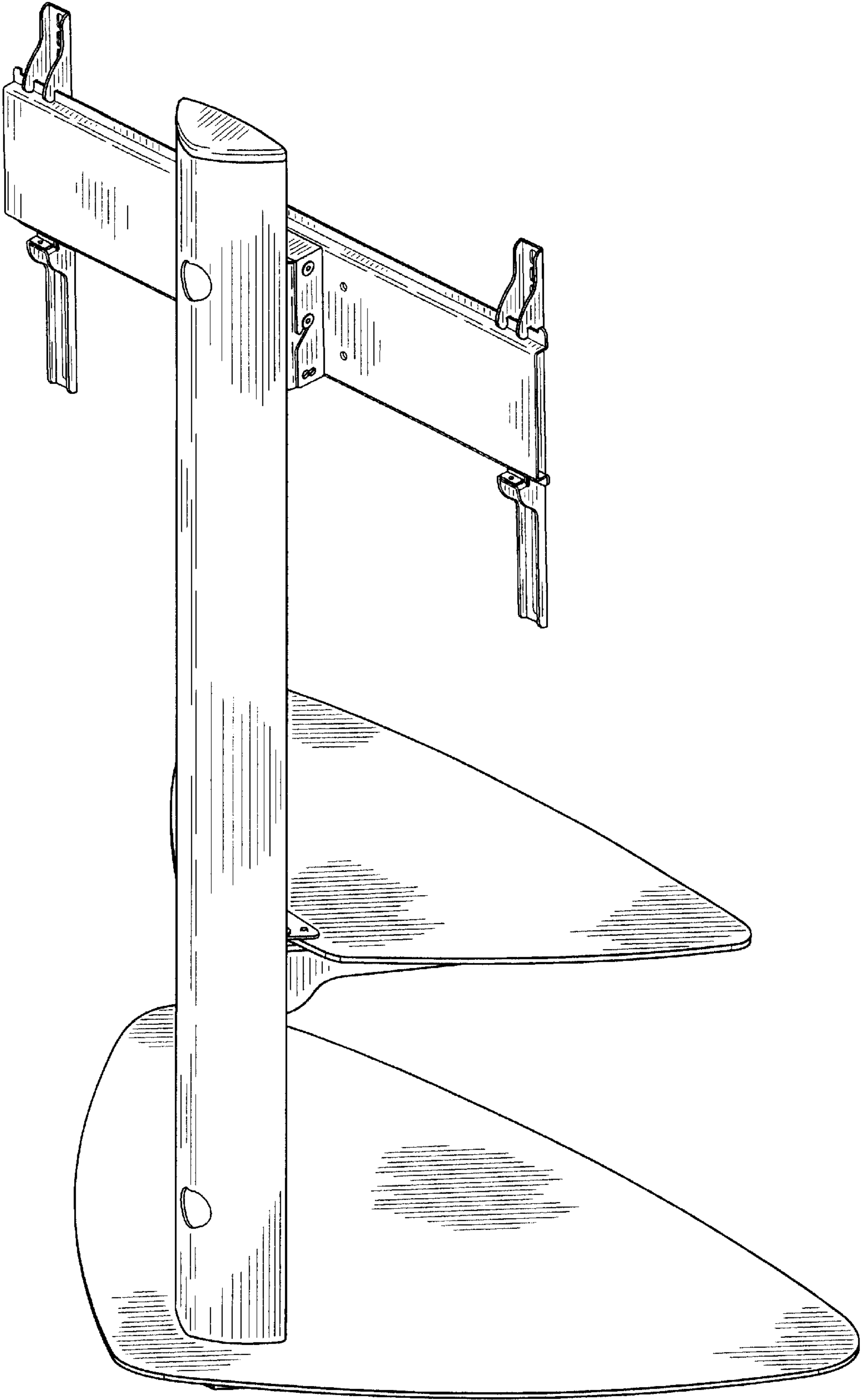

FIG. 1

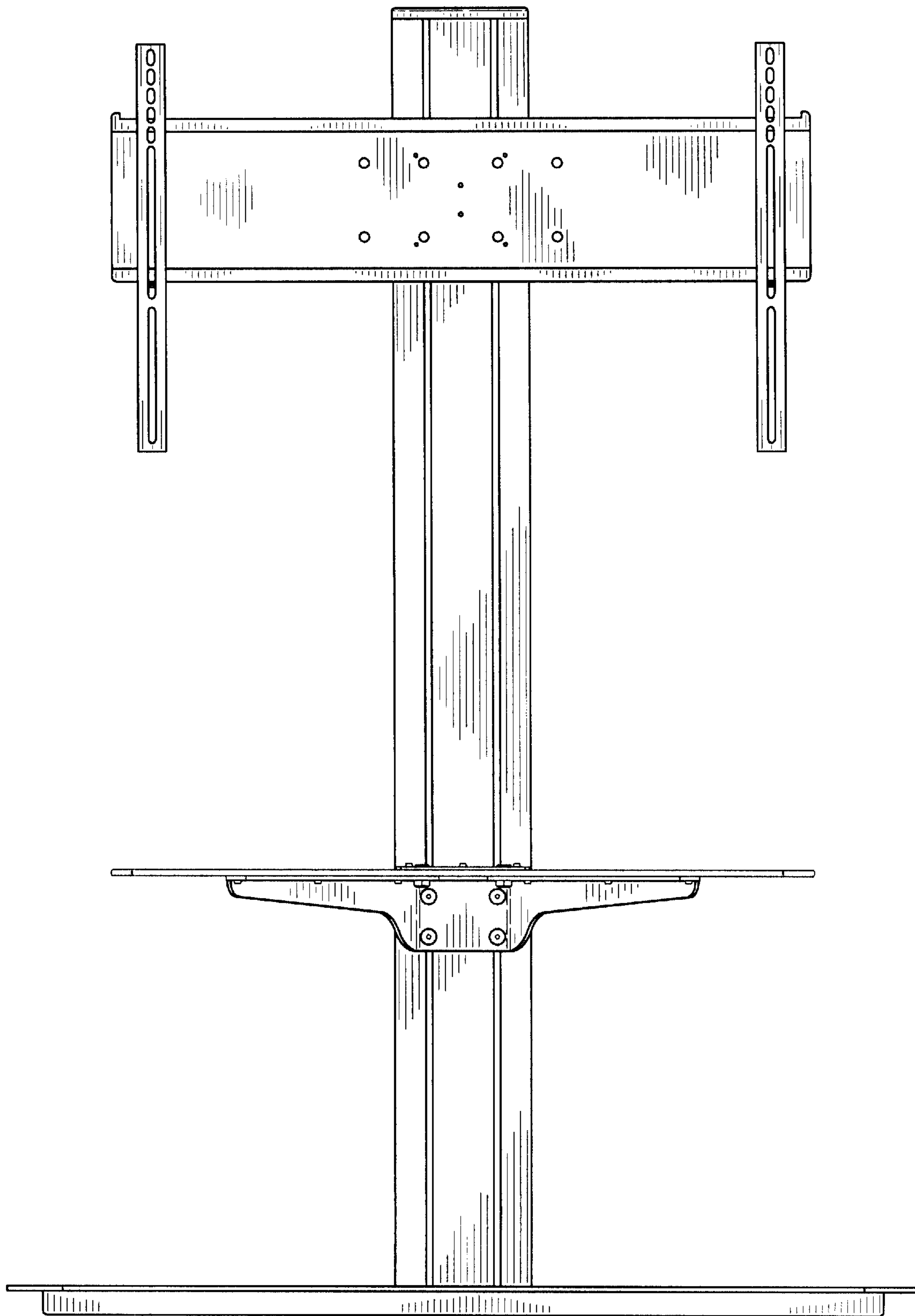

FIG. 2

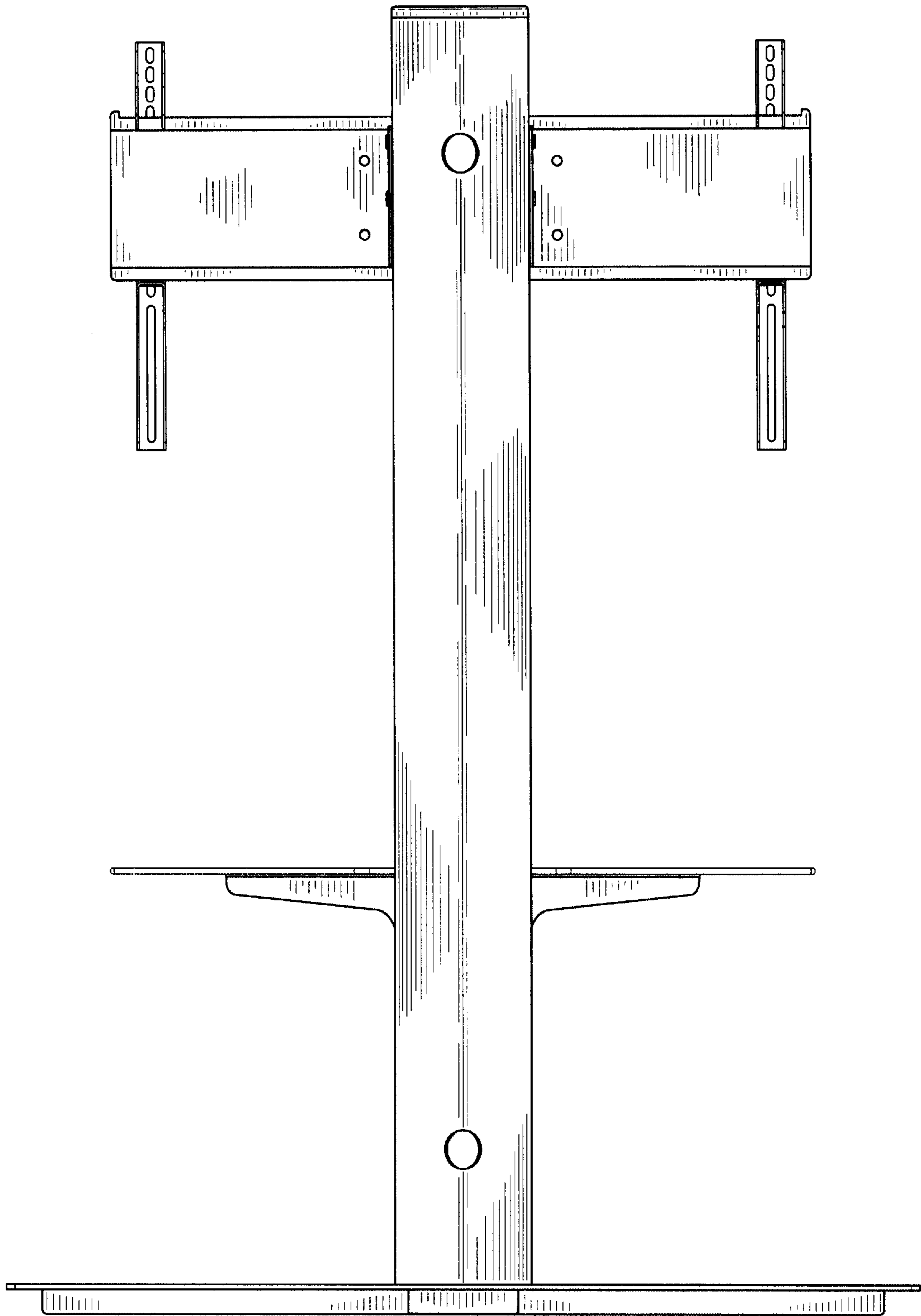

FIG. 3

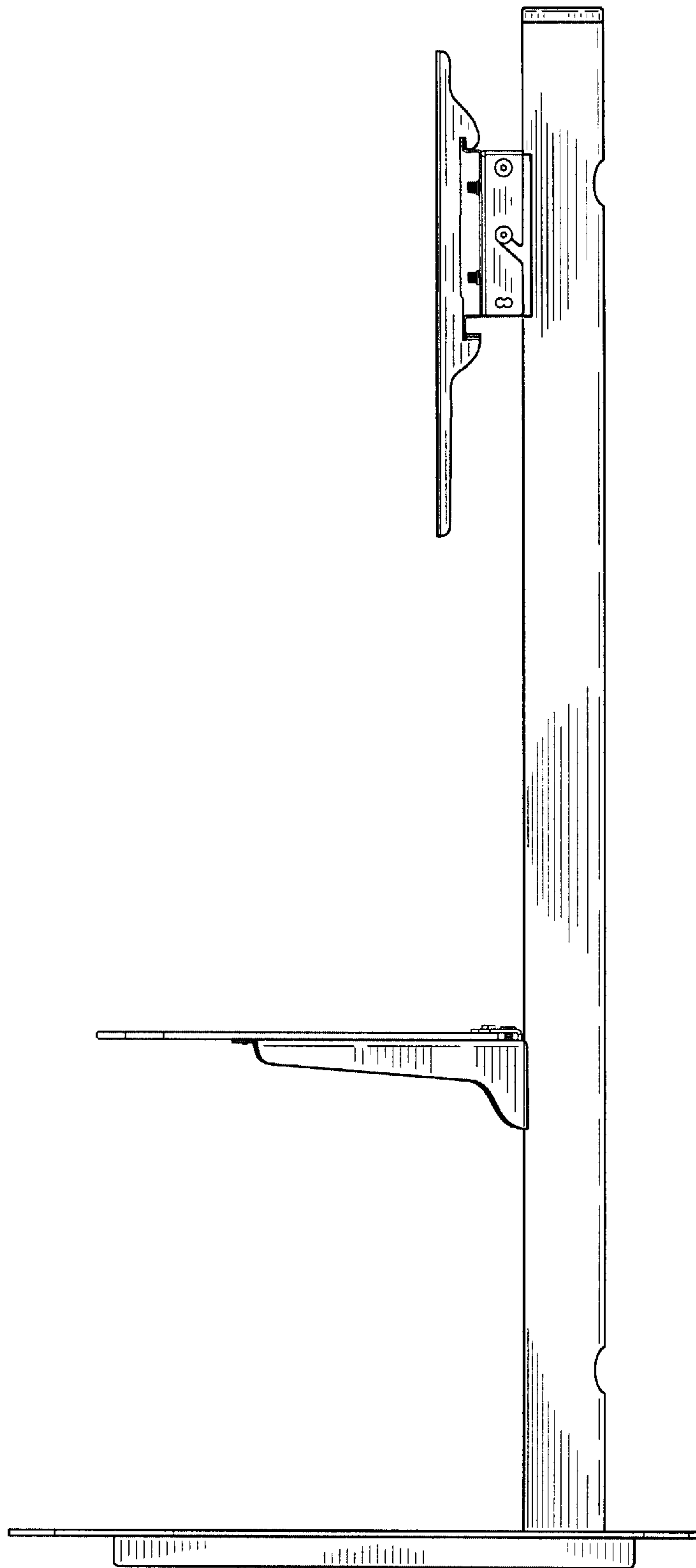

FIG. 4

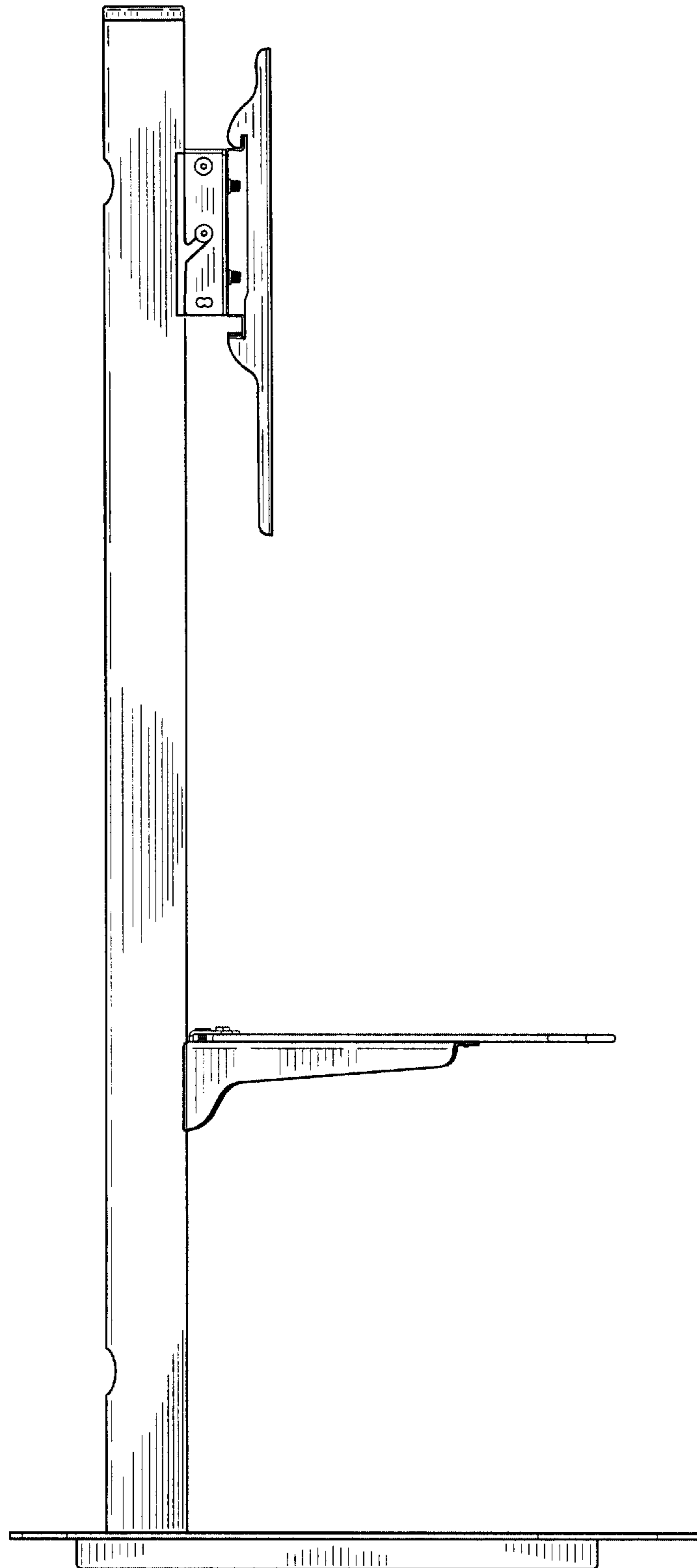

FIG. 5

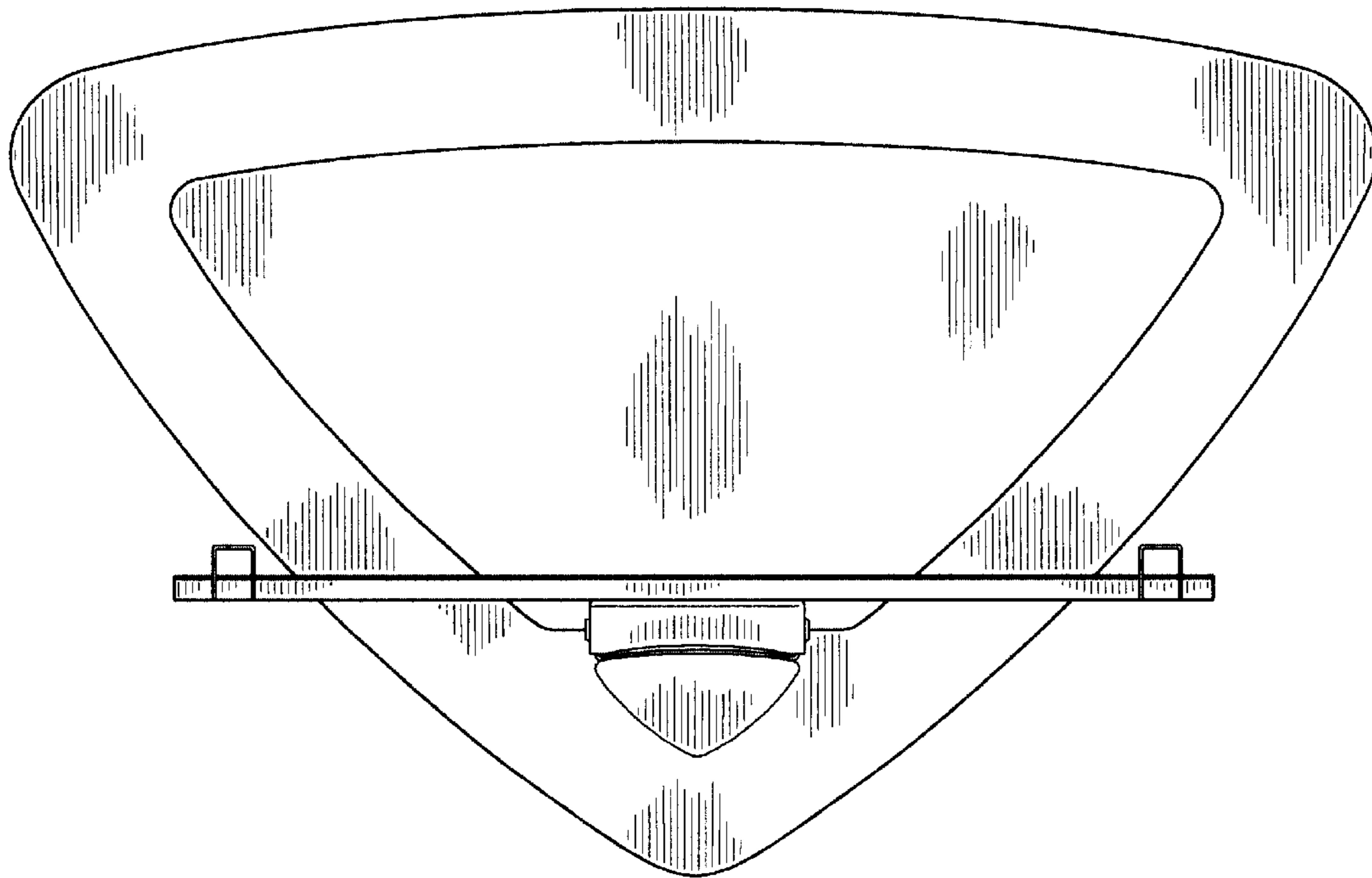

FIG. 6

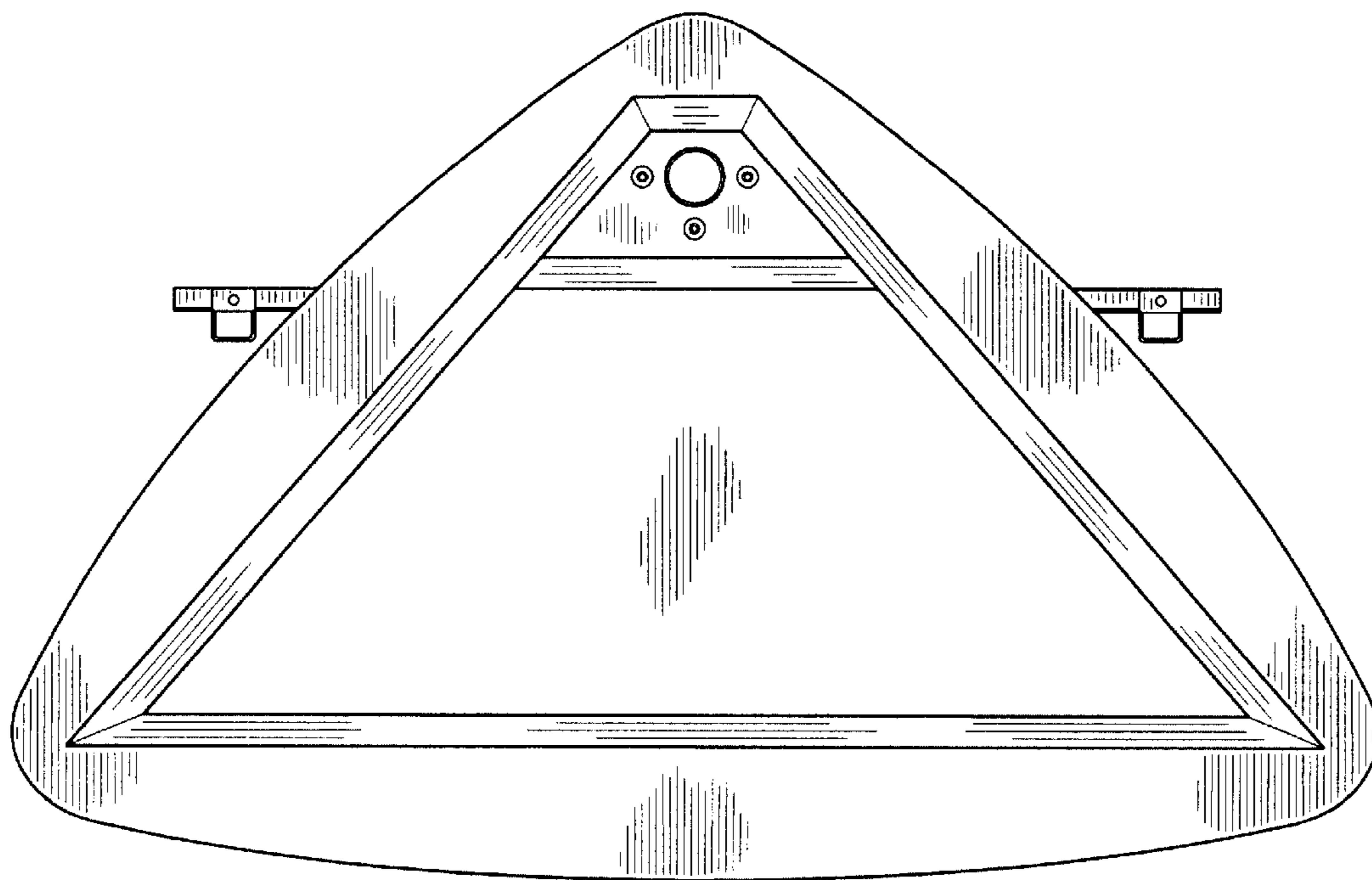

FIG. 7

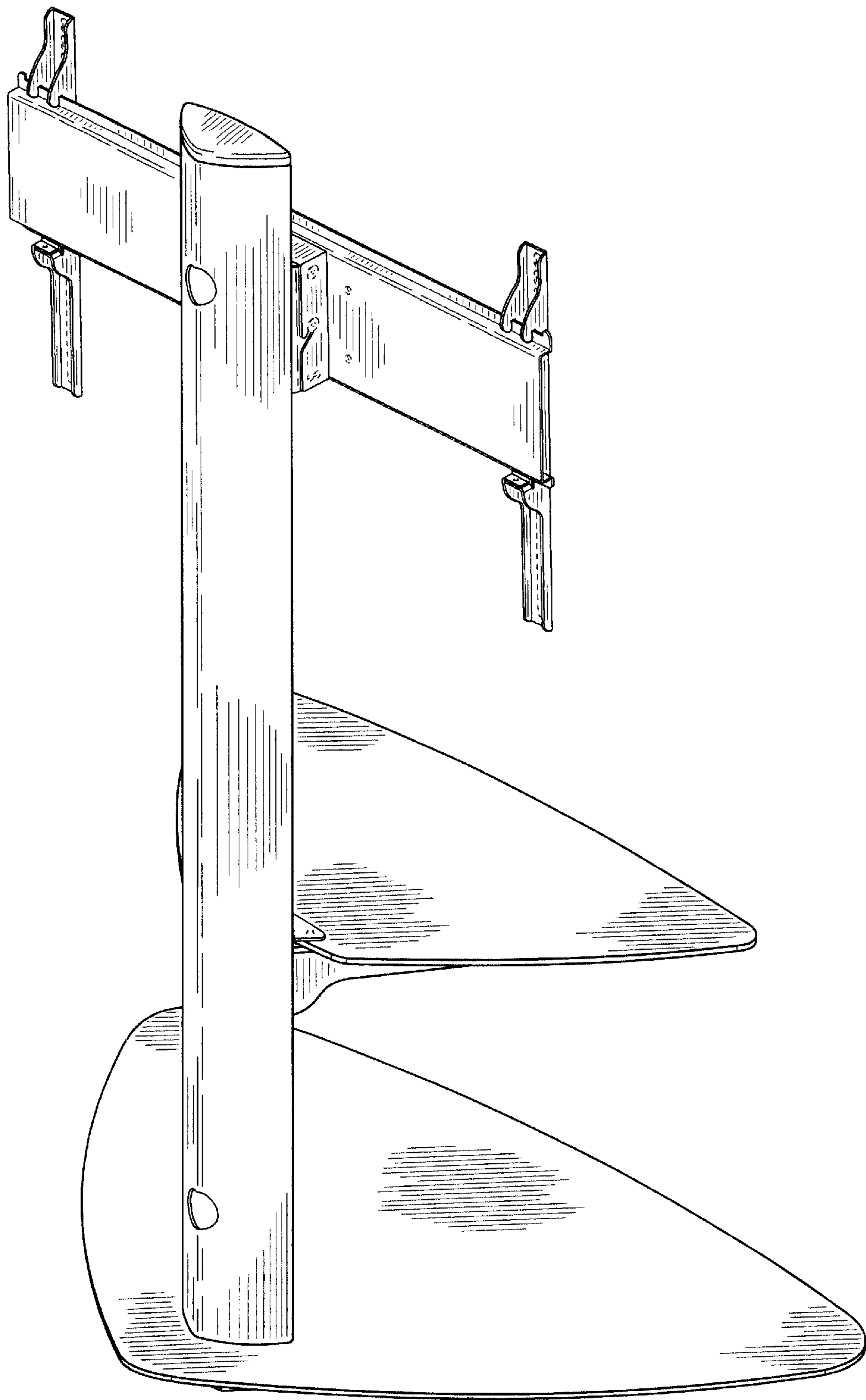

FIG. 8

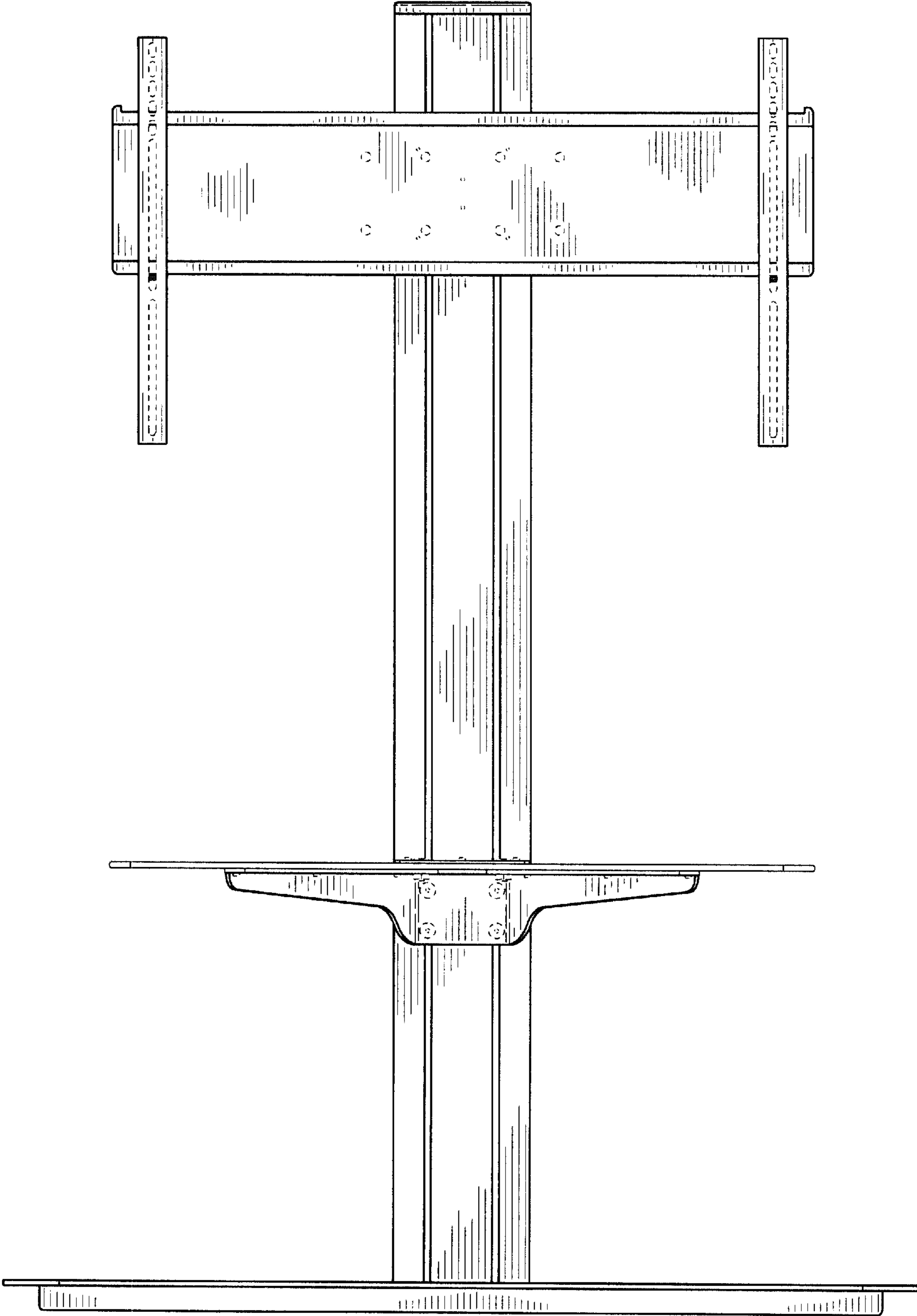

FIG. 9

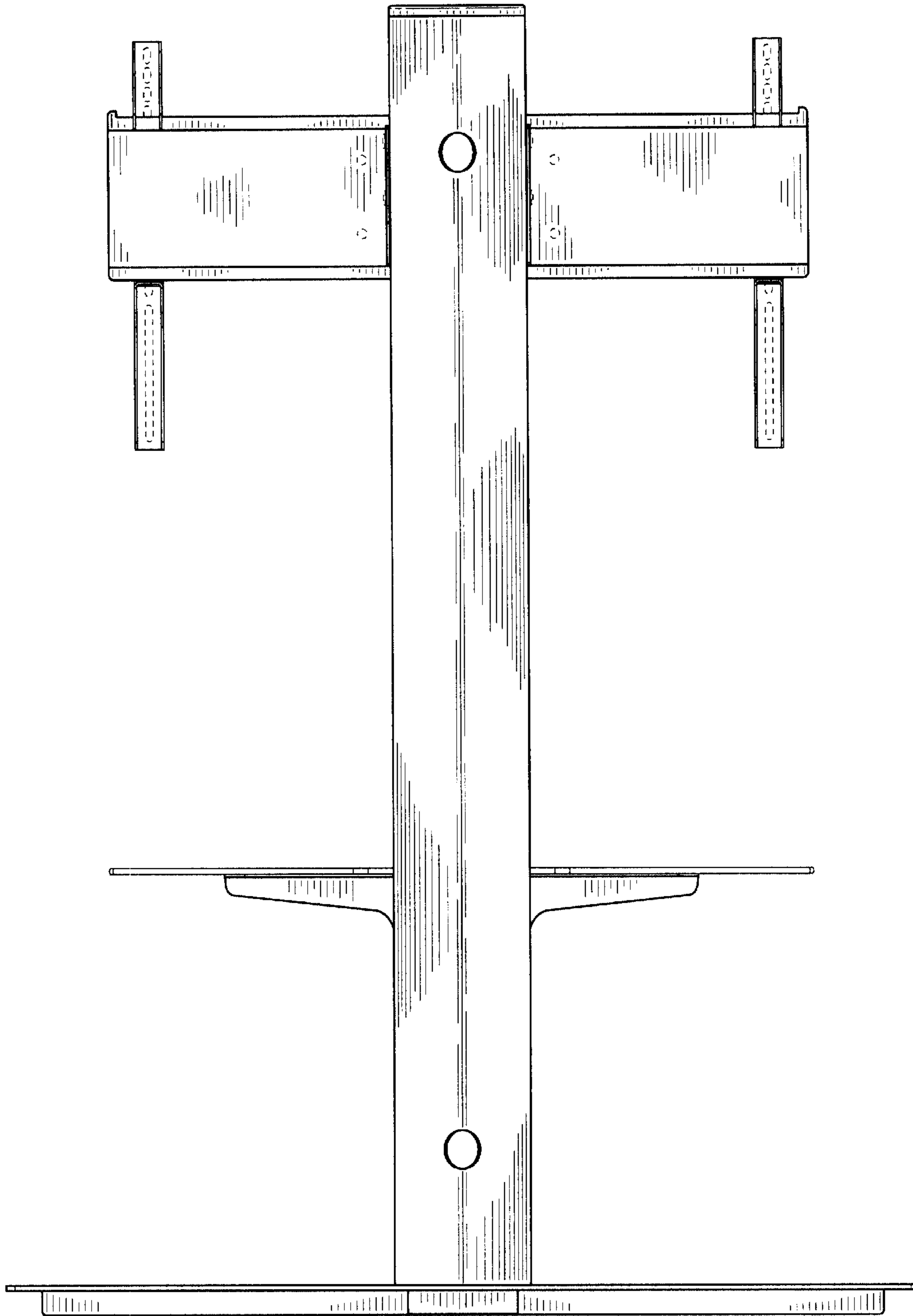

FIG. 10

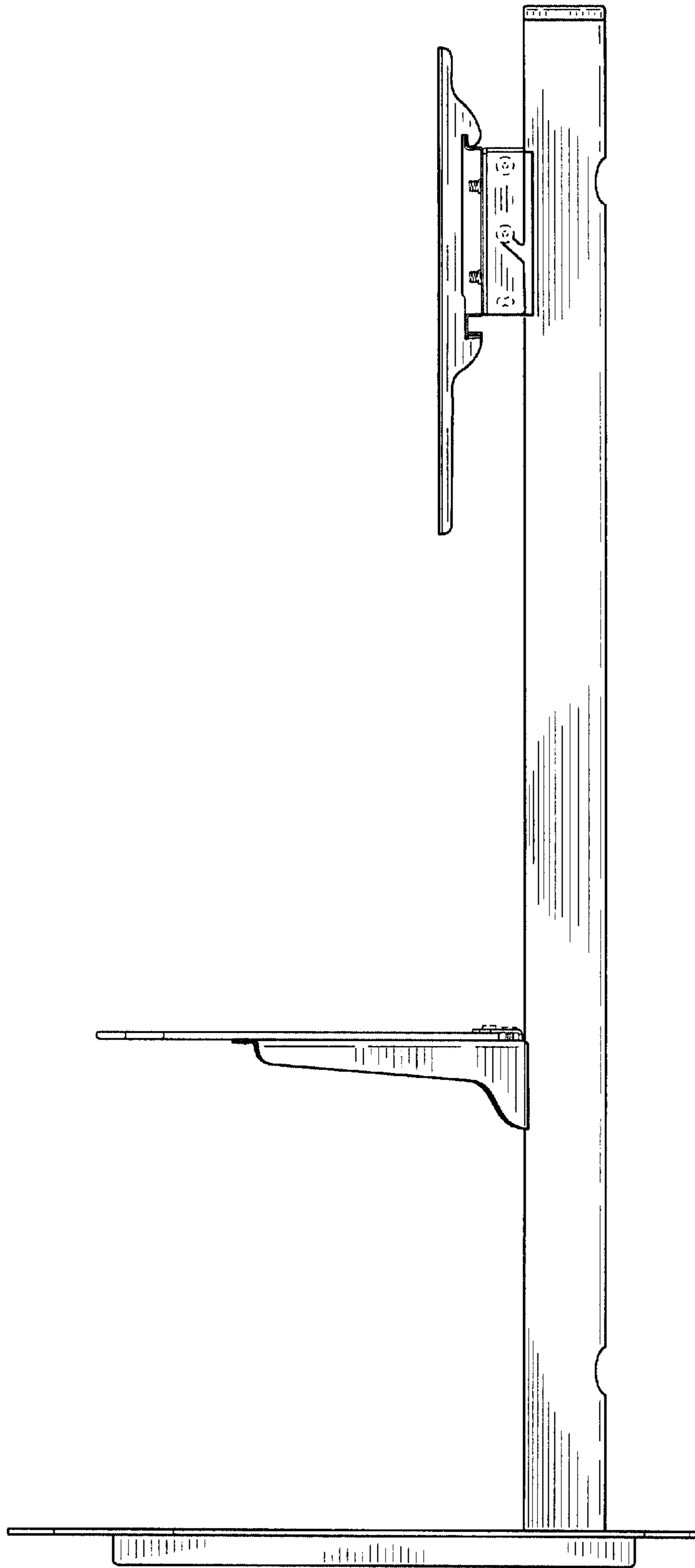

FIG. 11

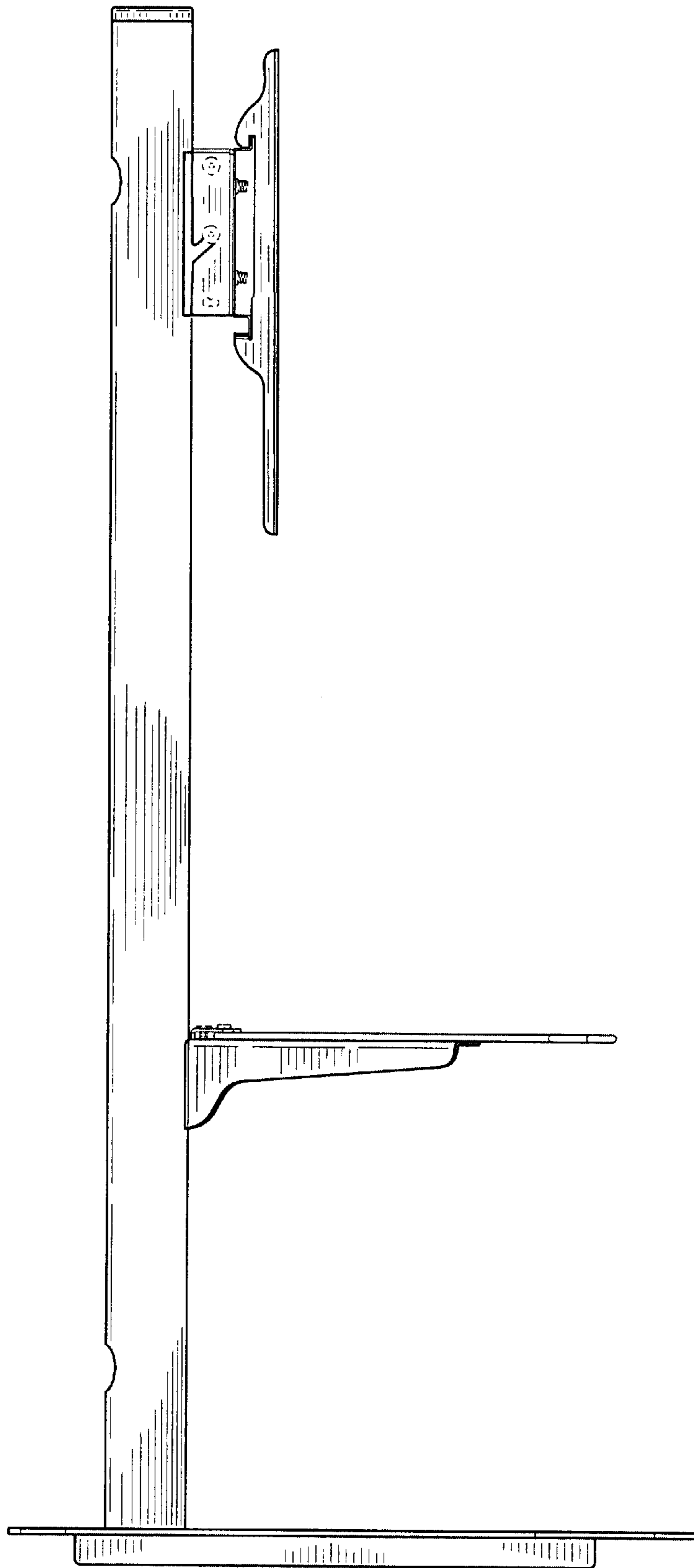

FIG. 12

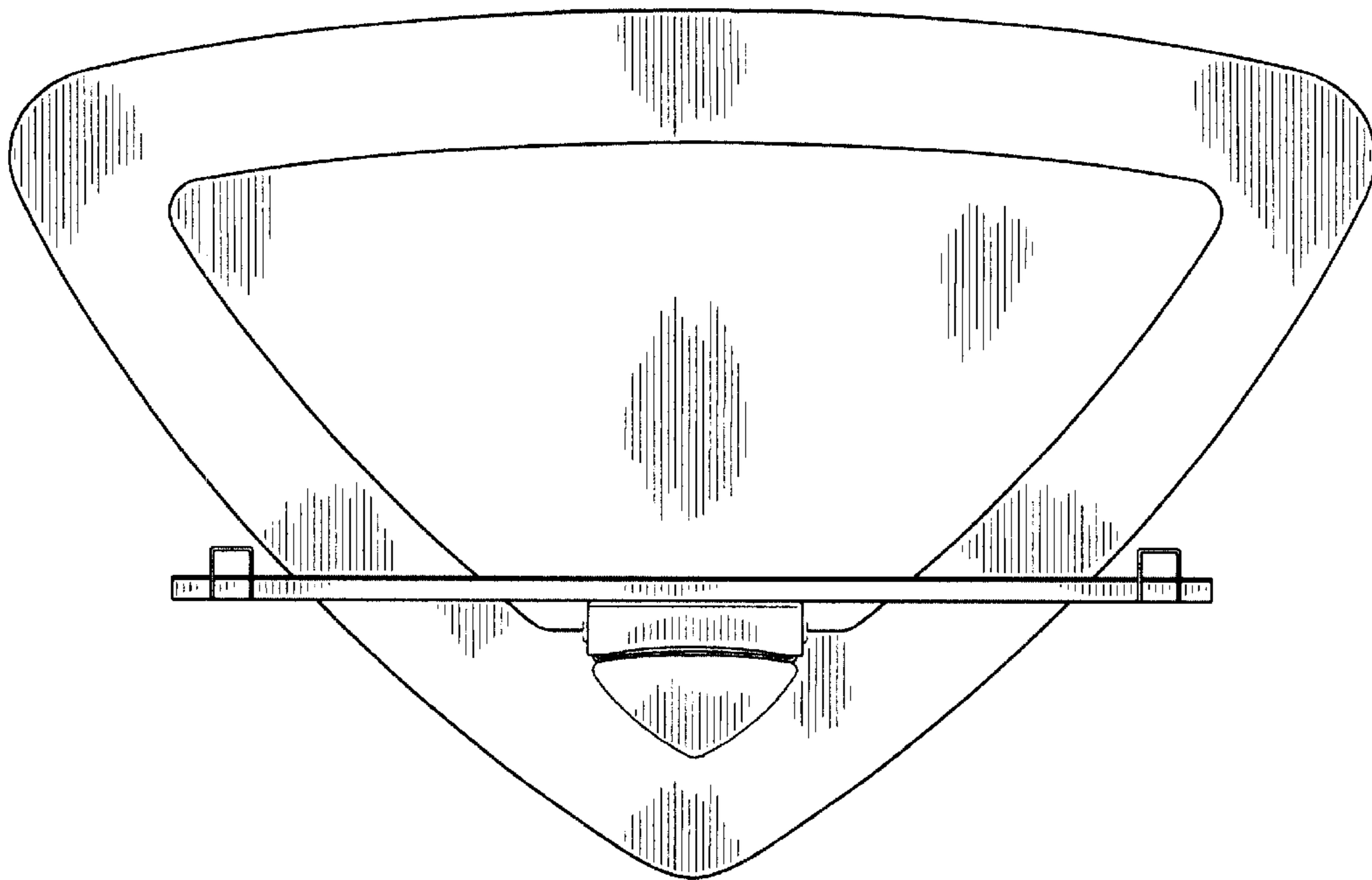

FIG. 13

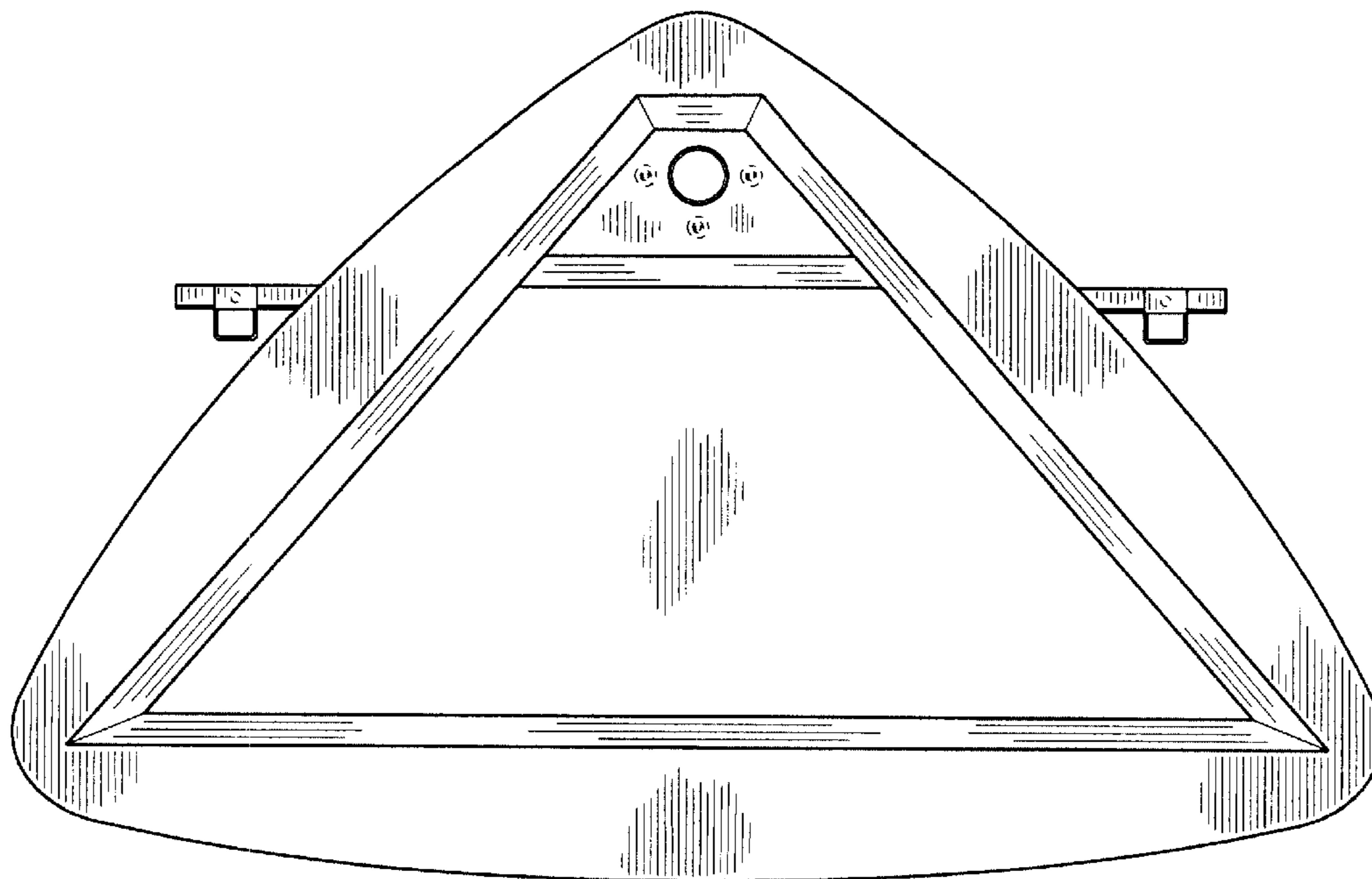

FIG. 14