



US00D539562S

(12) **United States Design Patent**  
**Lown et al.**

(10) **Patent No.:** **US D539,562 S**  
(45) **Date of Patent:** **\*\* Apr. 3, 2007**

(54) **GIFT WRAPPING TABLE**

(75) Inventors: **John M. Lown**, Huntington Beach, CA (US); **Ali Nikkhah**, Mission Viejo, CA (US)

(73) Assignee: **Snapware Corporation**

(\*\*) Term: **14 Years**

(21) Appl. No.: **29/226,751**

(22) Filed: **Mar. 31, 2005**

(51) **LOC (8) Cl.** ..... **06-03**

(52) **U.S. Cl.** ..... **D6/426; D6/487**

(58) **Field of Classification Search** ..... D6/480-489, D6/495, 511, 429-431, 499; 108/150, 153.1, 108/155, 156, 161, 36, 127, 115, 123, 34, 108/35; 248/188, 188.1, 188.8; 190/11; D3/274  
See application file for complete search history.

(56) **References Cited**

**U.S. PATENT DOCUMENTS**

873,855	A	*	12/1907	Golden	.....	190/11
1,211,829	A	*	1/1917	Eades	.....	190/11
4,186,833	A		2/1980	Homan		
D273,149	S	*	3/1984	Fifield	.....	D3/290
5,509,361	A	*	4/1996	Chen	.....	108/131
6,006,502	A		12/1999	Smith		
6,036,011	A	*	3/2000	DeCurtis et al.	.....	206/320

6,123,197	A		9/2000	Marquez et al.		
6,266,942	B1		7/2001	McClore		
6,311,627	B1		11/2001	Draper et al.		
6,431,086	B1	*	8/2002	Lloyd	.....	108/36
D469,623	S	*	2/2003	Norbut, Jr.	.....	D6/429
6,612,436	B1		9/2003	Zullo		
6,698,589	B1		3/2004	Johnson		
6,725,753	B2		4/2004	Bell		
2004/0129123	A1		7/2004	Miller		

\* cited by examiner

*Primary Examiner*—Janice E. Seeger

(74) *Attorney, Agent, or Firm*—Harold L. Jackson

(57) **CLAIM**

The ornamental design for a gift wrapping table, as shown and described.

**DESCRIPTION**

FIG. 1 is a front perspective view of the table with the legs retracted and the table top in open condition; FIG. 2 is a top plan view of the table; FIG. 3 is a rear elevational view of the table with the legs retracted; FIG. 4 is a front perspective view of the table with the center portion of the table top in open condition; FIG. 5 is a bottom plan view of the table; and, FIG. 6 is a side elevational view of the table.

**1 Claim, 6 Drawing Sheets**

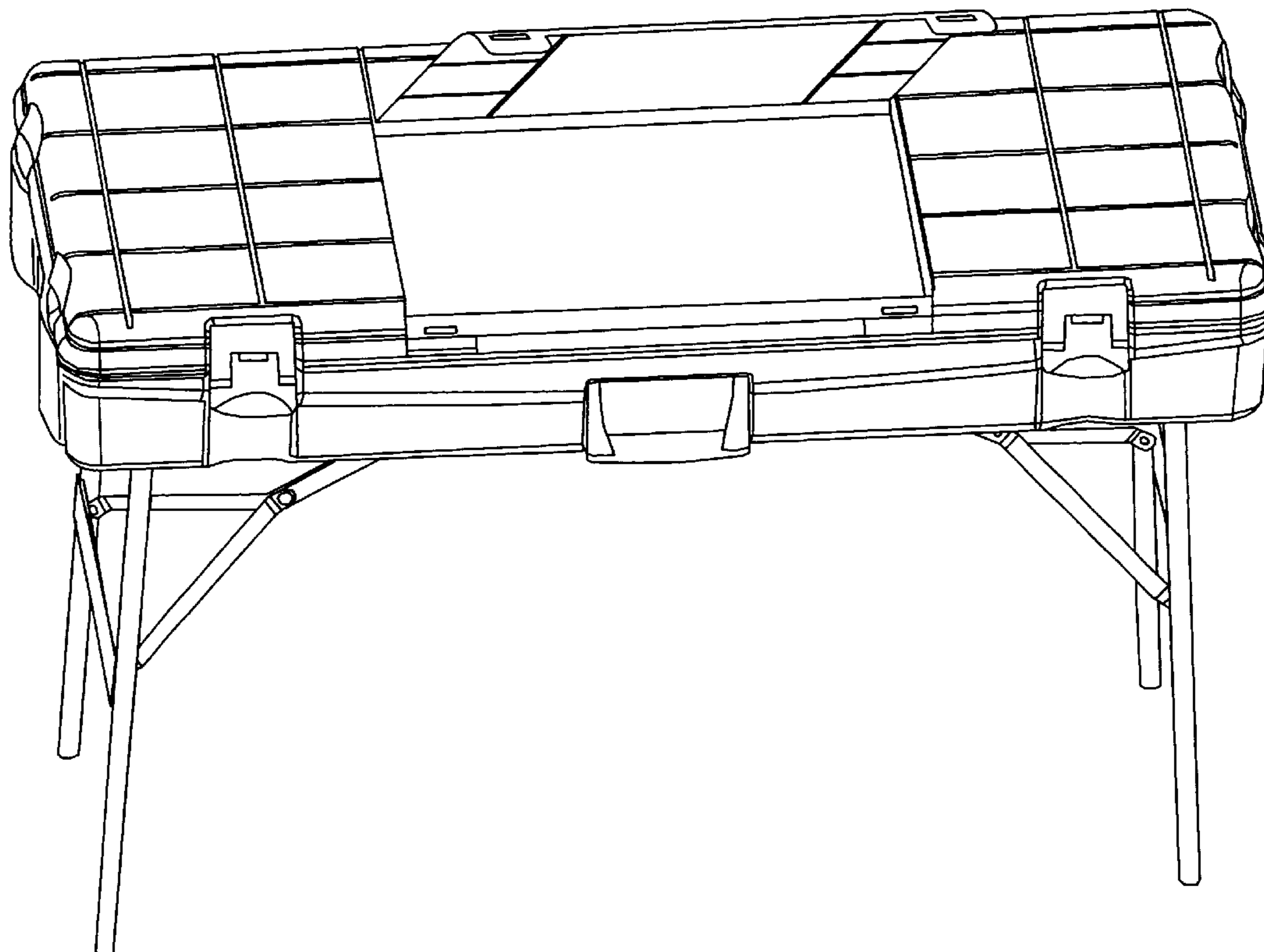

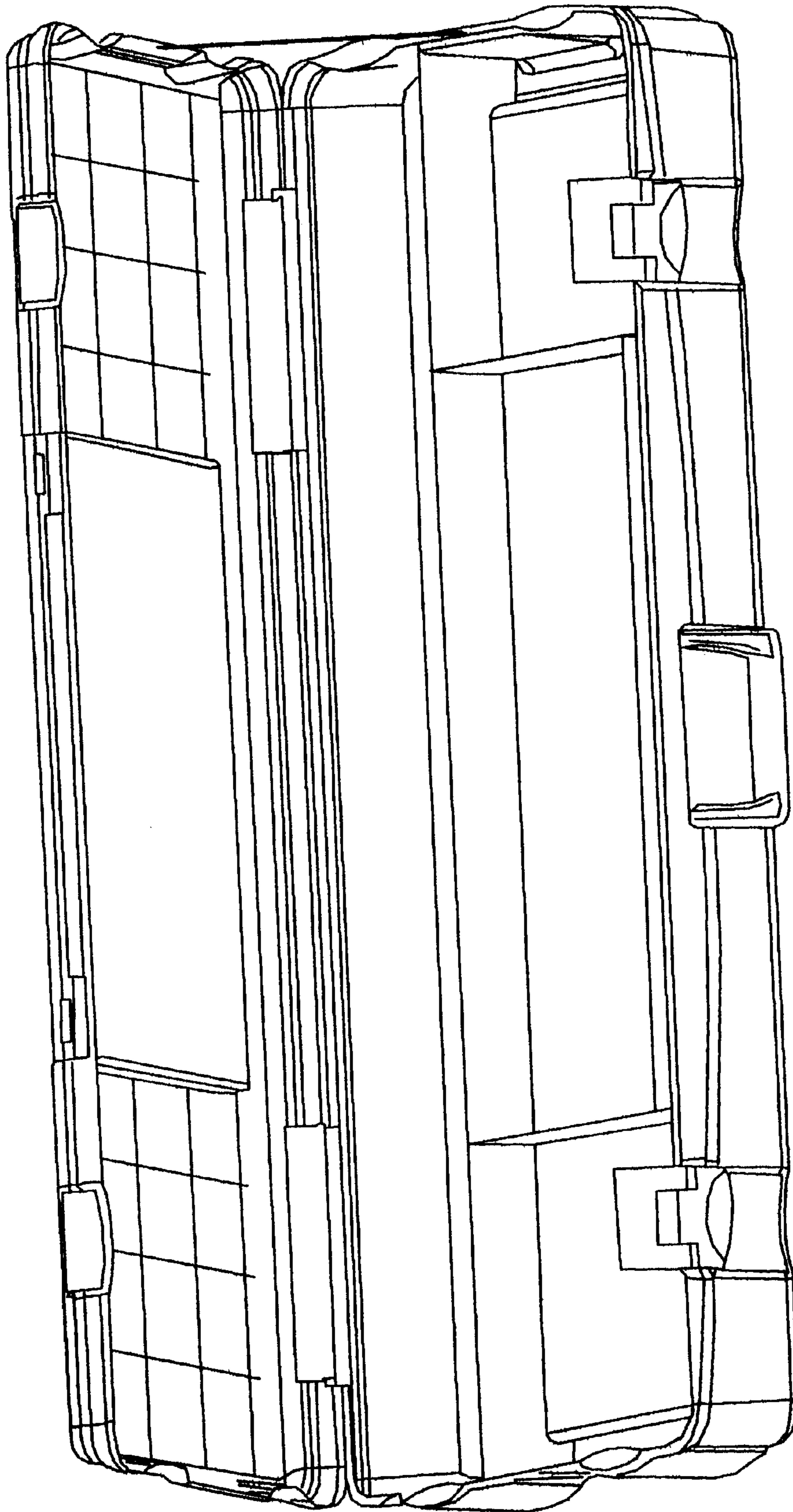

Figure 1

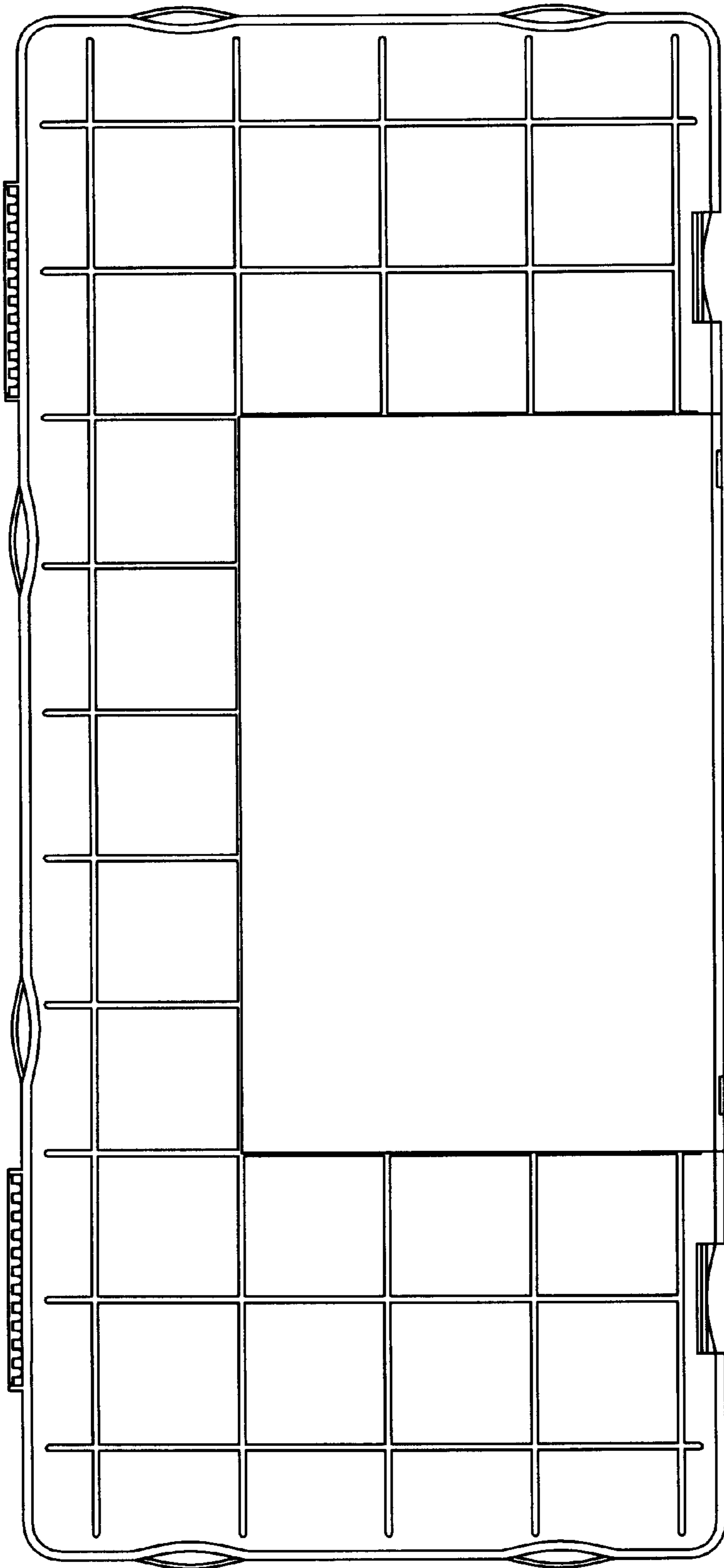

Figure 2

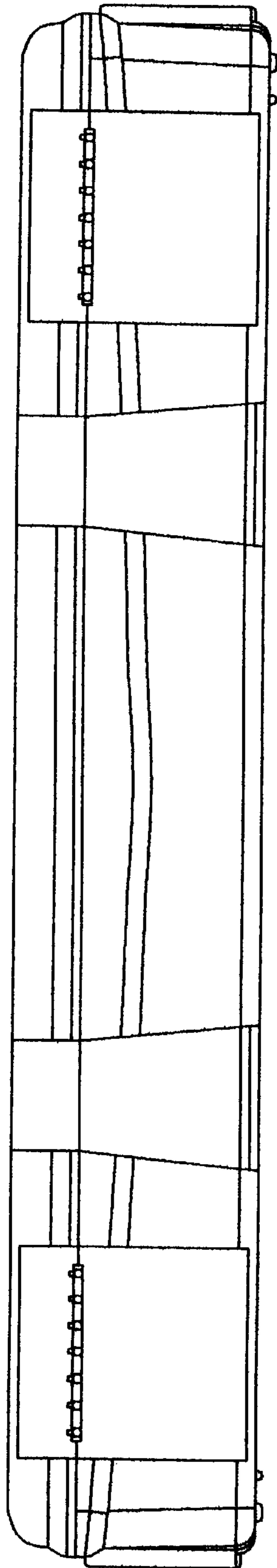

Figure 3

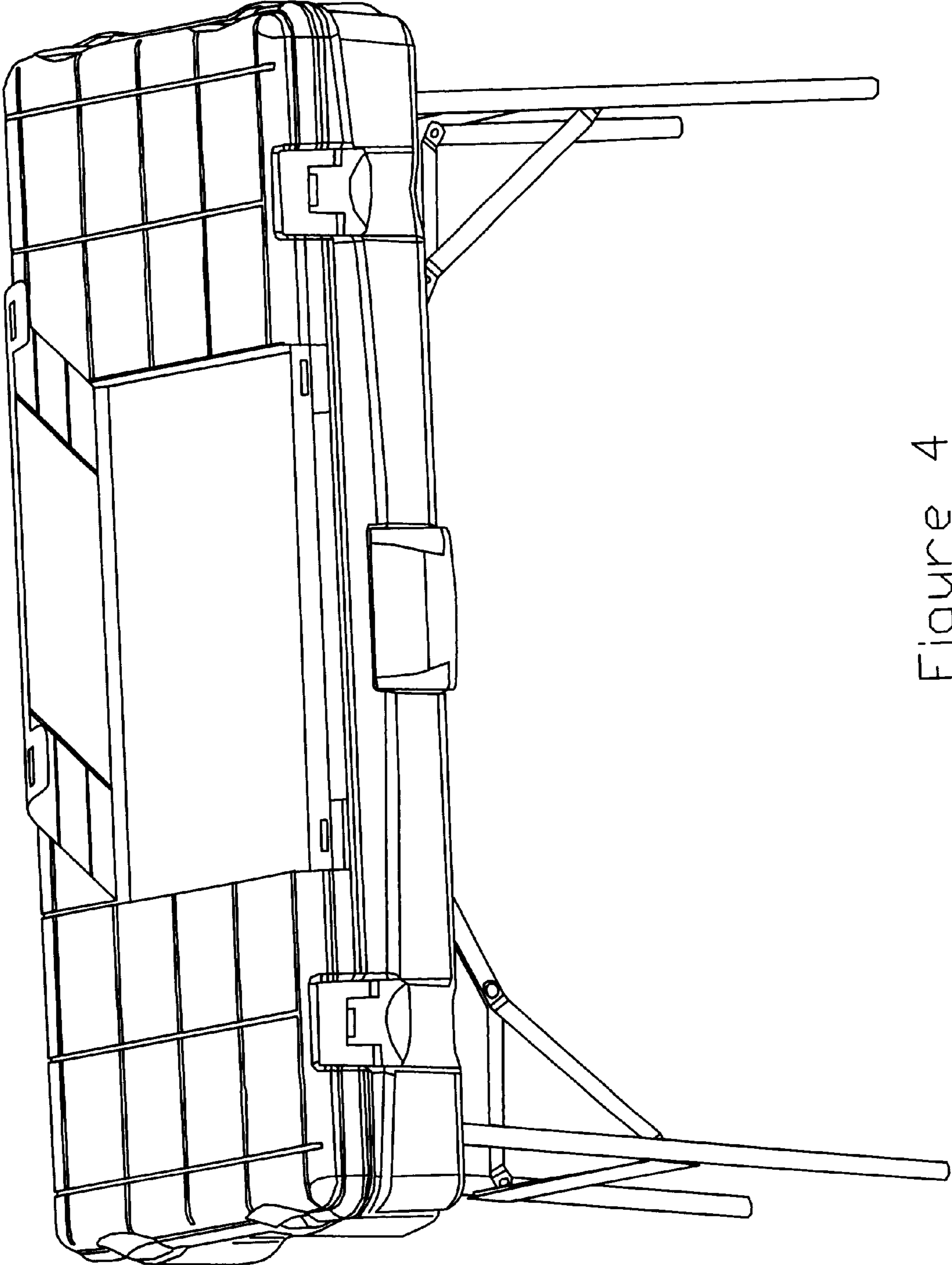

Figure 4

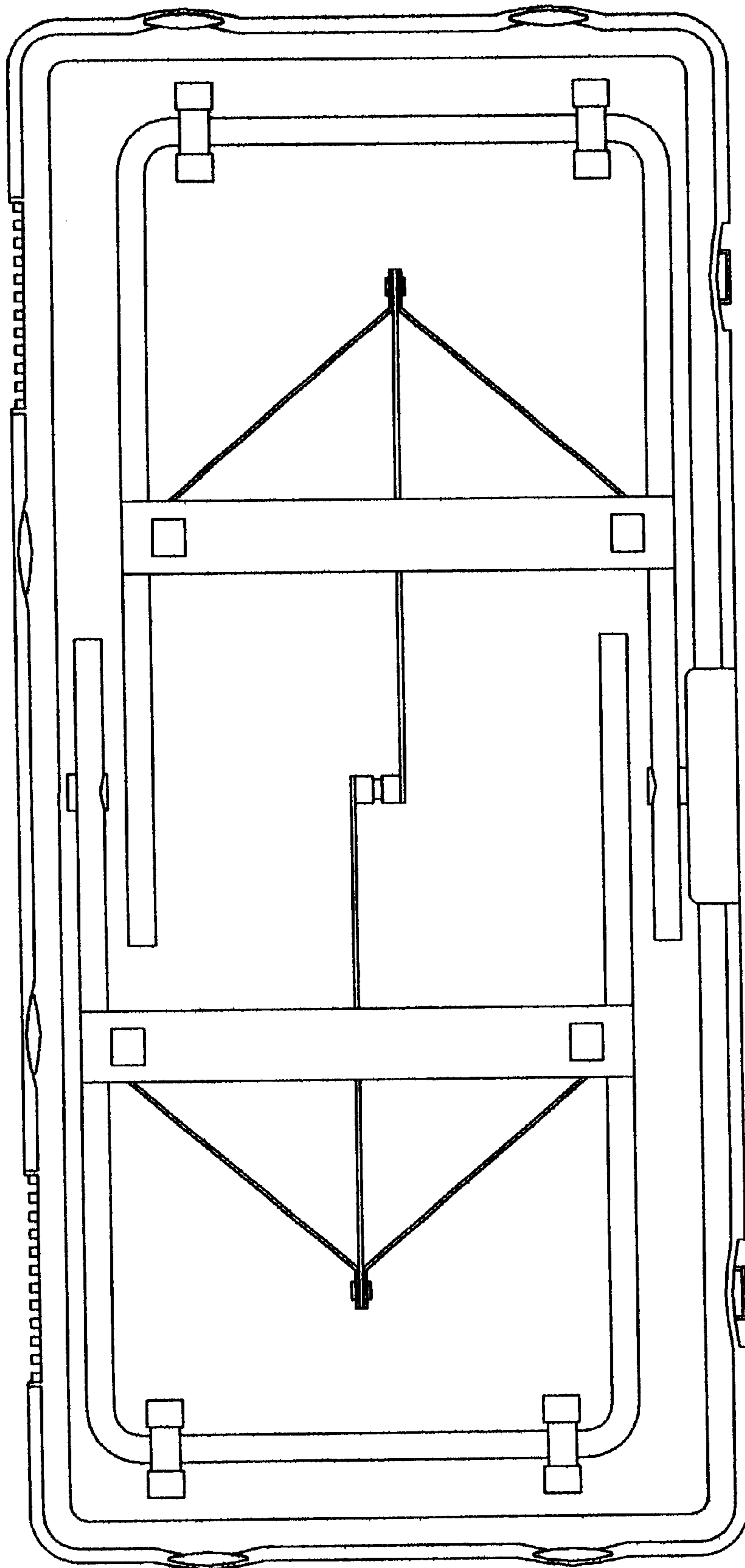

Figure 5



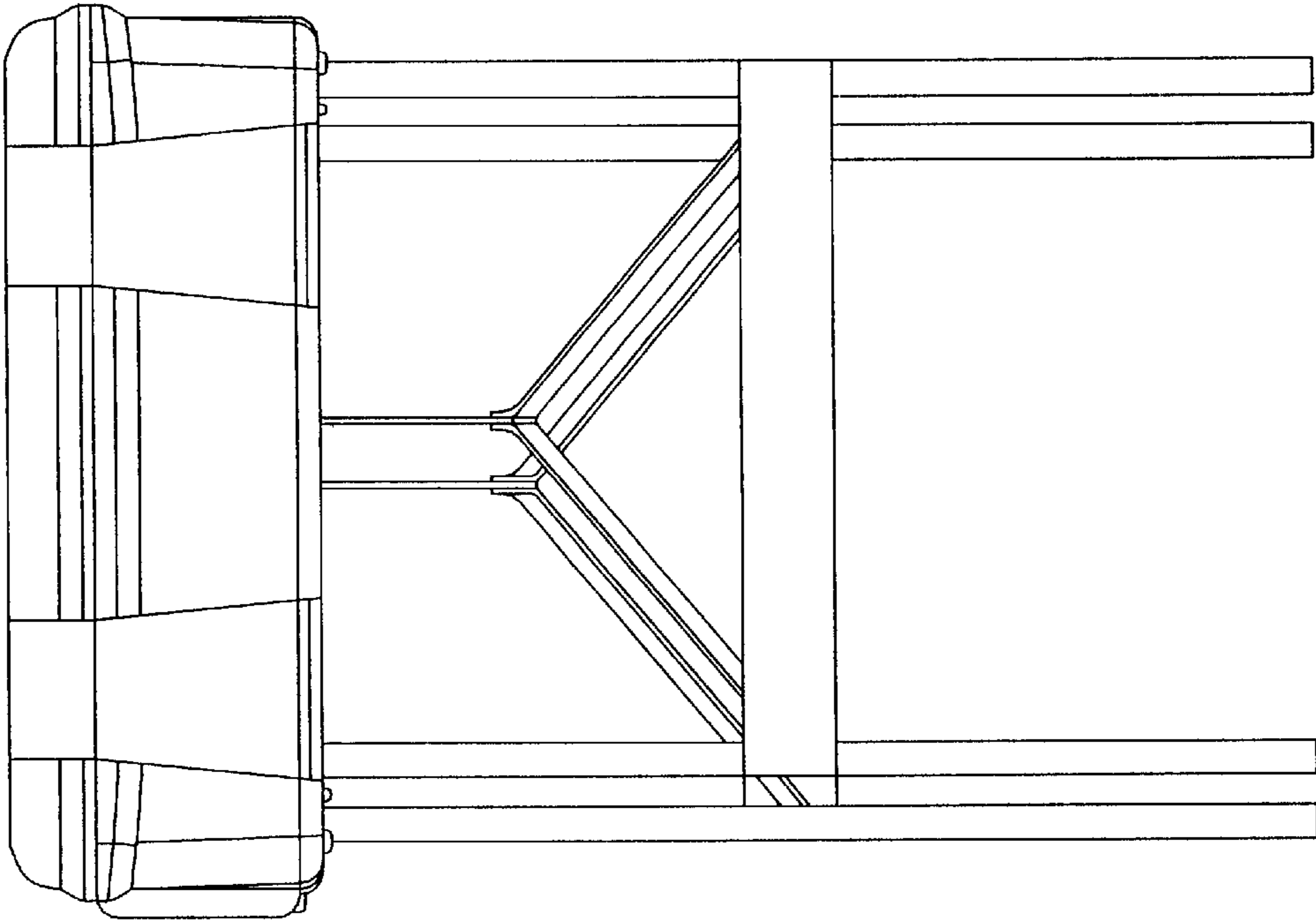

Figure 6