



US00D539555S

(12) **United States Design Patent**
Kita

(10) **Patent No.:** **US D539,555 S**
(45) **Date of Patent:** **** Apr. 3, 2007**

(54) **MESSAGE CHAIR**

(75) Inventor: **Toshiyuki Kita**, Nishinomiya (JP)

(73) Assignee: **Family Co., Ltd.**, Osaka (JP)

(**) Term: **14 Years**

(21) Appl. No.: **29/240,178**

(22) Filed: **Oct. 6, 2005**

(30) **Foreign Application Priority Data**

Apr. 8, 2005 (JP) 2005-010629

(51) **LOC (8) Cl.** **06-01**

(52) **U.S. Cl.** **D6/367**

(58) **Field of Classification Search** D6/334-336,
D6/360, 361, 367, 371, 373, 379, 500-502;
297/68, 271.1, 271.2, 271.3, 411.45, 423.19,
297/423.3, 353, 354.1; 601/49, 57-59, 97-99,
601/102, 115, 116, 148, 149

See application file for complete search history.

(56) **References Cited**

U.S. PATENT DOCUMENTS

D182,804 S * 5/1958 Glass D6/360
D182,805 S * 5/1958 Glass D6/360
D372,801 S * 8/1996 Fujimoto et al. D6/367

(Continued)

Primary Examiner—Mimosa De

(74) *Attorney, Agent, or Firm*—Alleman Hall McCoy
Russell & Tuttle LLP

(57) **CLAIM**

The ornamental design for a massage chair, as shown and described.

DESCRIPTION

FIG. 1 is a front view of a massage chair of the present invention.

FIG. 2 is a rear view of the massage chair of FIG. 1.

FIG. 3 is a top view of the massage chair of FIG. 1.

FIG. 4 is a bottom view of the massage chair of FIG. 1.

FIG. 5 is a left side view of the massage chair of FIG. 1. The right side is a mirror image of the left side.

FIG. 6 is a front view of the massage chair of FIG. 1, shown with air bags inflated.

FIG. 7 is a rear view of the massage chair of FIG. 1, shown with air bags inflated.

FIG. 8 is a top view of the massage chair of FIG. 1, shown with air bags inflated.

FIG. 9 is a bottom view of the massage chair of FIG. 1, shown with air bags inflated.

FIG. 10 is a left side view of the massage chair of FIG. 1, shown with air bags inflated. The right side view with the air bags inflated is a mirror image of the left side view with the air bags inflated.

FIG. 11 is a left side view of the massage chair of FIG. 1, shown with a backrest portion reclined and a footrest portion raised.

FIG. 12 is a top view of the massage chair of FIG. 1, shown with speaker portions turned inward.

FIG. 13 is a left side view of the massage chair of FIG. 1, shown with a headrest portion raised.

FIG. 14 is a front view of a detachable left armrest portion of the massage chair of FIG. 1. The detachable right armrest portion of the massage chair is symmetrical to the detachable left armrest portion.

FIG. 15 is a rear view of the detachable left armrest portion of the massage chair of FIG. 1.

FIG. 16 is a top view of the detachable left armrest portion of the massage chair of FIG. 1.

FIG. 17 is a bottom view of the detachable left armrest portion of the massage chair of FIG. 1.

FIG. 18 is a left side view of the detachable left armrest portion of the massage chair of FIG. 1.

FIG. 19 is a right side view of the detachable left armrest portion of the massage chair of FIG. 1.

FIG. 20 is a perspective view of the massage chair of FIG. 1, shown with detachable right and left armrest portions removed; and,

FIG. 21 is a perspective view of the massage chair of FIG. 1.

The armrests in FIGS. 14-19 are shown separately for easy of illustration.

1 Claim, 9 Drawing Sheets

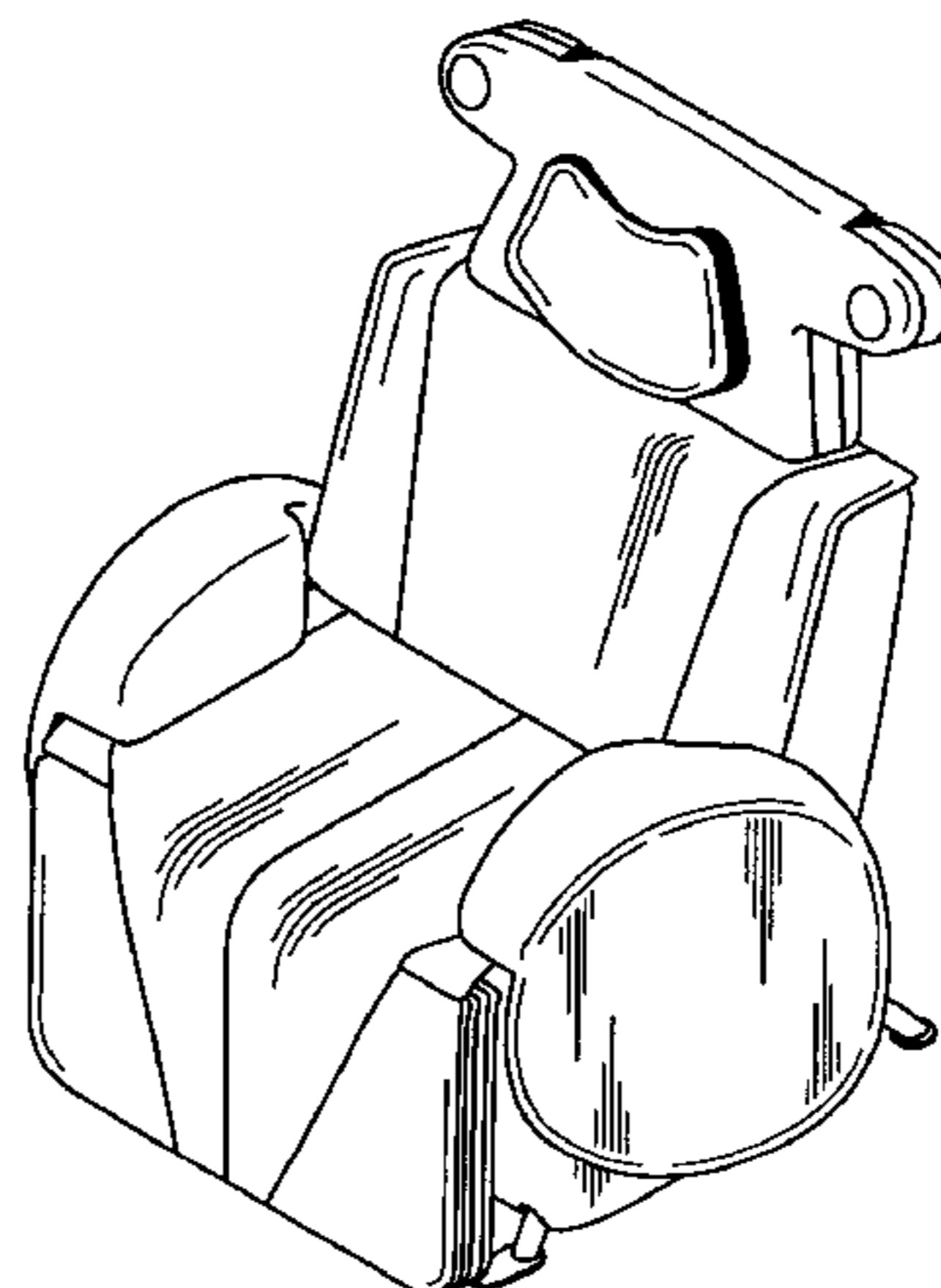
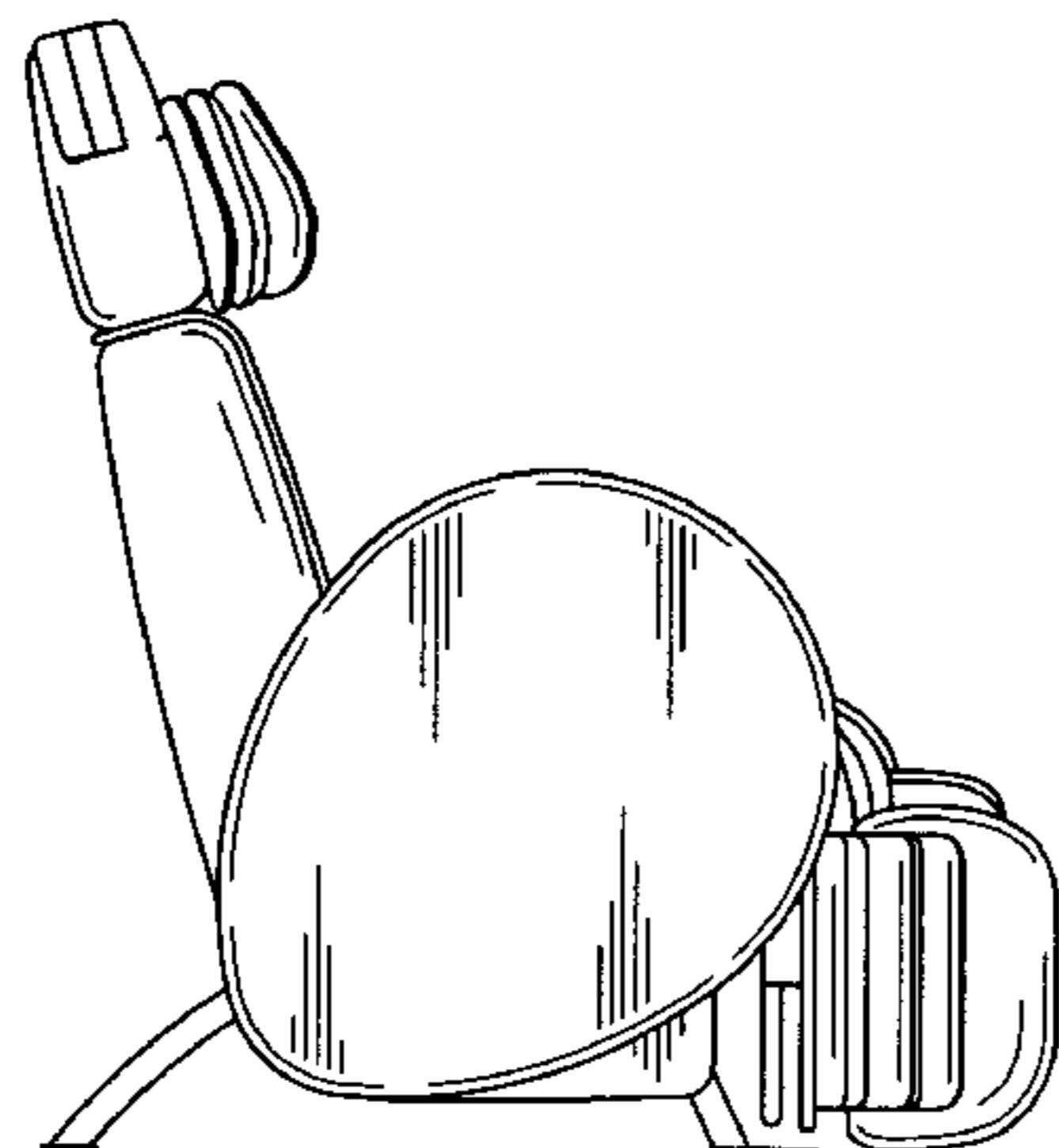

US D539,555 S

Page 2

U.S. PATENT DOCUMENTS

D372,802 S *	8/1996	Fujimoto et al.	D6/367	D498,065 S *	11/2004	Potter	D6/335
5,762,618 A *	6/1998	Yamanaka et al.	601/148	D502,607 S *	3/2005	Miyake et al.	D6/335
D462,183 S *	9/2002	Canto Garcia	D6/335	D502,817 S *	3/2005	Inada et al.	D6/367
D471,372 S *	3/2003	Inada et al.	D6/367	D517,338 S *	3/2006	Inada et al.	D6/367

* cited by examiner

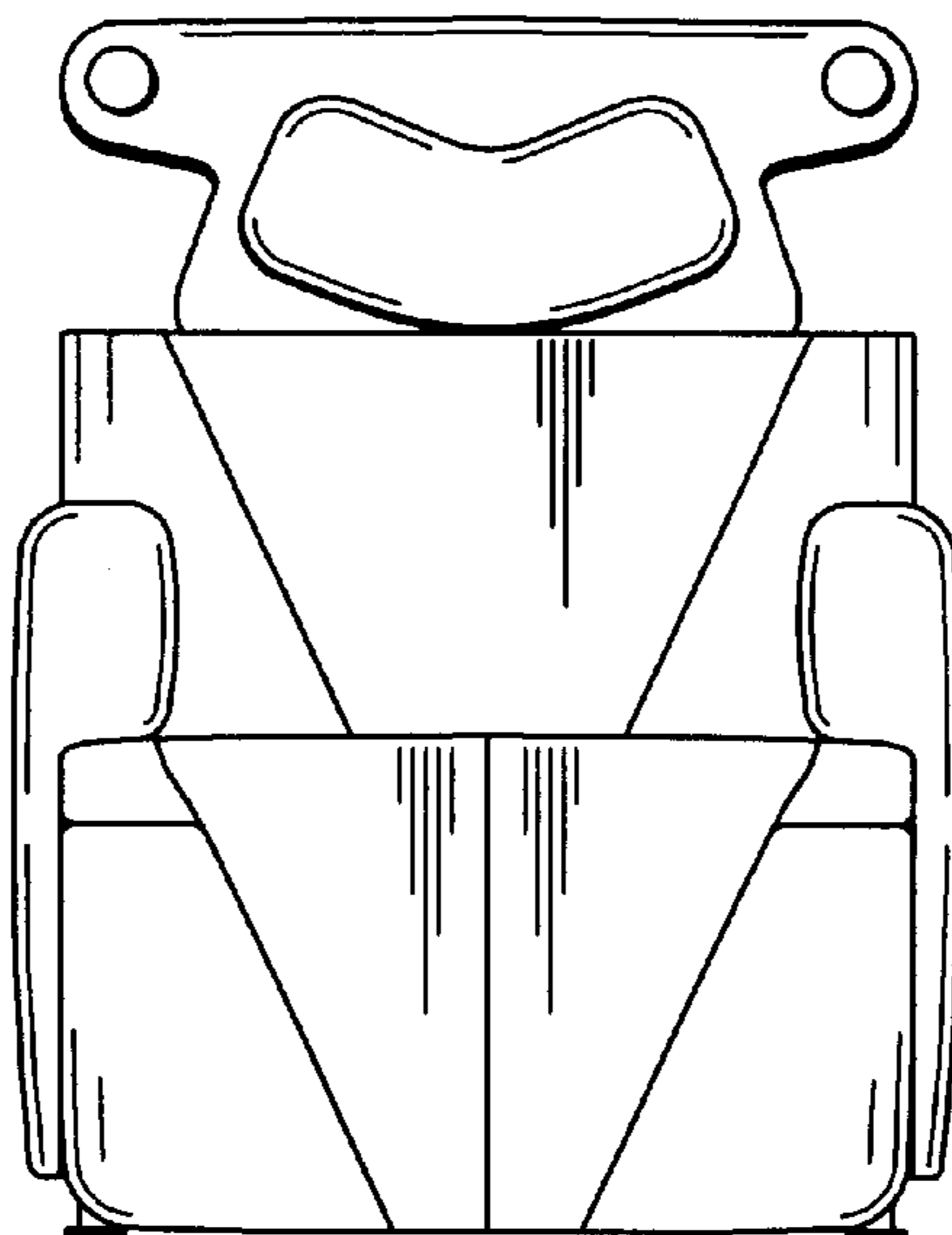

FIG. 1

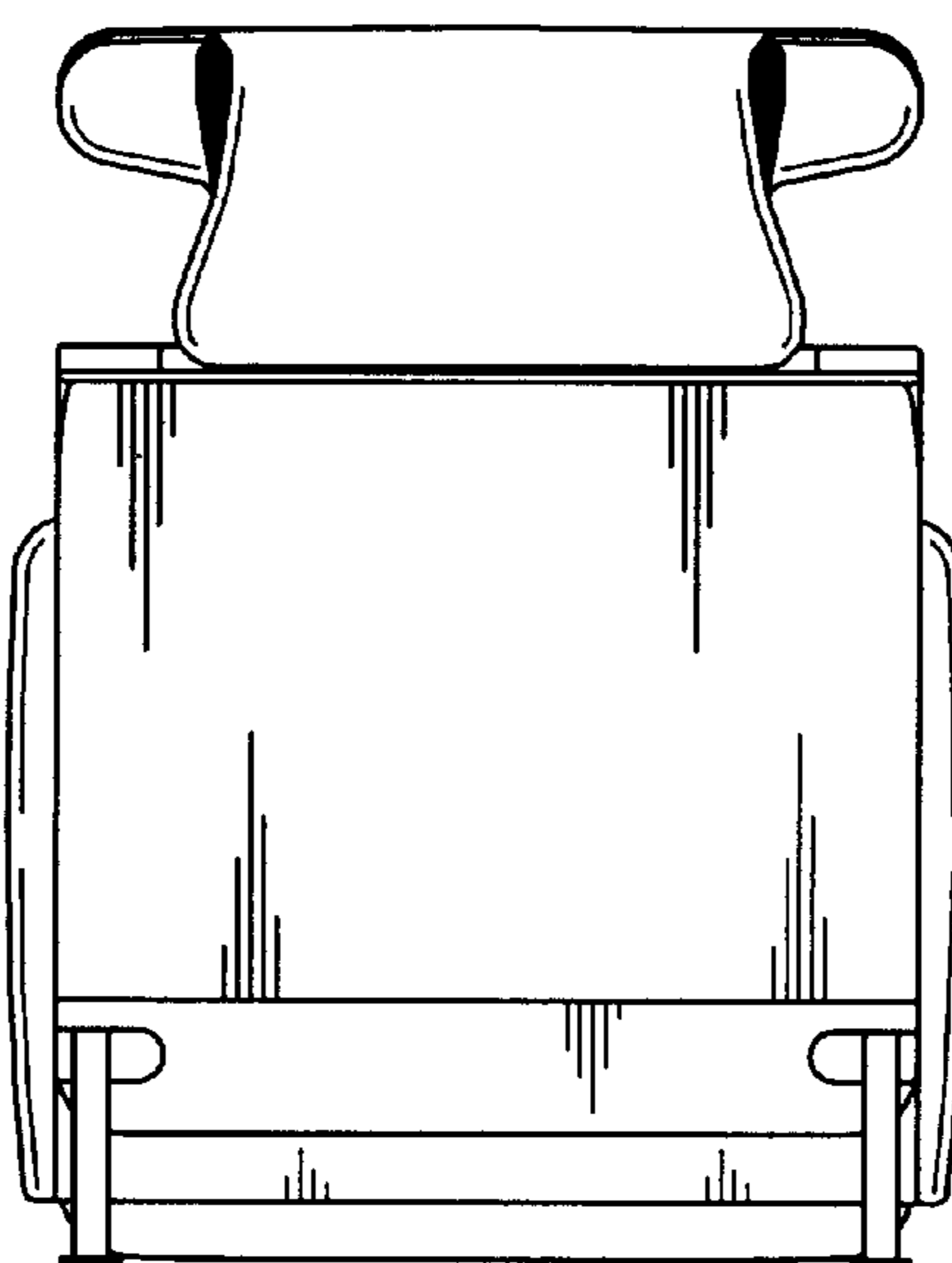

FIG. 2

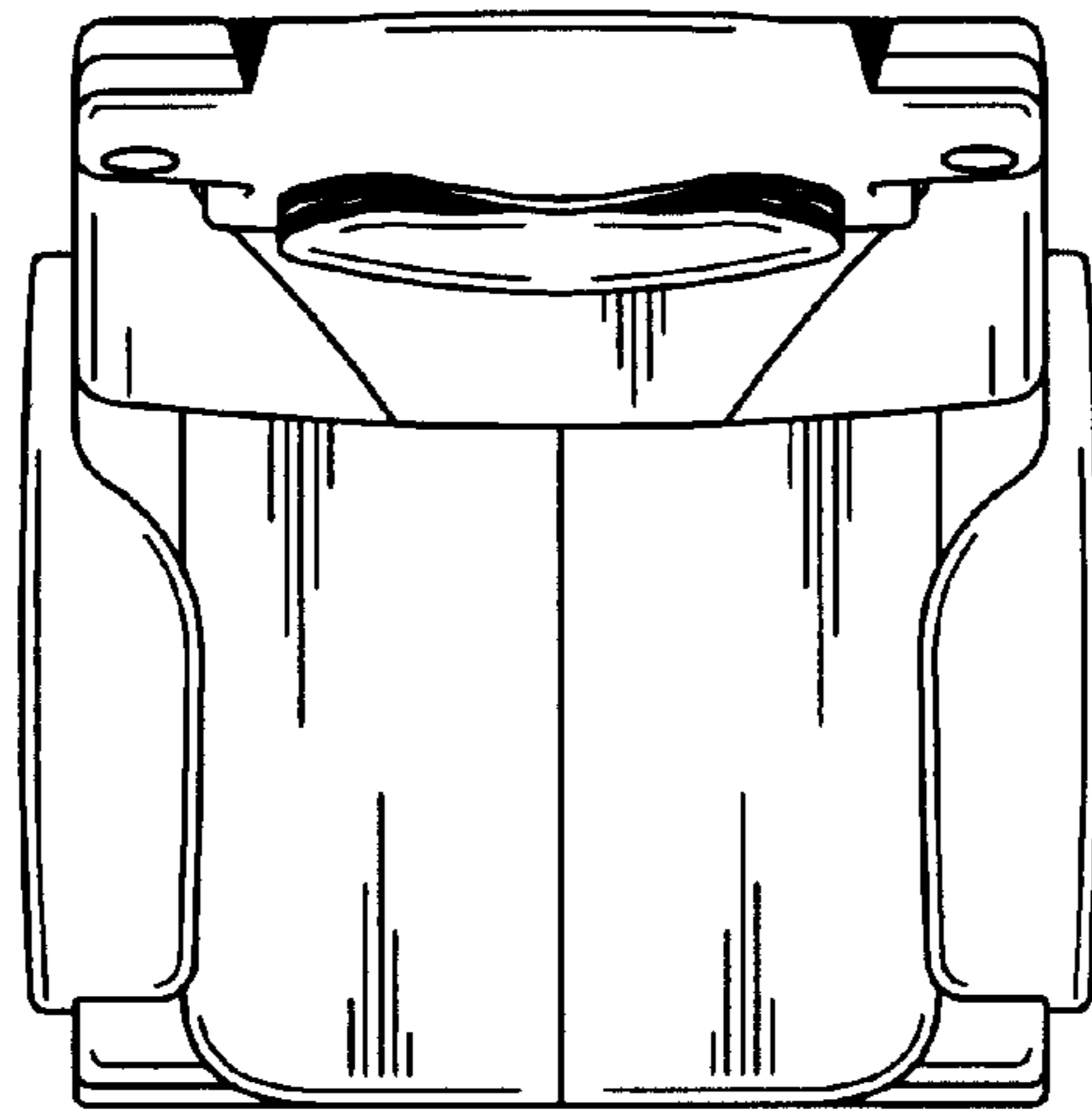

FIG. 3

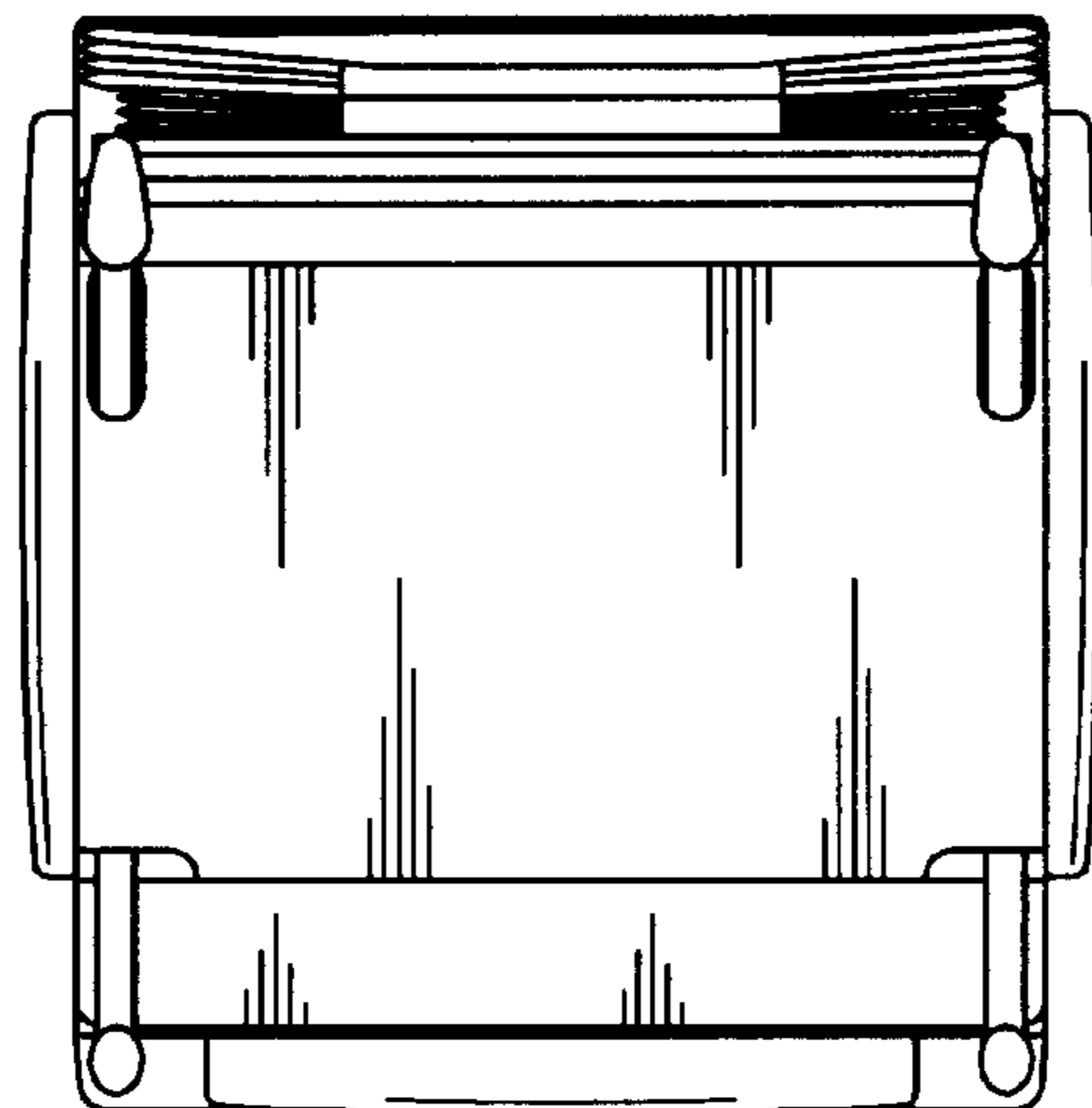

FIG. 4

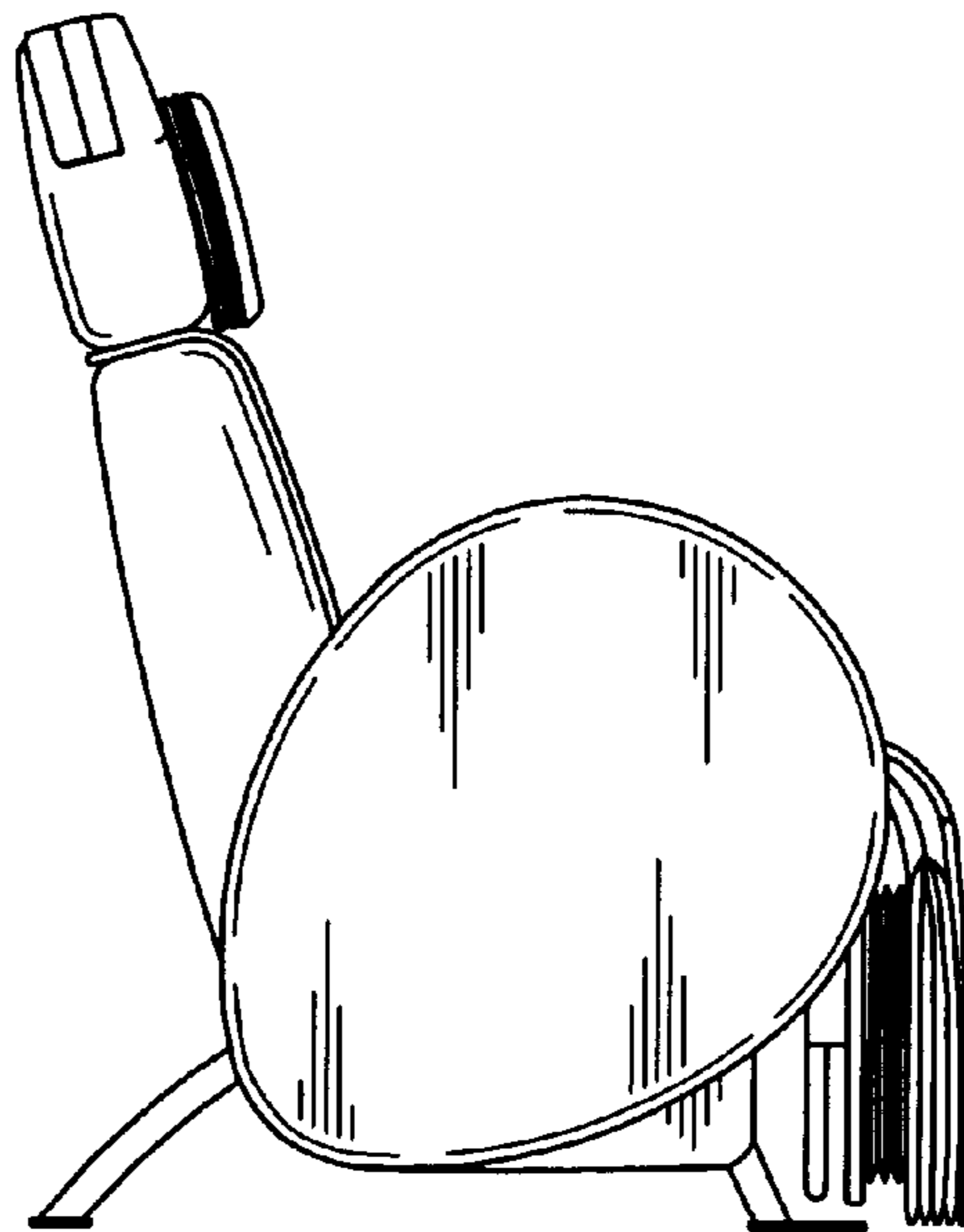

FIG. 5

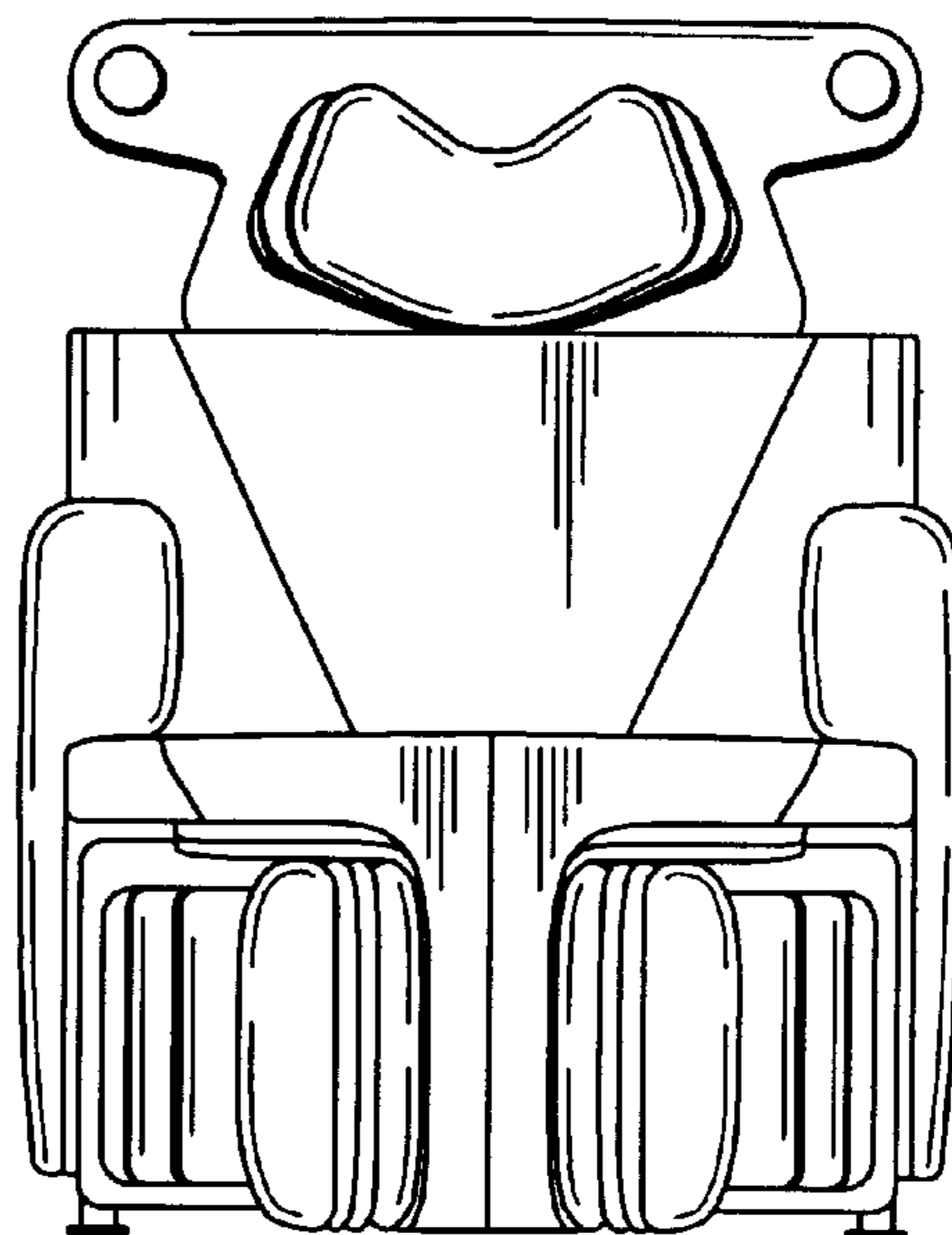

FIG. 6

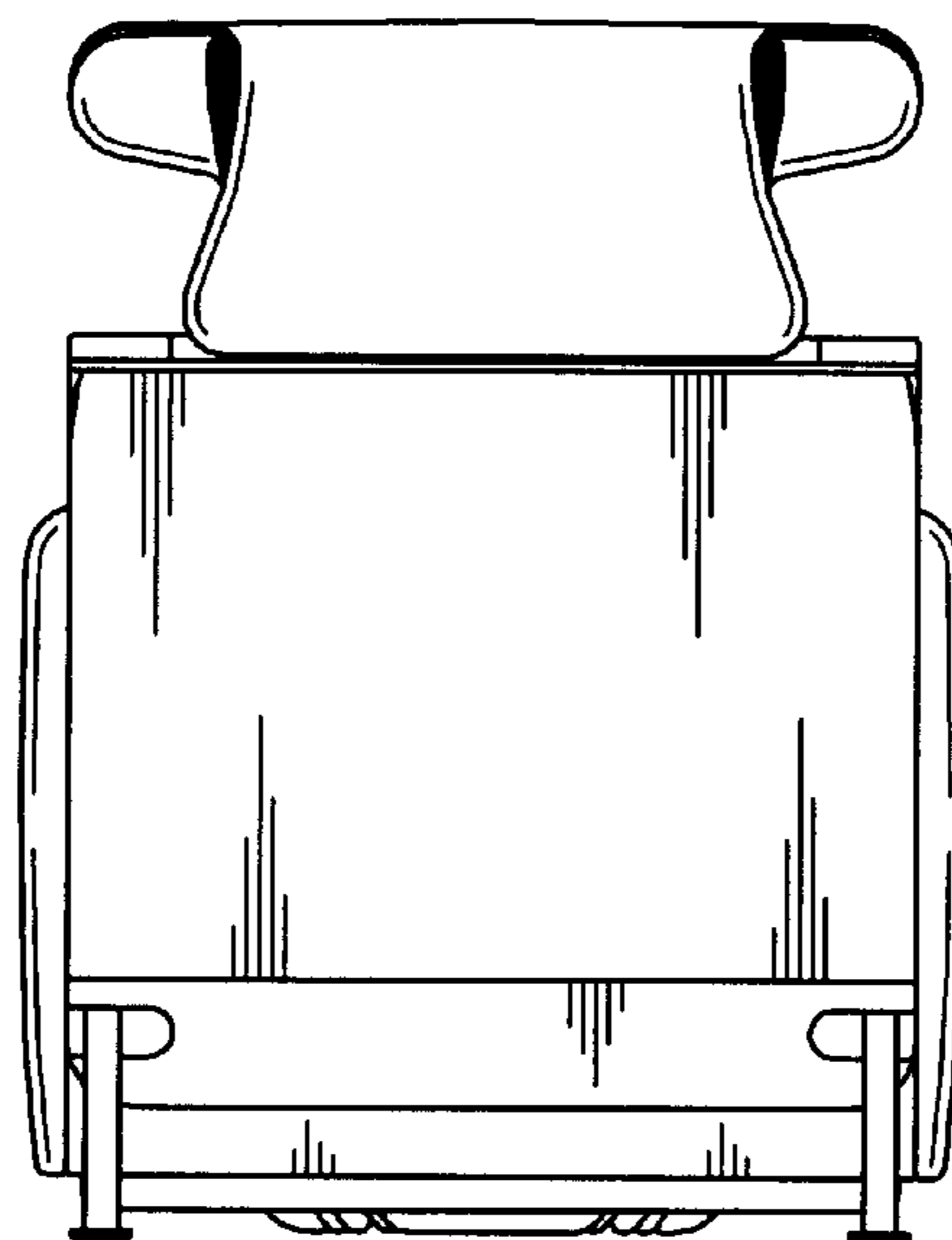

FIG. 7

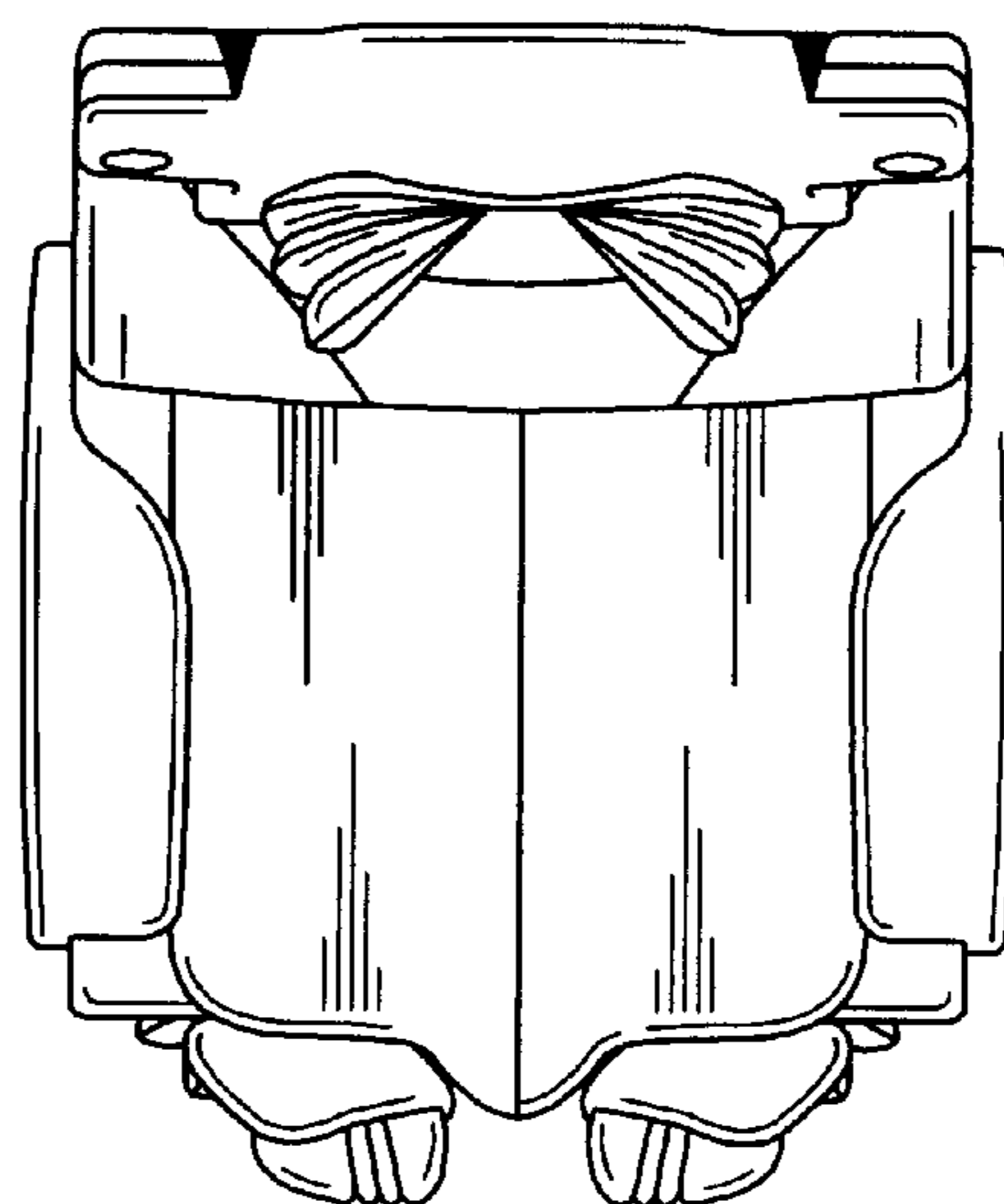

FIG. 8

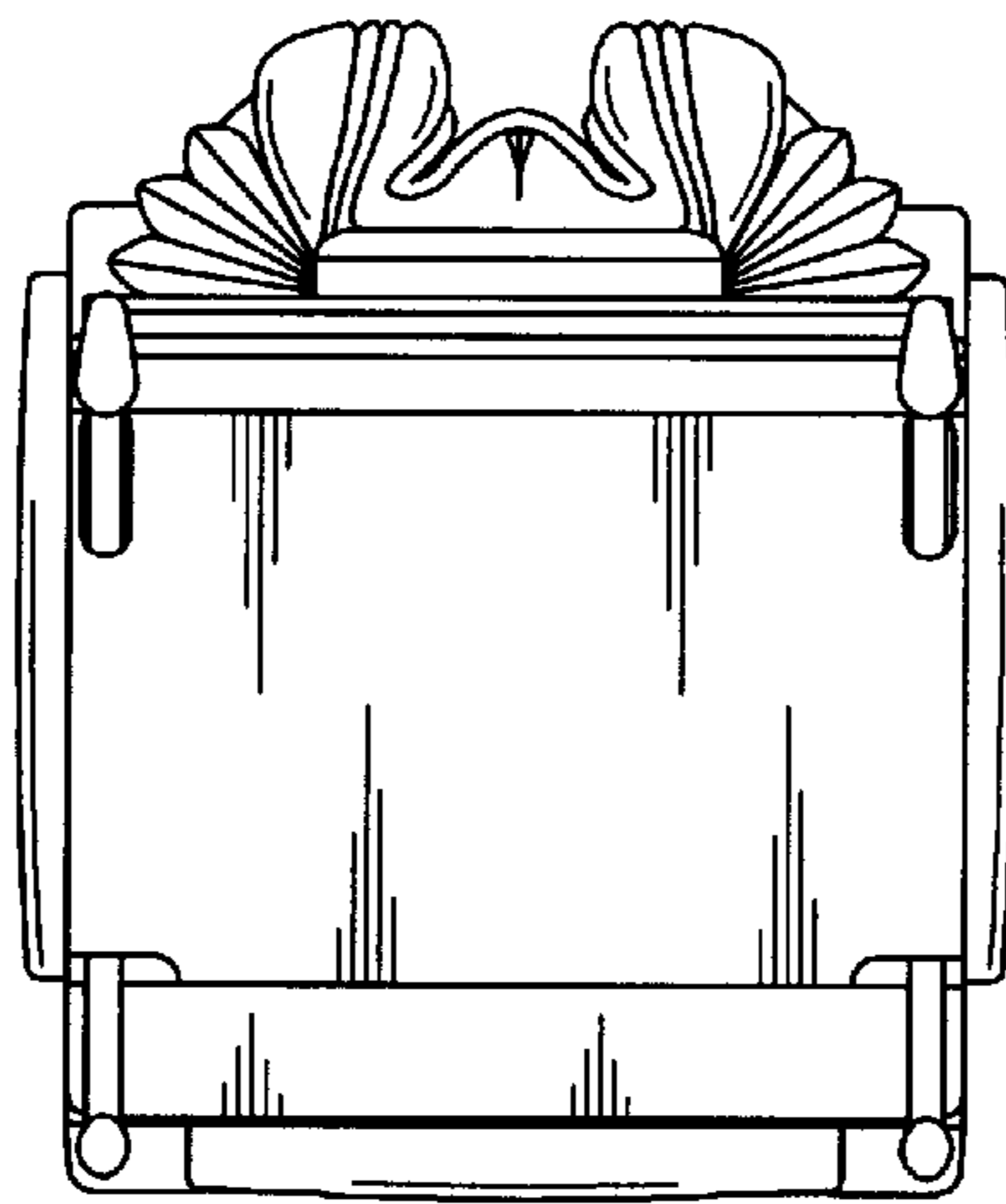

FIG. 9

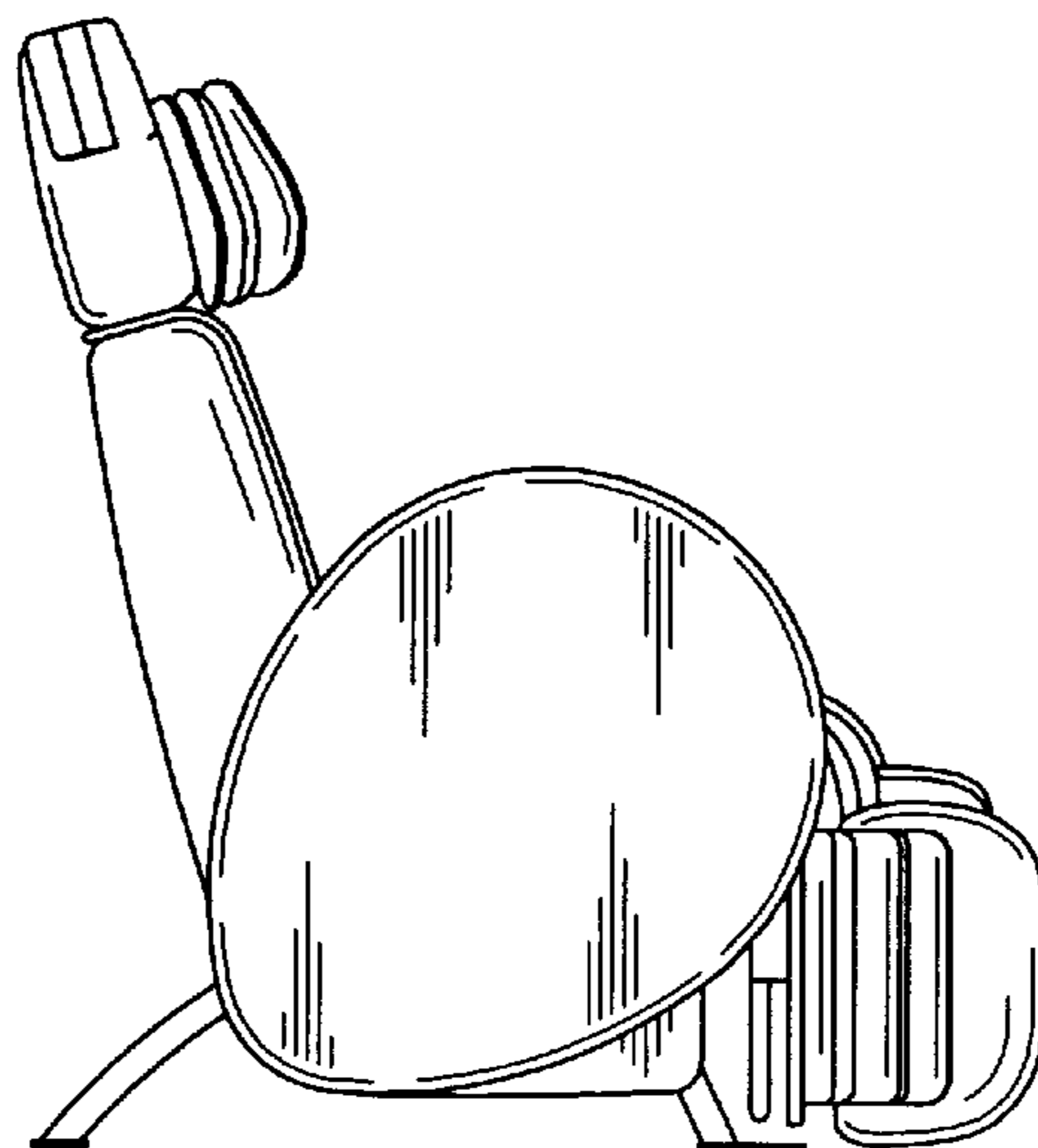

FIG. 10

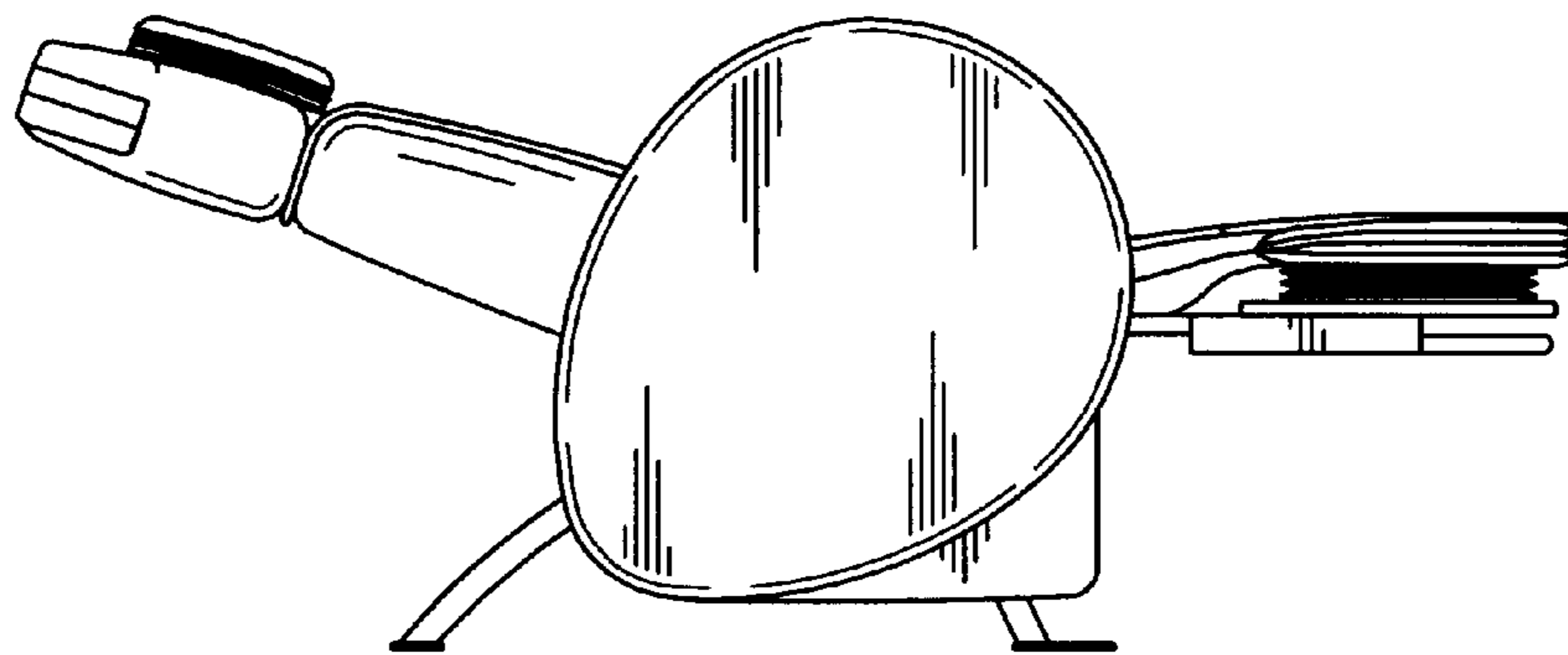

FIG. 11

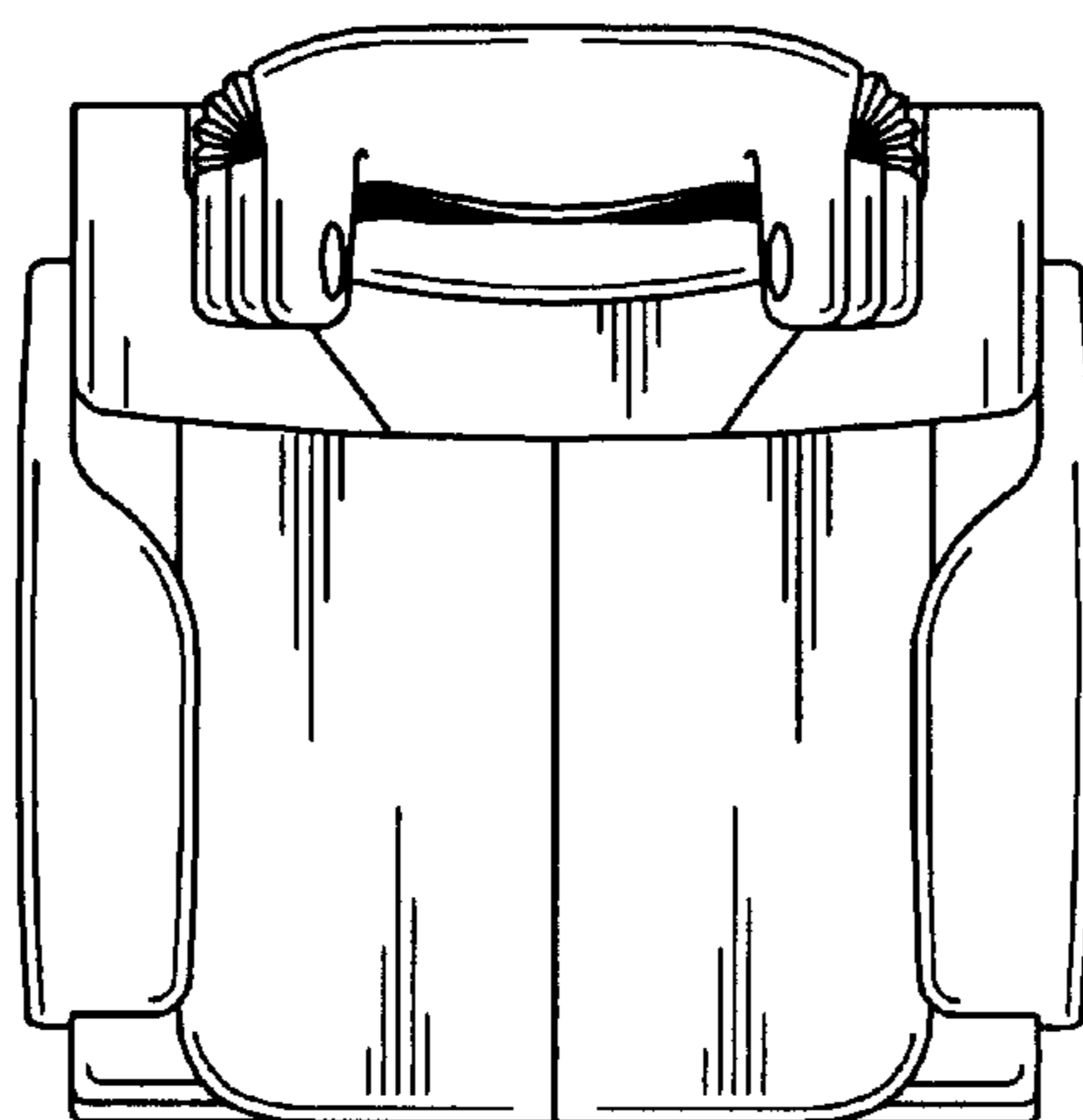

FIG. 12

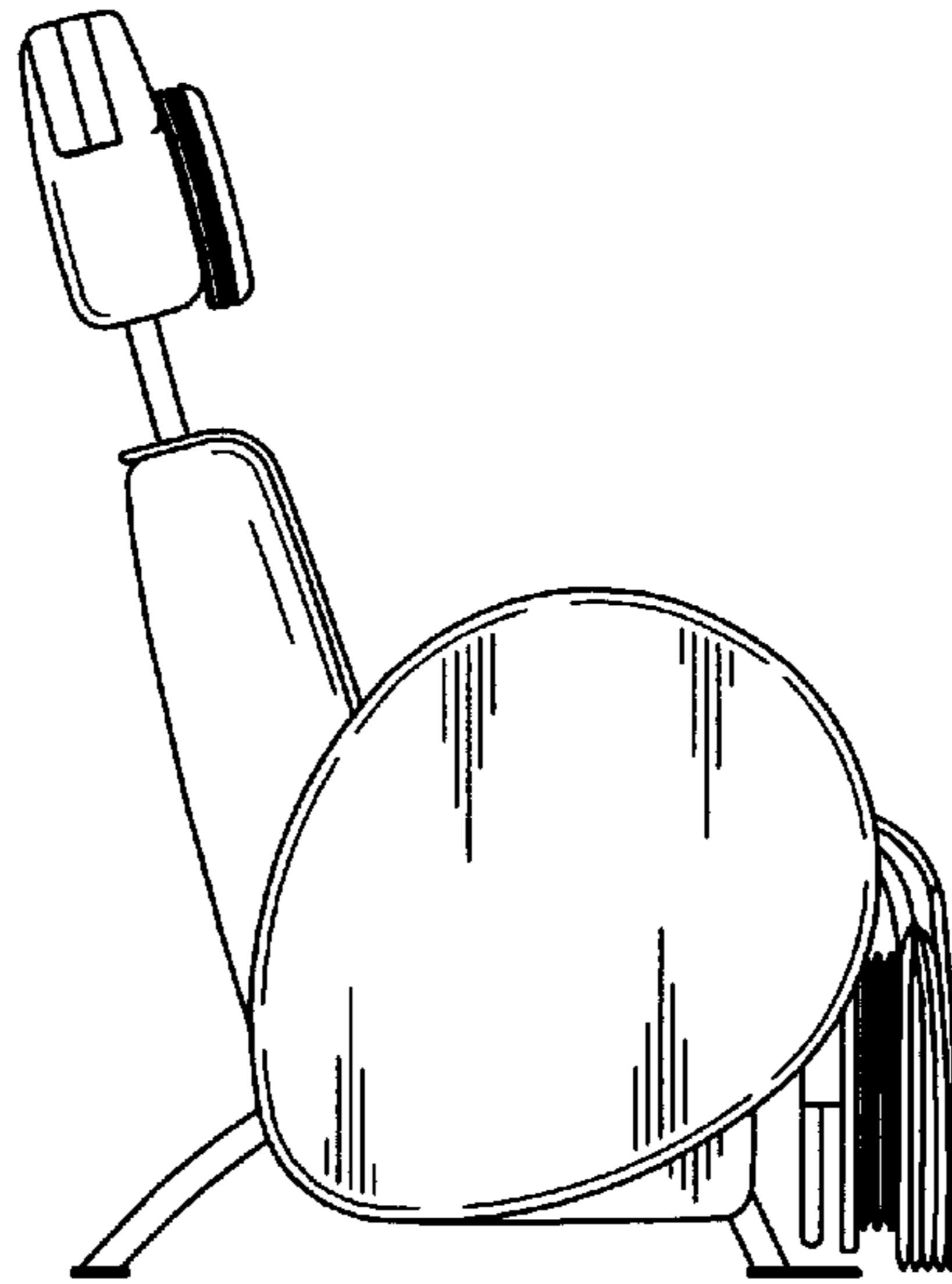

FIG. 13

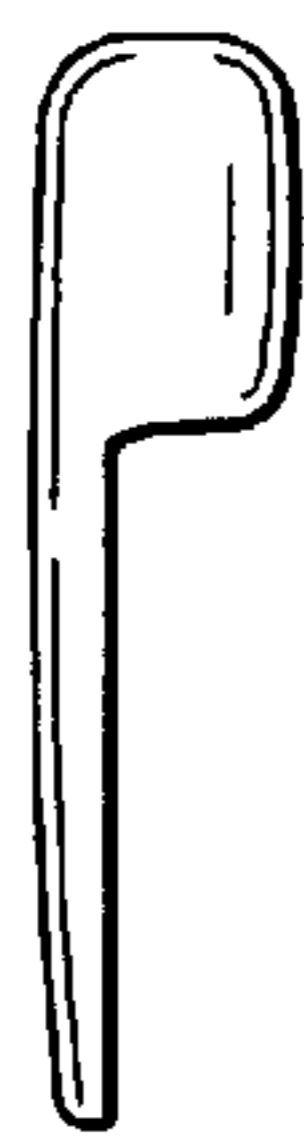

FIG. 14



FIG. 15



FIG. 16

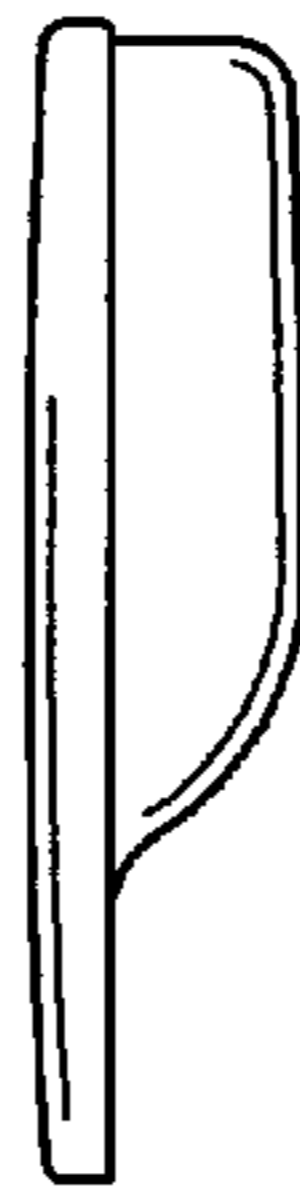

FIG. 17

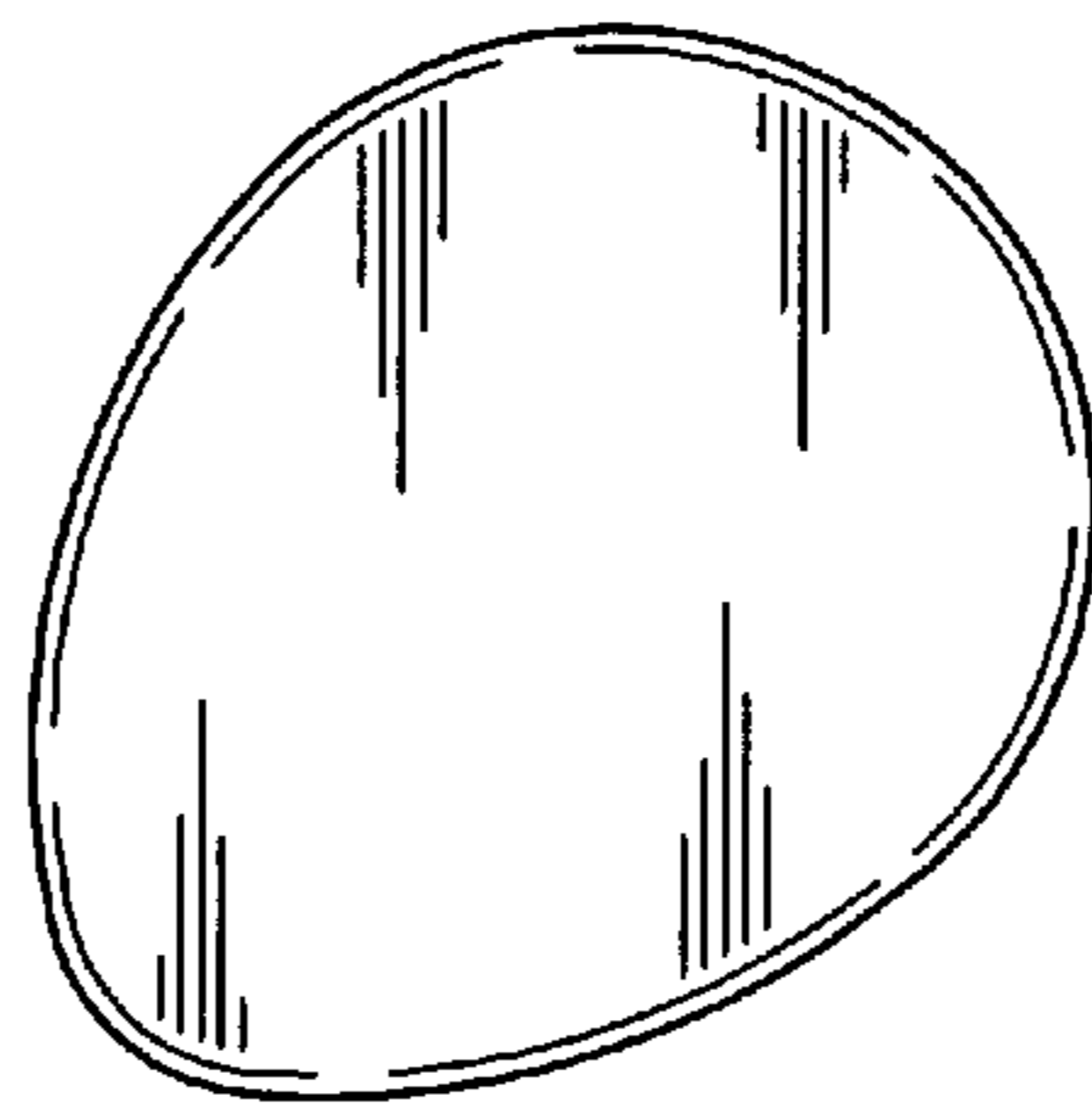

FIG. 18

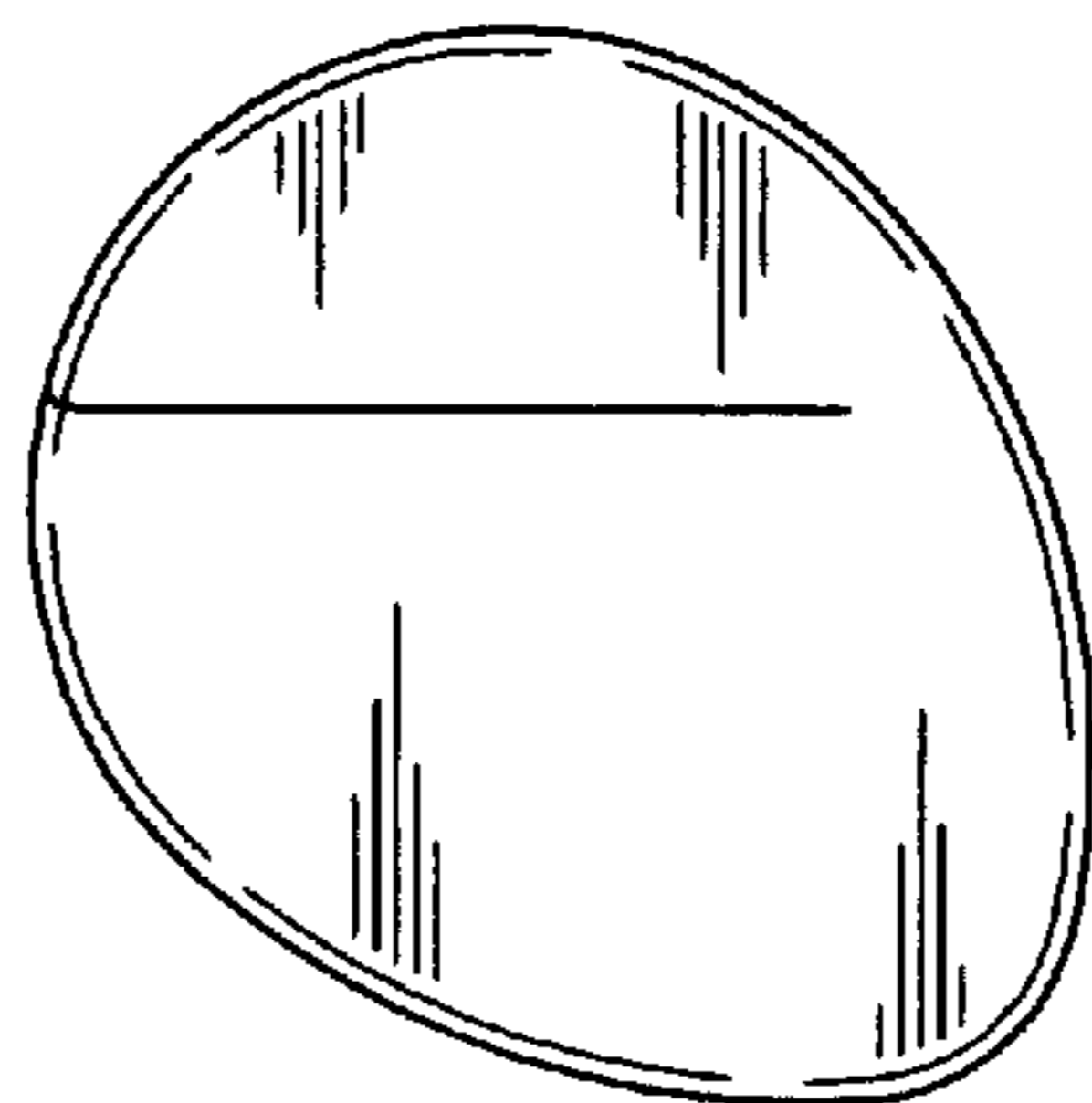

FIG. 19

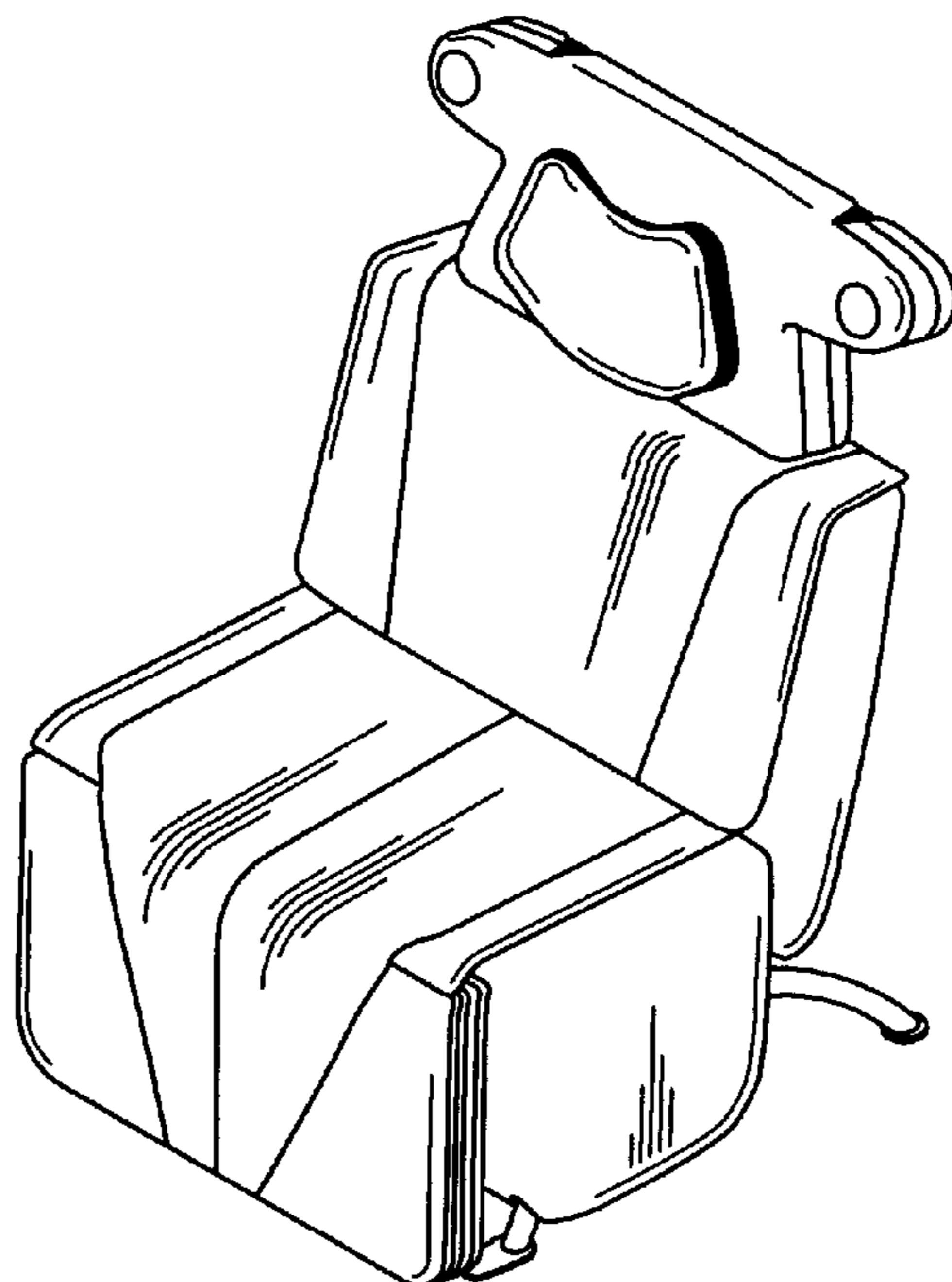

FIG. 20

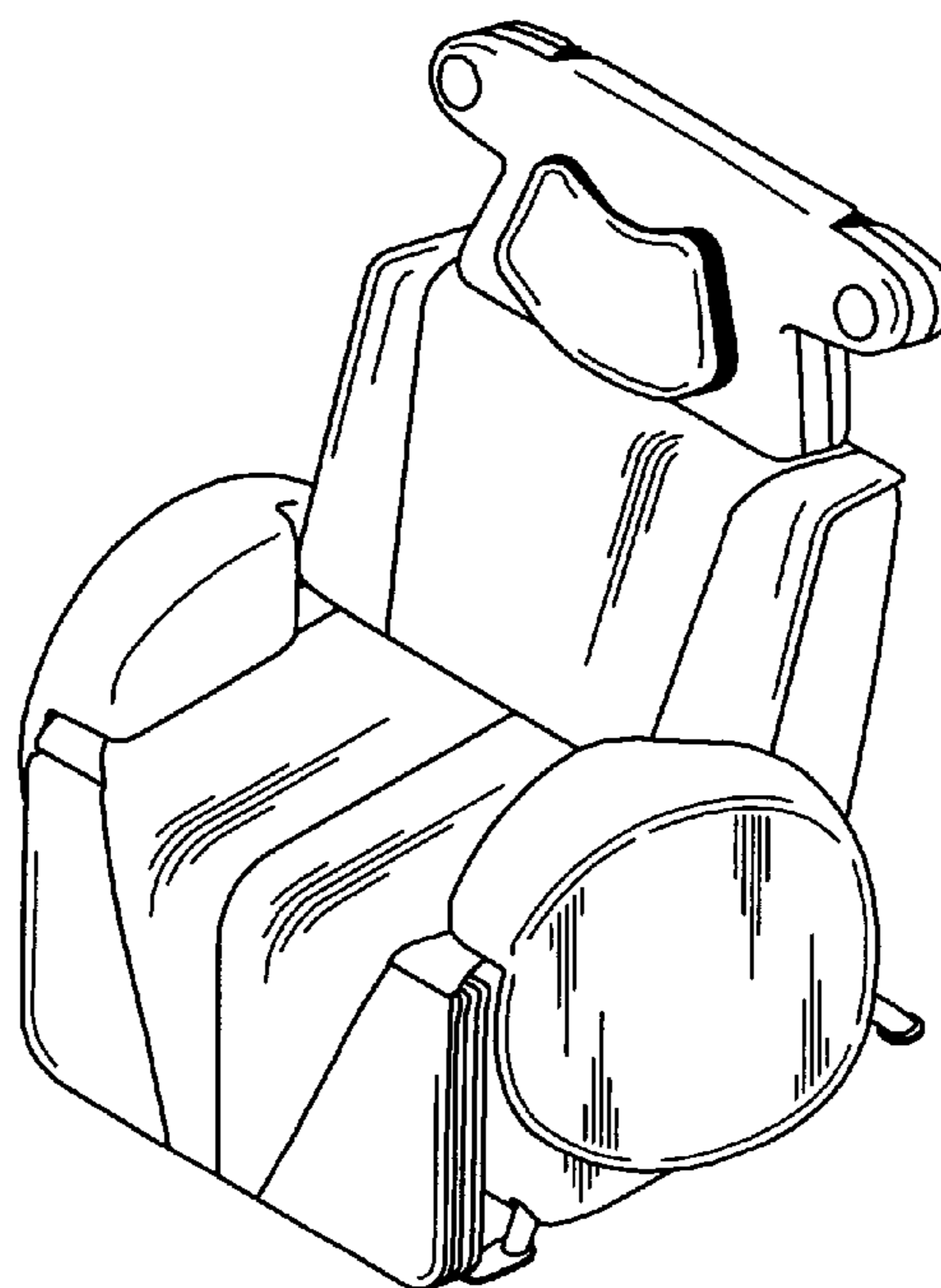

FIG. 21