



US00D539354S

(12) **United States Design Patent**
Mak

(10) **Patent No.:** **US D539,354 S**

(45) **Date of Patent:** **** Mar. 27, 2007**

(54) **HOUSING FOR AN ELECTRONIC GAME APPARATUS**

(75) Inventor: **Pui See (Stephine) Mak**, Hong Kong (HK)

(73) Assignee: **VTech Electronics, Ltd.**, Hong Kong (HK)

(**) Term: **14 Years**

(21) Appl. No.: **29/237,715**

(22) Filed: **Sep. 6, 2005**

(51) **LOC (8) Cl.** **21-01**

(52) **U.S. Cl.** **D21/329**

(58) **Field of Classification Search** D21/324,
D21/328, 329, 331, 333; 273/148 B; 463/1,
463/2, 29-35, 46, 47

See application file for complete search history.

(56) **References Cited**

U.S. PATENT DOCUMENTS

5,095,798	A	*	3/1992	Okada et al.	463/35
5,161,803	A	*	11/1992	Ohara	463/44
5,672,108	A	*	9/1997	Lam et al.	463/39
6,042,478	A	*	3/2000	Ng	463/44
D428,938	S	*	8/2000	Tomizawa	D21/329
6,227,966	B1	*	5/2001	Yokoi	463/1

D460,121	S	*	7/2002	Furusato	D21/329
D468,775	S	*	1/2003	Sasaki	D21/329
D473,597	S	*	4/2003	Clark	D21/329
D490,119	S	*	5/2004	Griffin et al.	D21/329
D490,477	S	*	5/2004	Boilen	D21/329

* cited by examiner

Primary Examiner—Prabhakar Deshmukh

(74) *Attorney, Agent, or Firm*—Greenberg Traurig, LLP

(57) **CLAIM**

The ornamental design for housing for an electronic game apparatus, as shown and described.

DESCRIPTION

FIG. 1 is a top plan view of the housing for an electronic game apparatus, showing my new design.

FIG. 2 is a front elevation thereof.

FIG. 3 is a rear elevation thereof.

FIG. 4 is a right side thereof.

FIG. 5 is a left side thereof.

FIG. 6 is a bottom view thereof.

FIG. 7 is left side perspective view thereof.

FIG. 8 is a top, right, rear perspective view thereof.

FIG. 9 is a bottom rear perspective view thereof; and,

FIG. 10 is a bottom, right, rear perspective view thereof.

The broken lines are for illustrative purpose only and form no part of the claimed design.

1 Claim, 8 Drawing Sheets

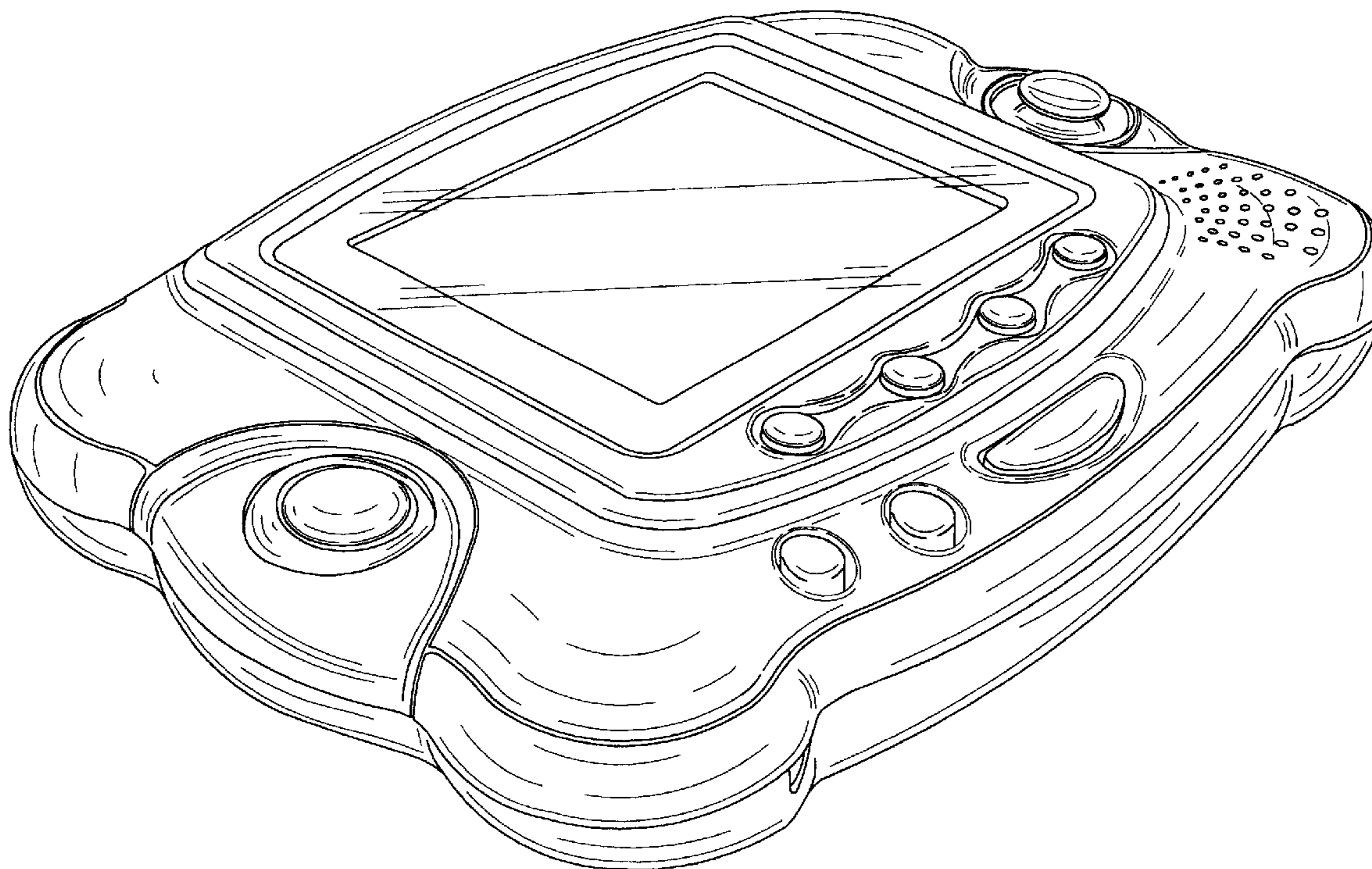

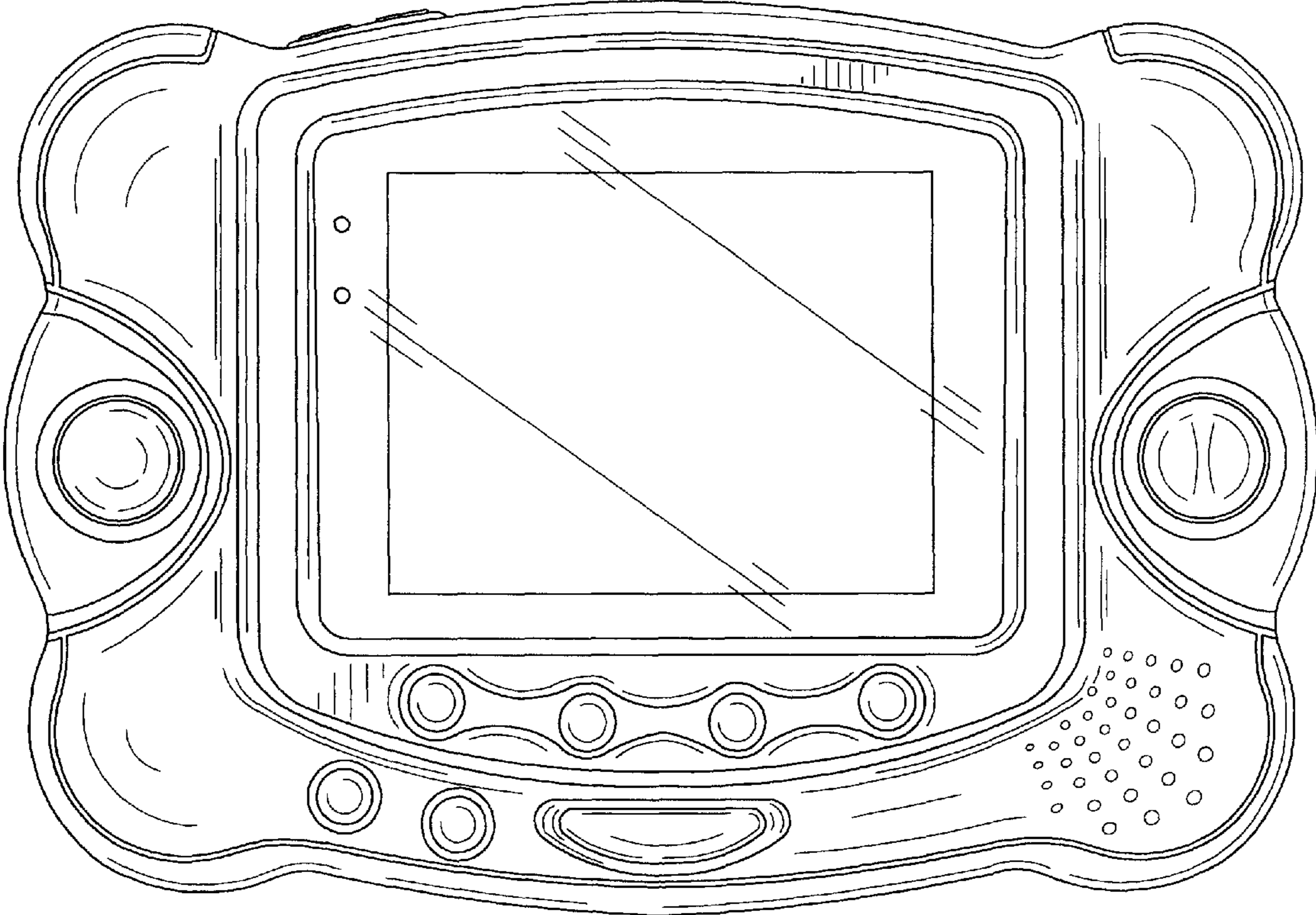

FIG. 1

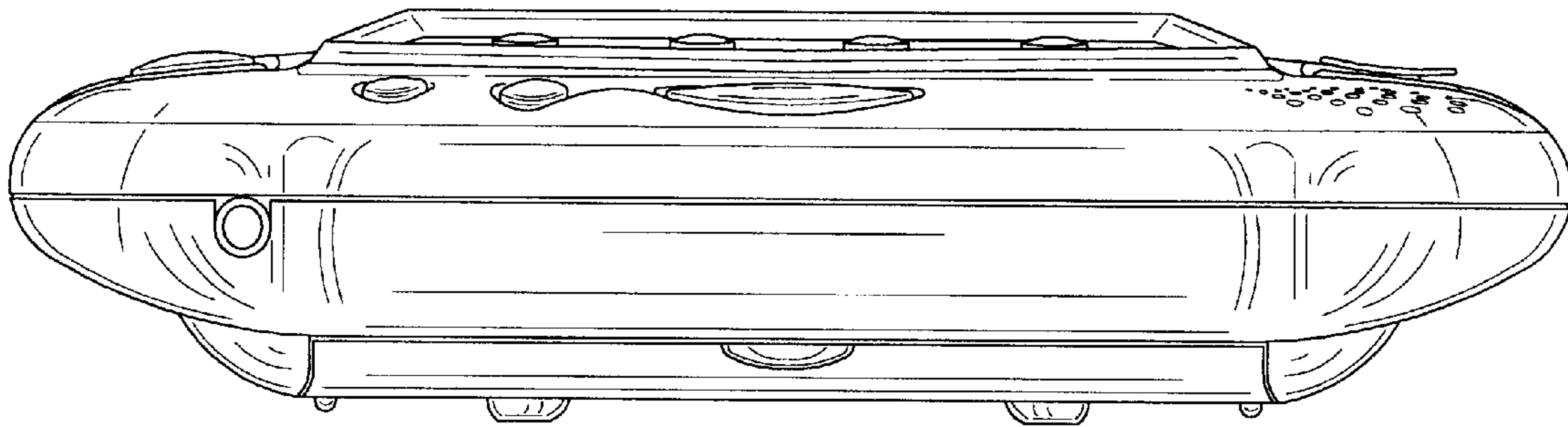

FIG. 2

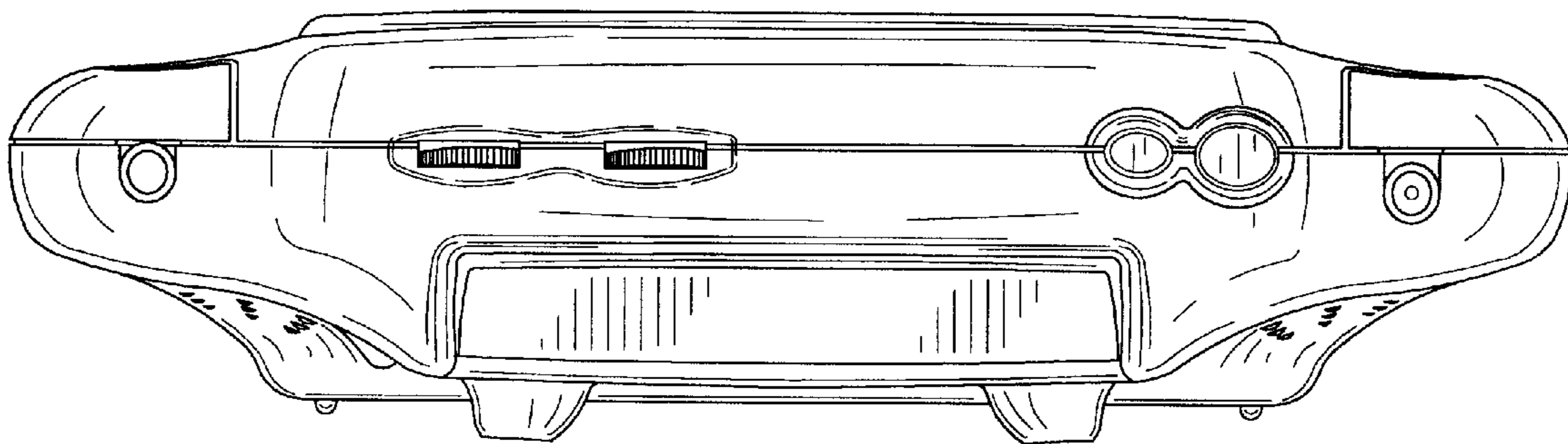

FIG. 3

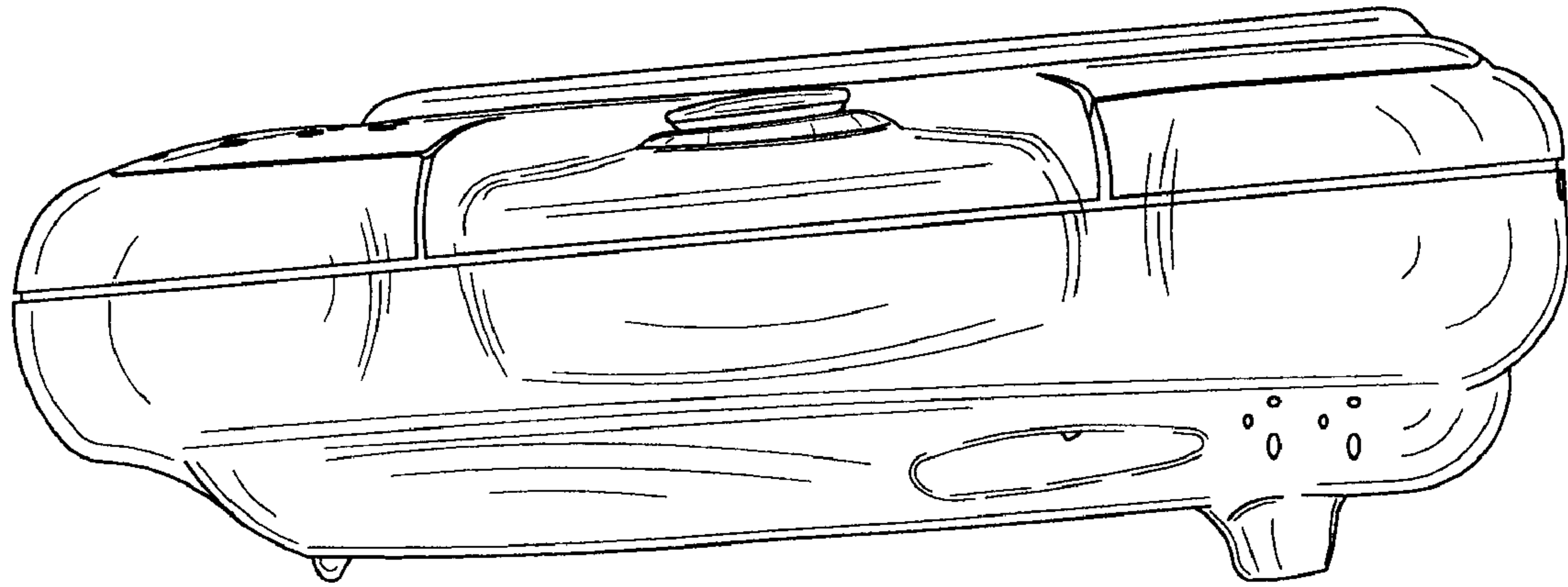

FIG. 4

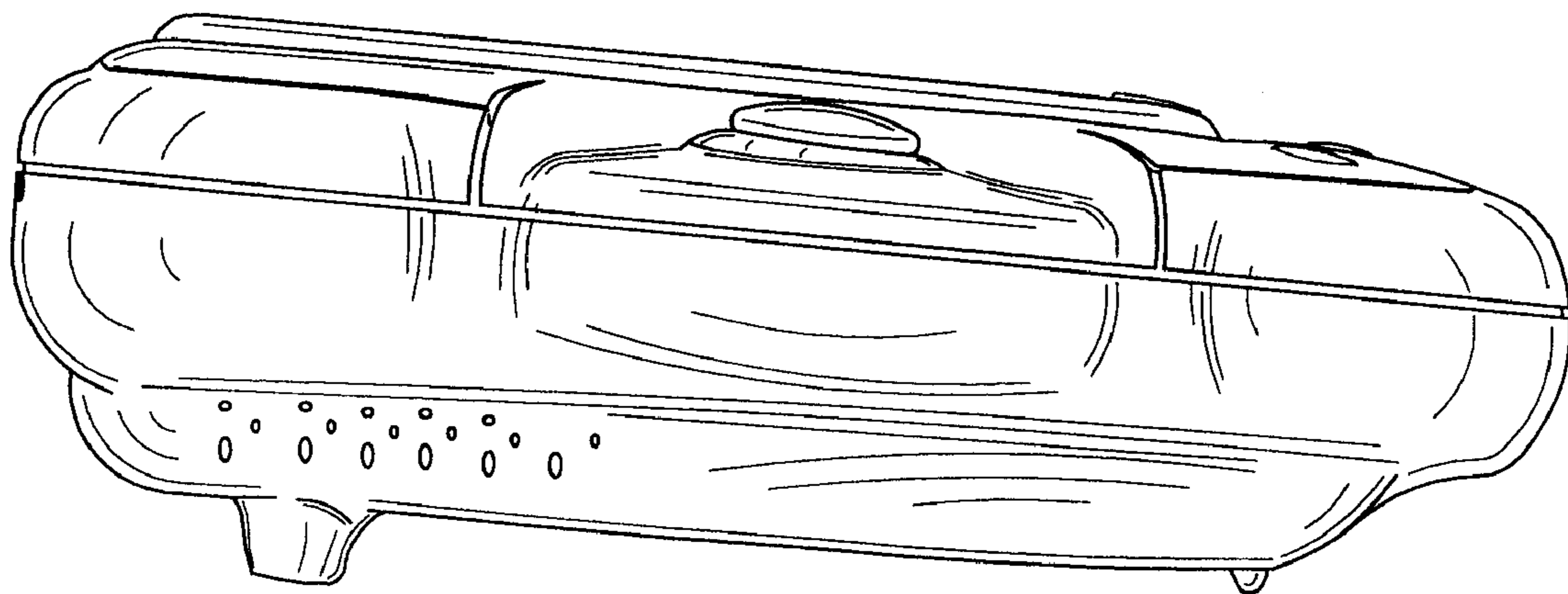

FIG. 5

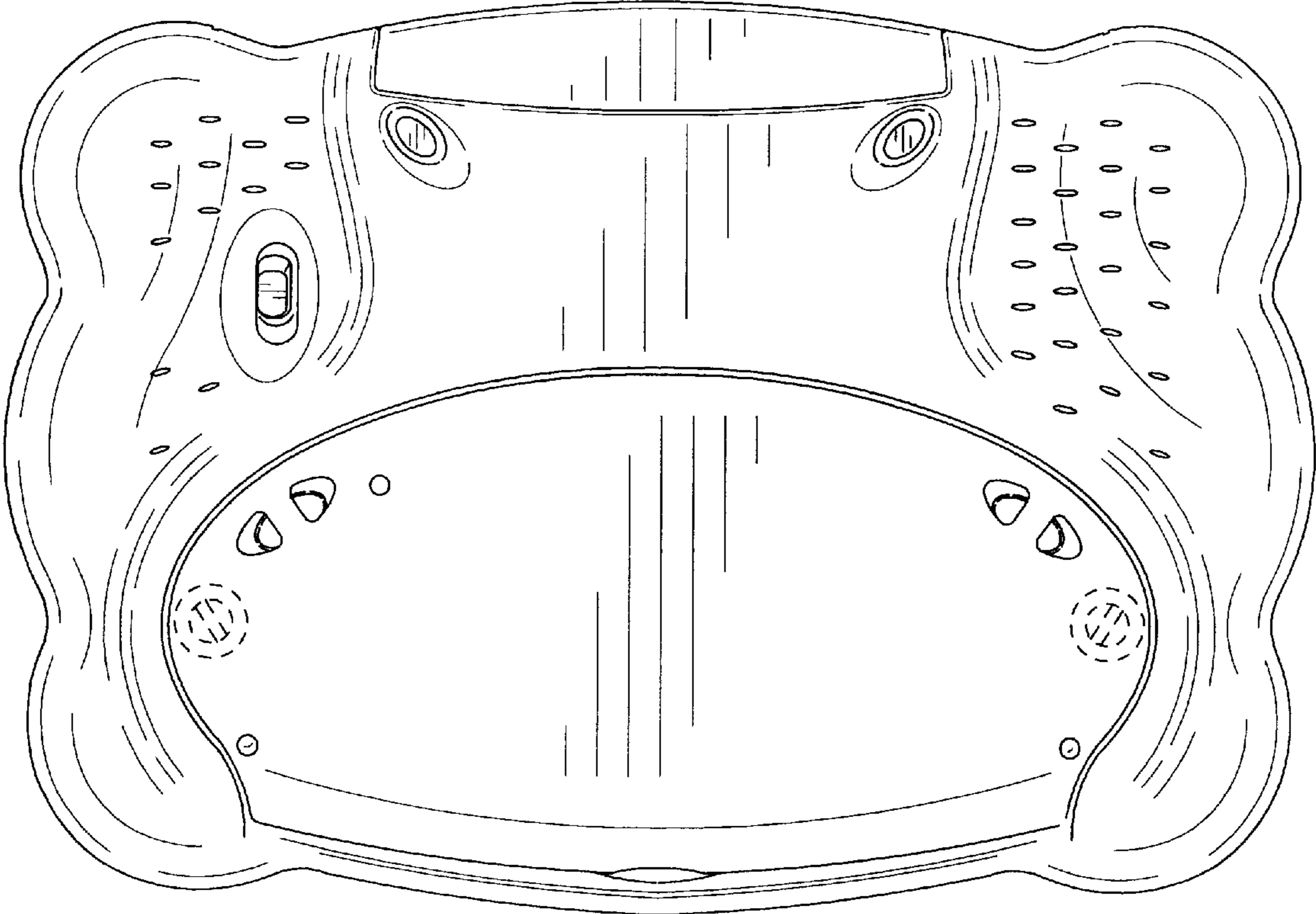

FIG. 6

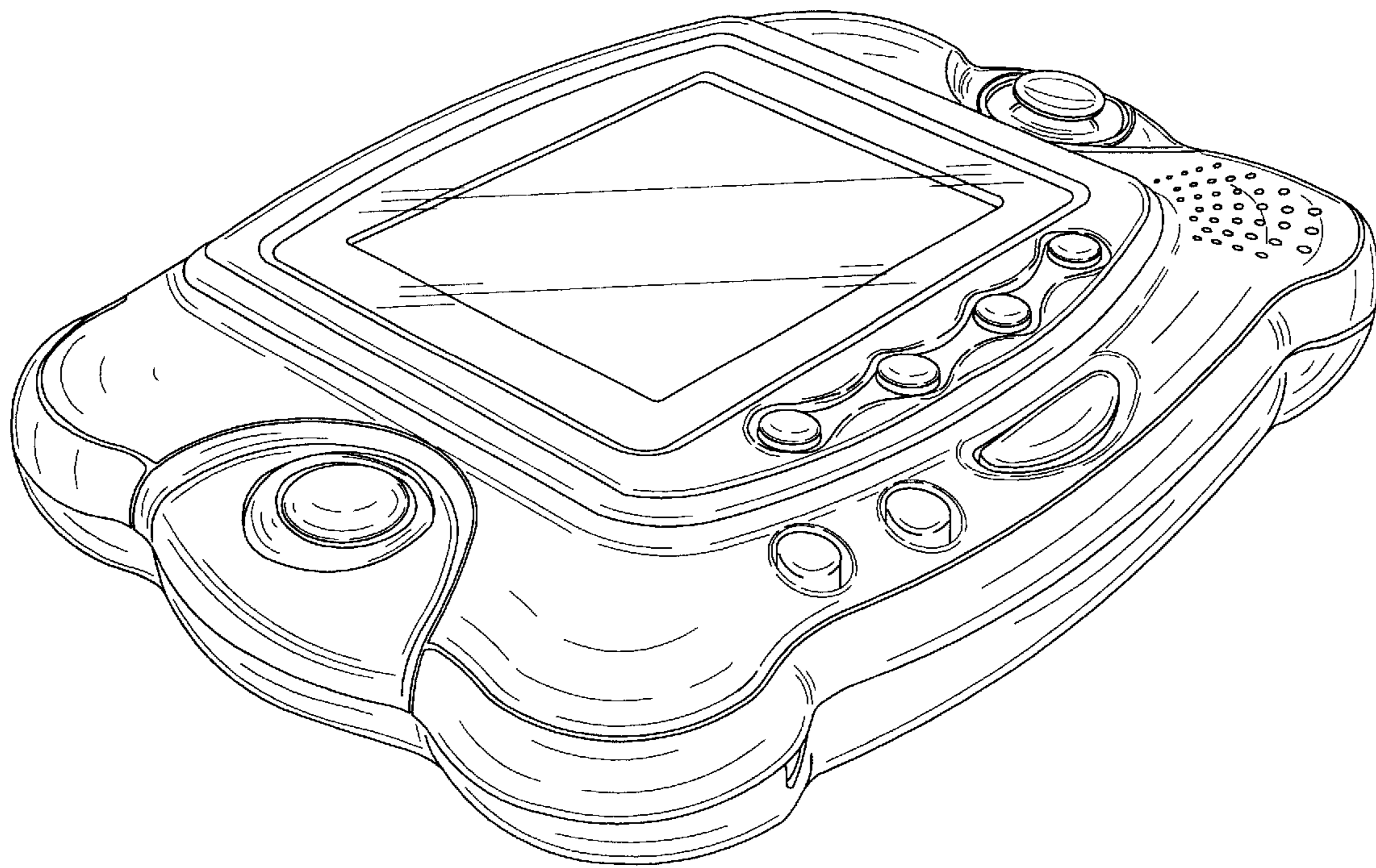

FIG. 7

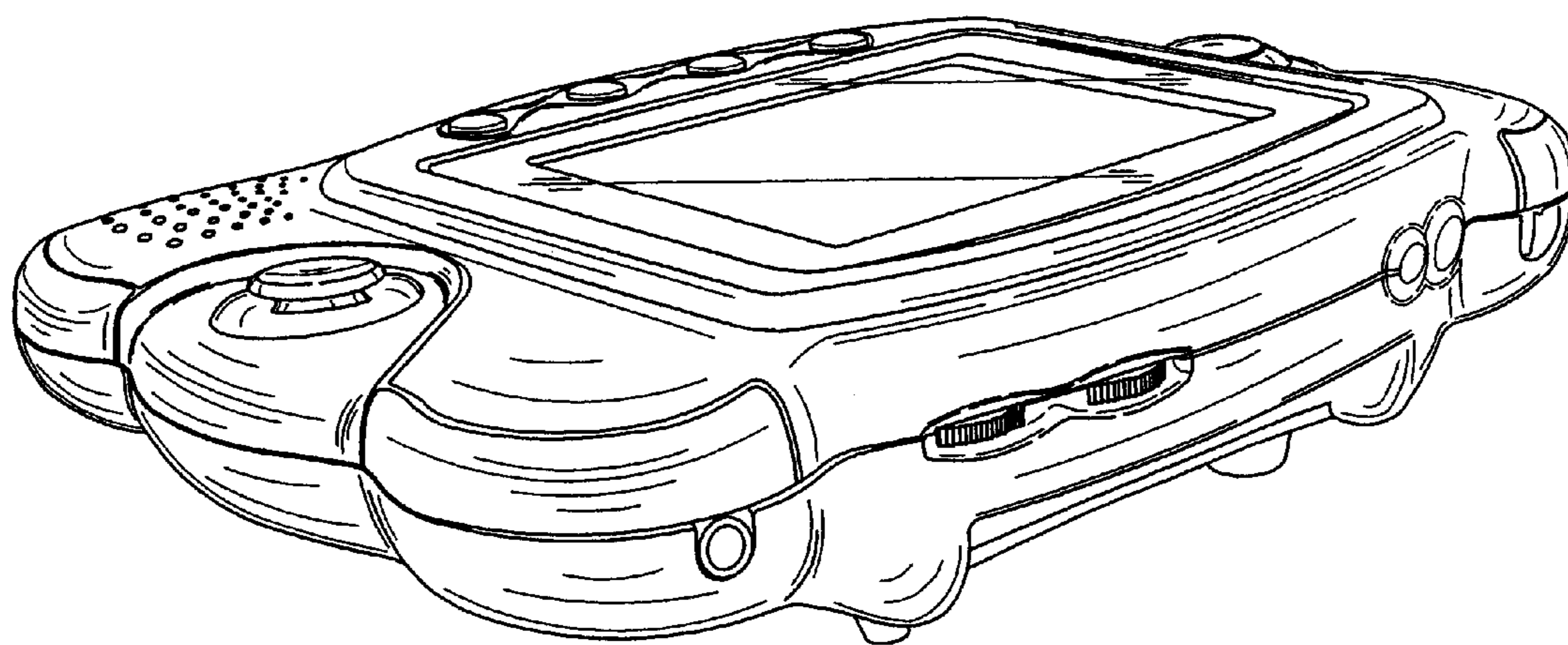

FIG. 8

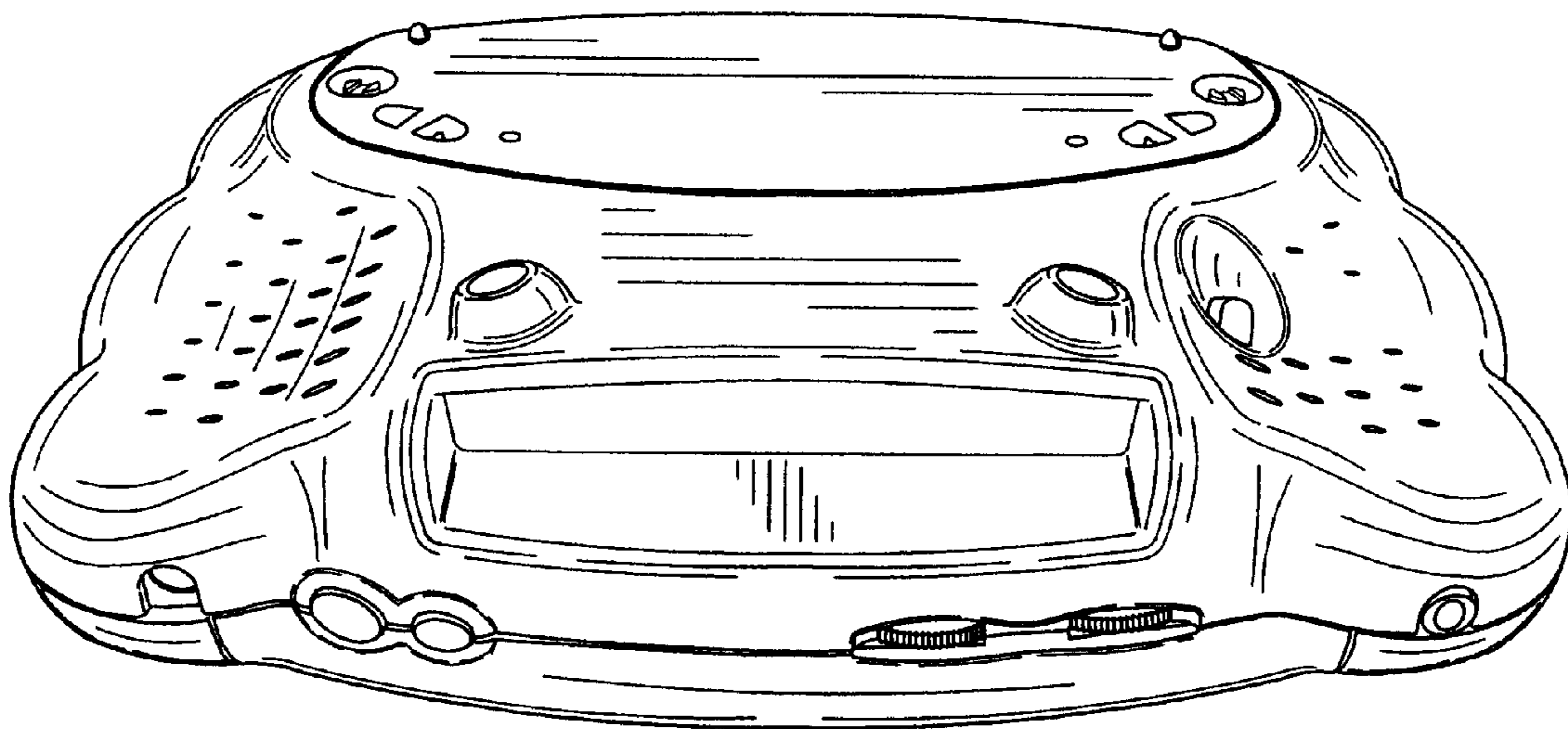

FIG. 9

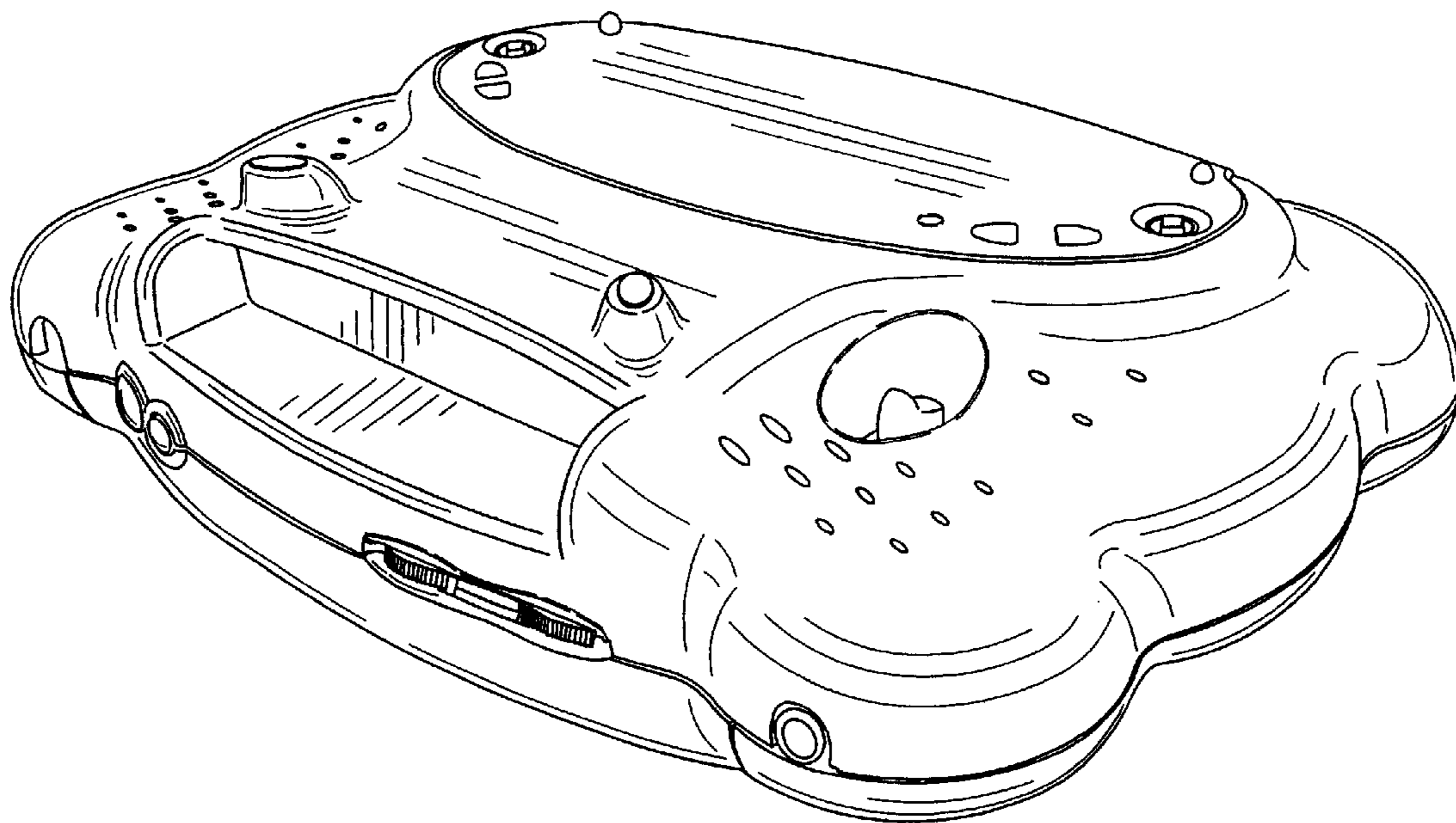

FIG. 10