



US00D539245S

(12) **United States Design Patent**
Bischoff

(10) **Patent No.:** **US D539,245 S**

(45) **Date of Patent:** **** Mar. 27, 2007**

(54) **TELEVISION RECEIVER**

(75) Inventor: **Corey Bischoff**, Roswell, GA (US)

(73) Assignee: **Koninklijke Philips Electronics N.V.**,
Eindhoven (NL)

(**) Term: **14 Years**

(21) Appl. No.: **29/224,692**

(22) Filed: **Mar. 4, 2005**

(30) **Foreign Application Priority Data**

Sep. 24, 2002 (EM) 000230339-0001

(51) **LOC (8) Cl.** **14-03**

(52) **U.S. Cl.** **D14/126**

(58) **Field of Classification Search** D14/125-134,
D14/239, 371, 136, 374-377; 312/7.2; 348/836,
348/838, 180, 184, 325, 739; 341/12; 248/917-924,
248/465; 345/104, 133, 156, 168, 87, 173;
720/605, 669, 600, 655; 369/99, 197; 455/344-347
See application file for complete search history.

(56) **References Cited**

U.S. PATENT DOCUMENTS

D350,743 S * 9/1994 Hicks et al. D14/130

D407,074 S * 3/1999 Lee D14/375
D461,184 S * 8/2002 Chen D14/336
D462,074 S * 8/2002 Kim D14/375
D481,390 S * 10/2003 Wang et al. D14/374
D515,048 S * 2/2006 Villalobos et al. D14/128
D527,353 S * 8/2006 Imboden et al. D14/126

OTHER PUBLICATIONS

White Oak Pharmacy, p. 62, 2003.*

* cited by examiner

Primary Examiner—Raphael Barkai

(57) **CLAIM**

The ornamental design for a television receiver, as shown.

DESCRIPTION

FIG. 1 is a perspective view showing my design;
FIG. 2 is a front elevational view thereof;
FIG. 3 is a rear elevational view thereof;
FIG. 4 is a right side elevational view thereof;
FIG. 5 is a left side elevational view thereof;
FIG. 6 is a top plan view thereof; and,
FIG. 7 is a bottom plan view thereof.

1 Claim, 5 Drawing Sheets

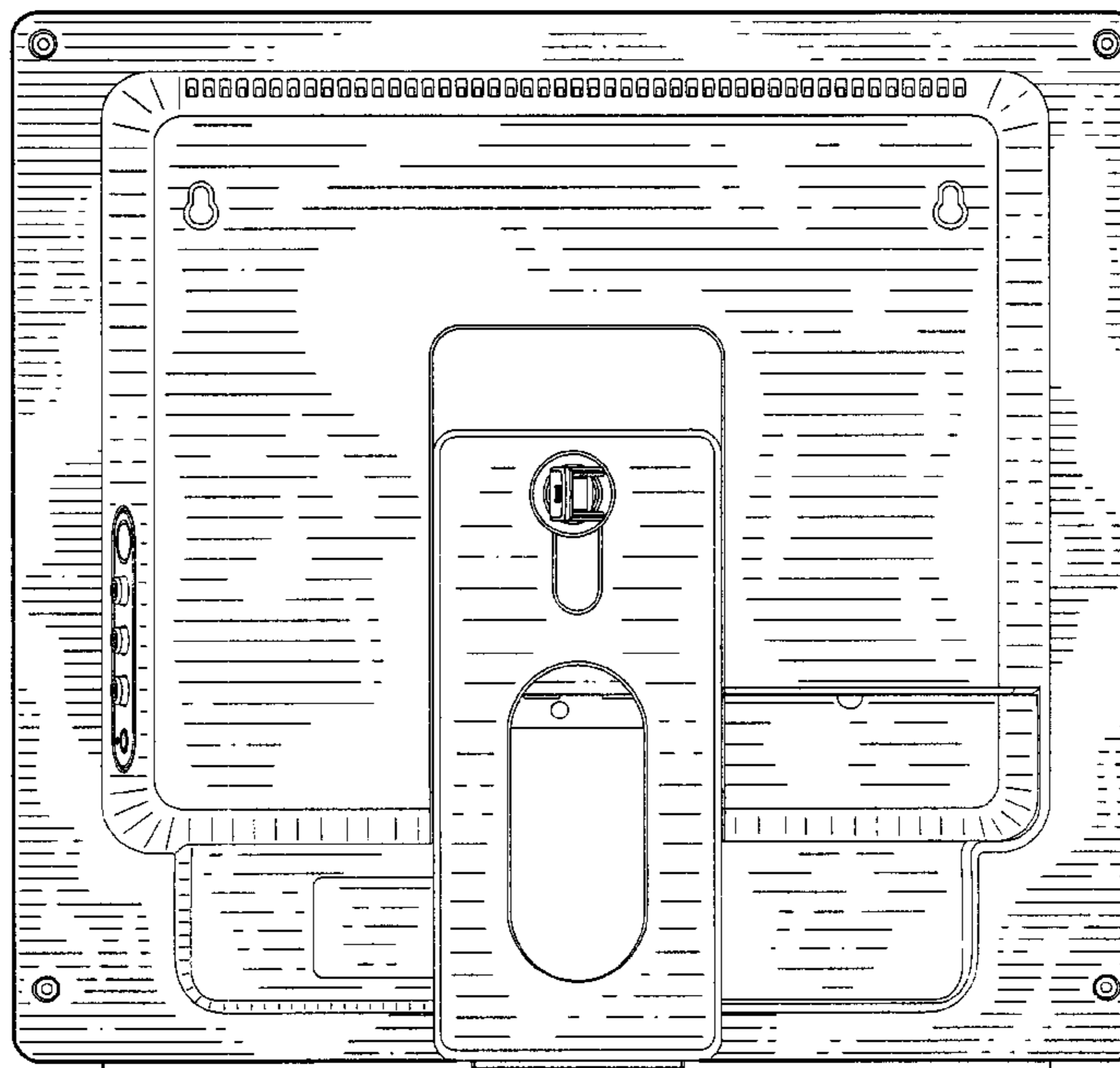
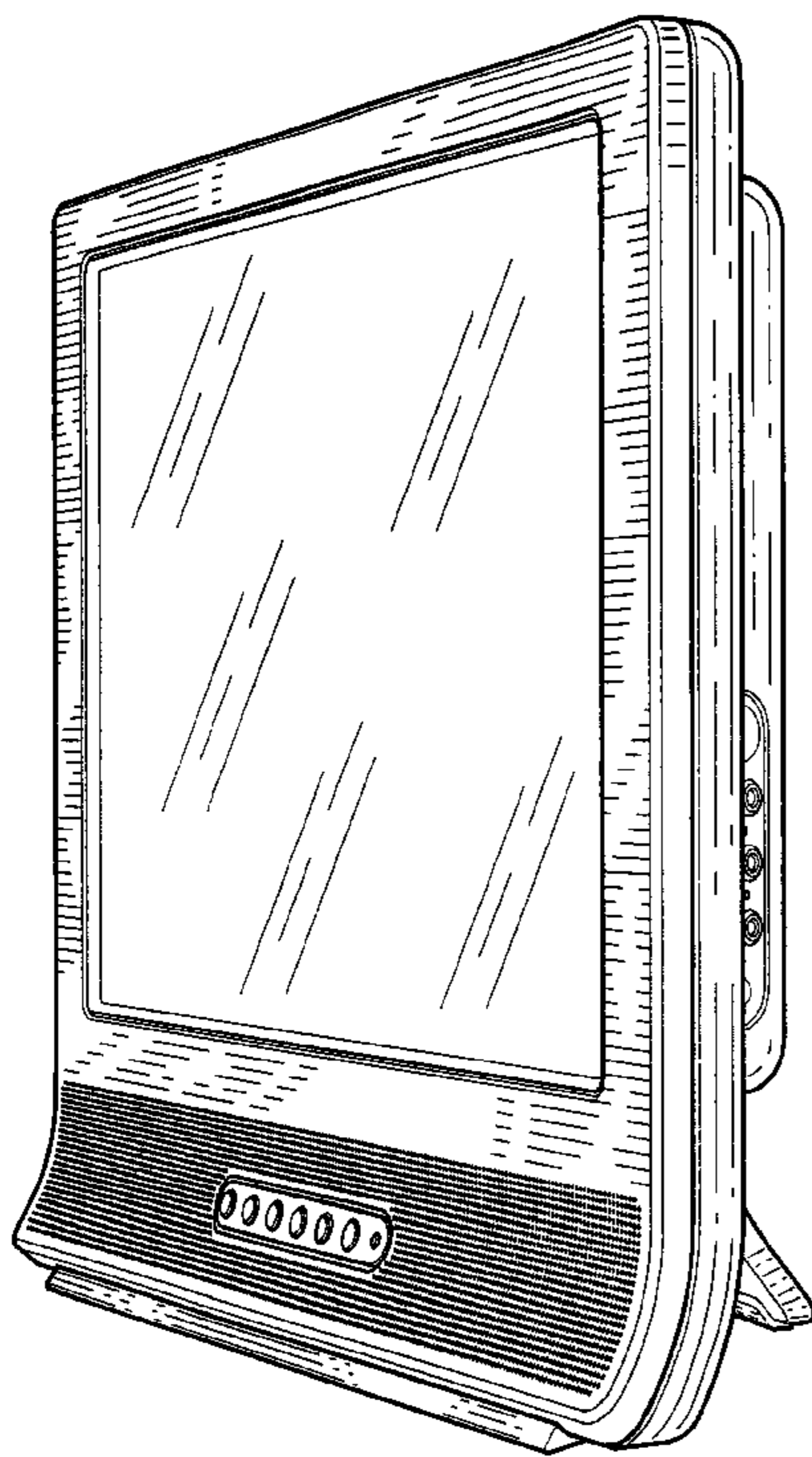

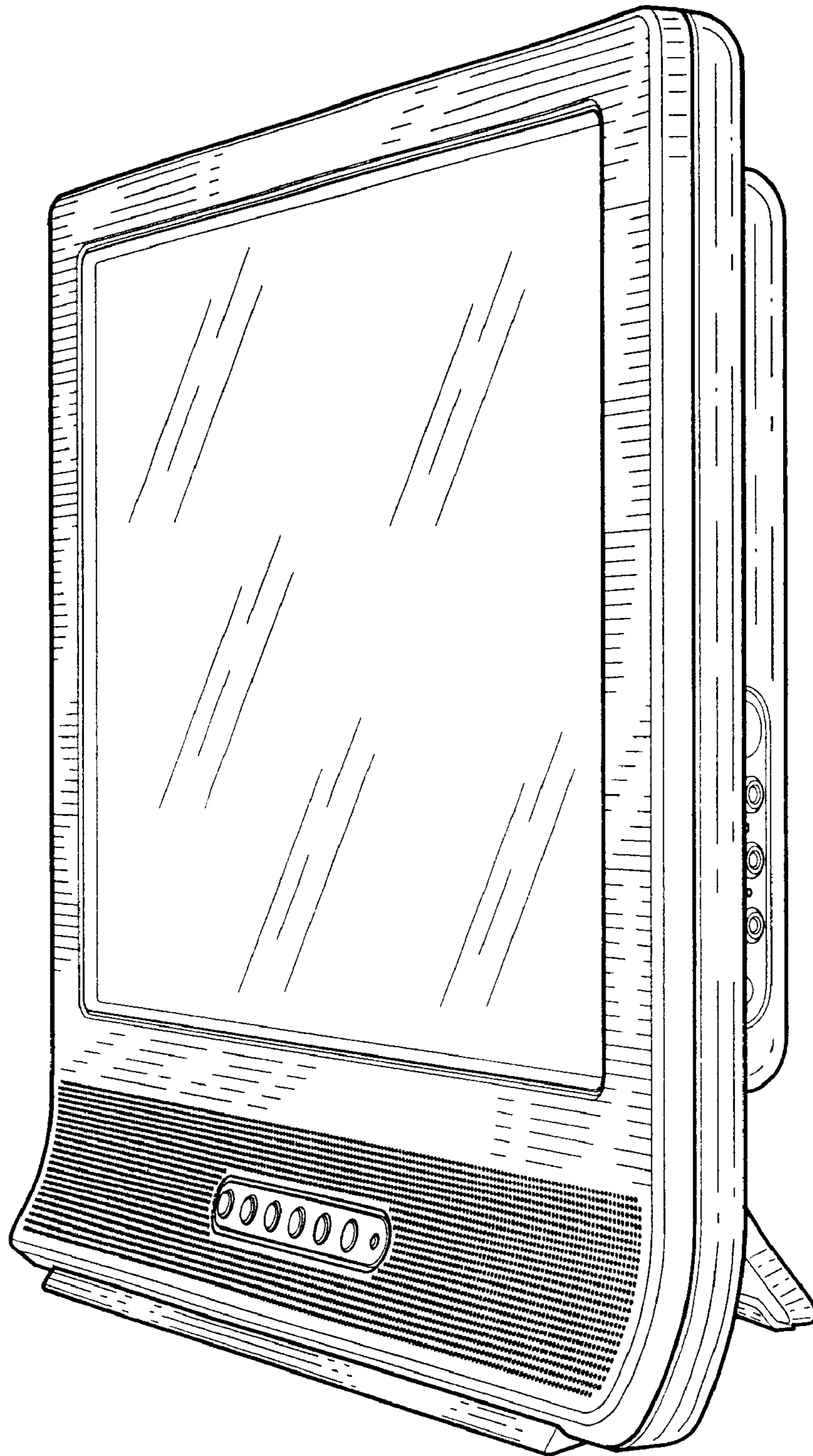

FIG. 1

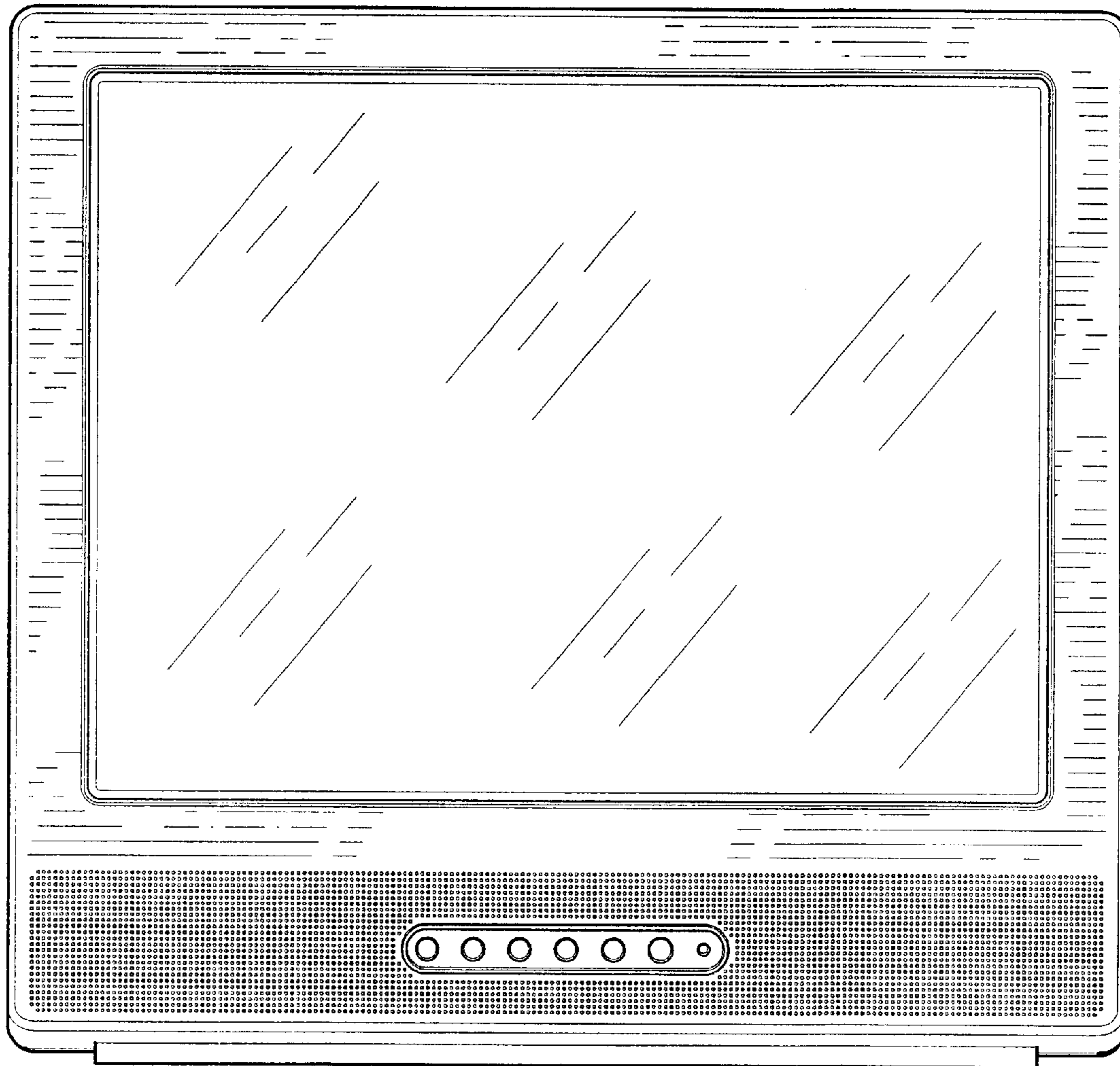

FIG. 2

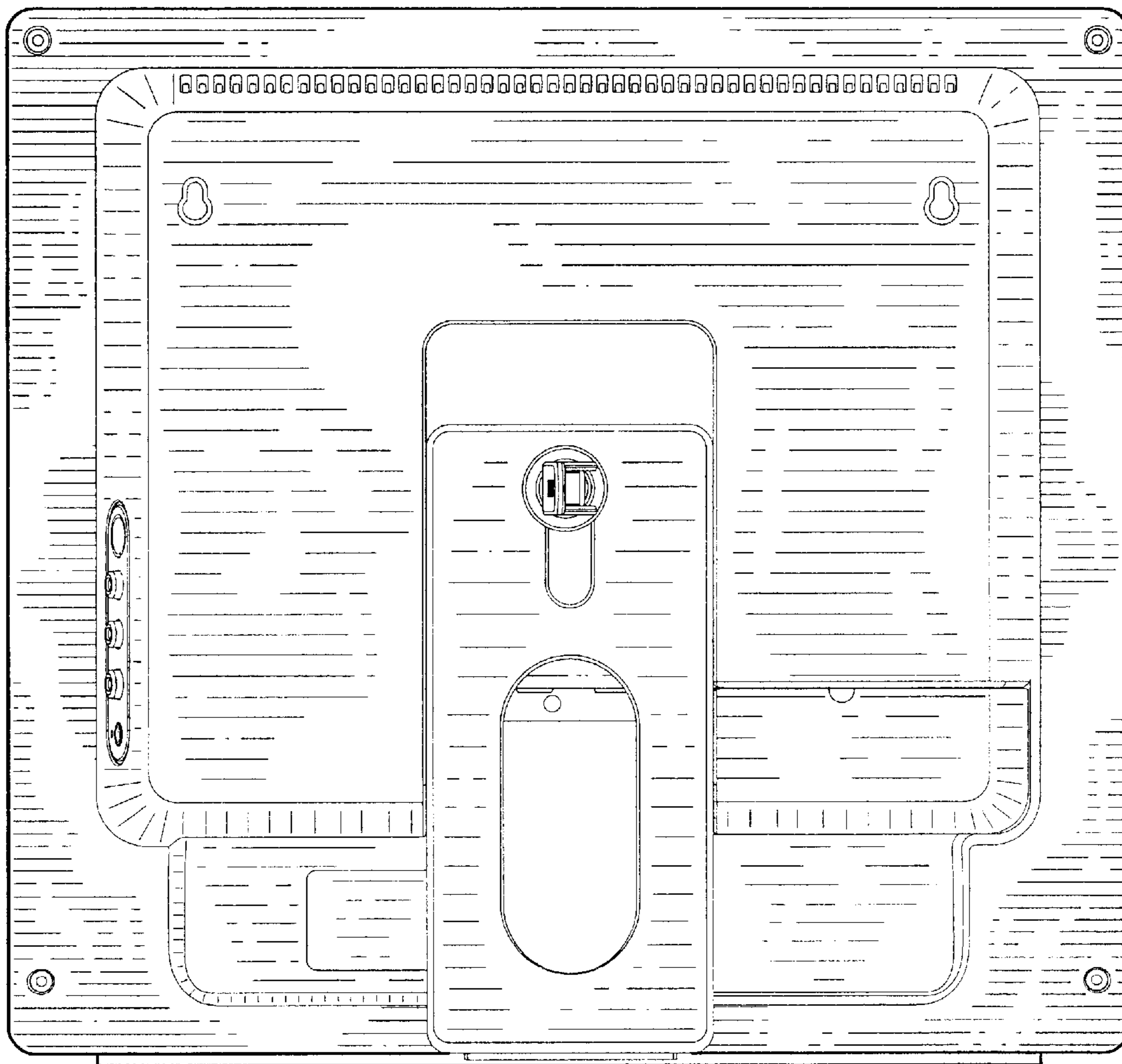

FIG. 3

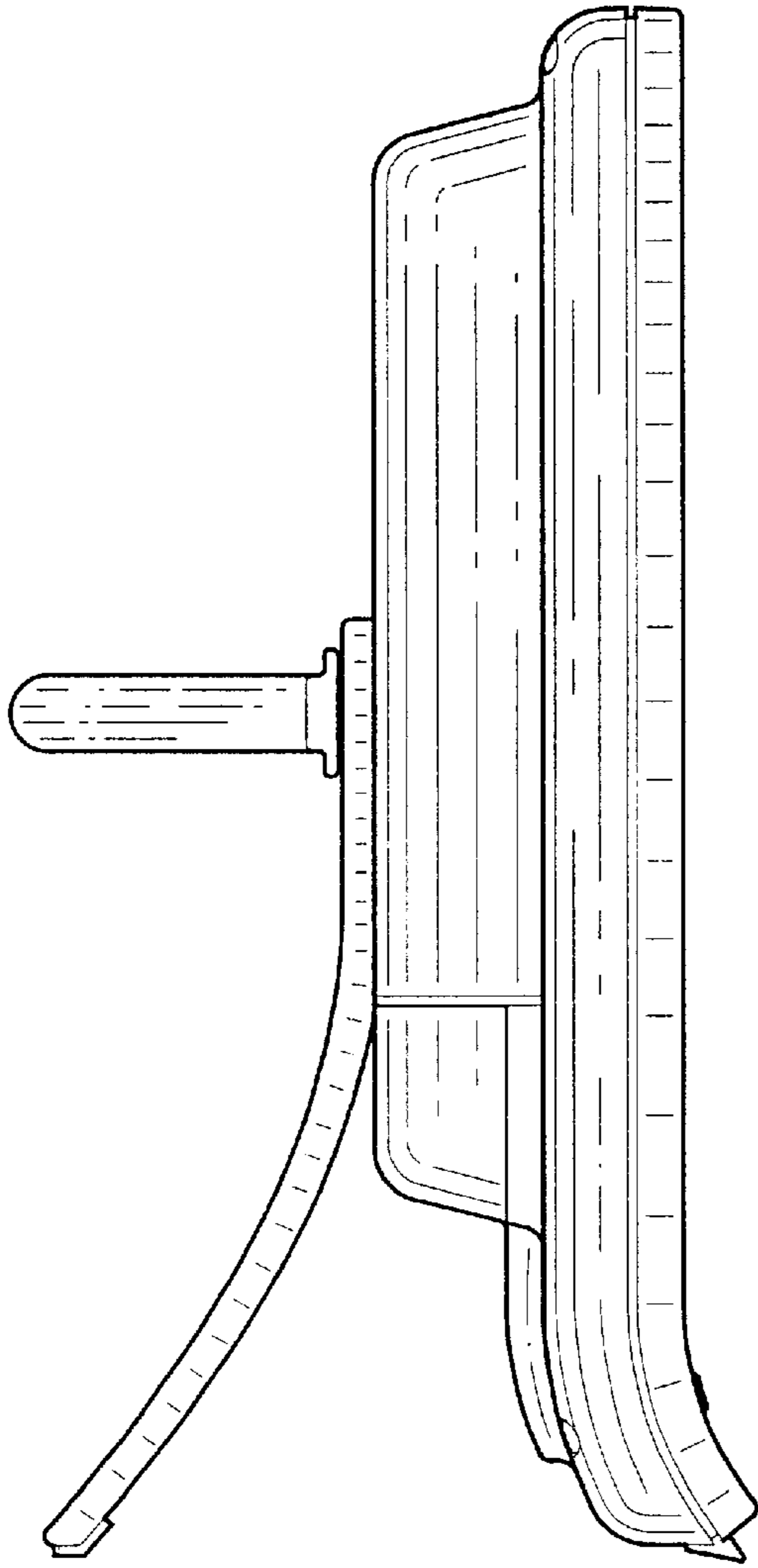

FIG. 4

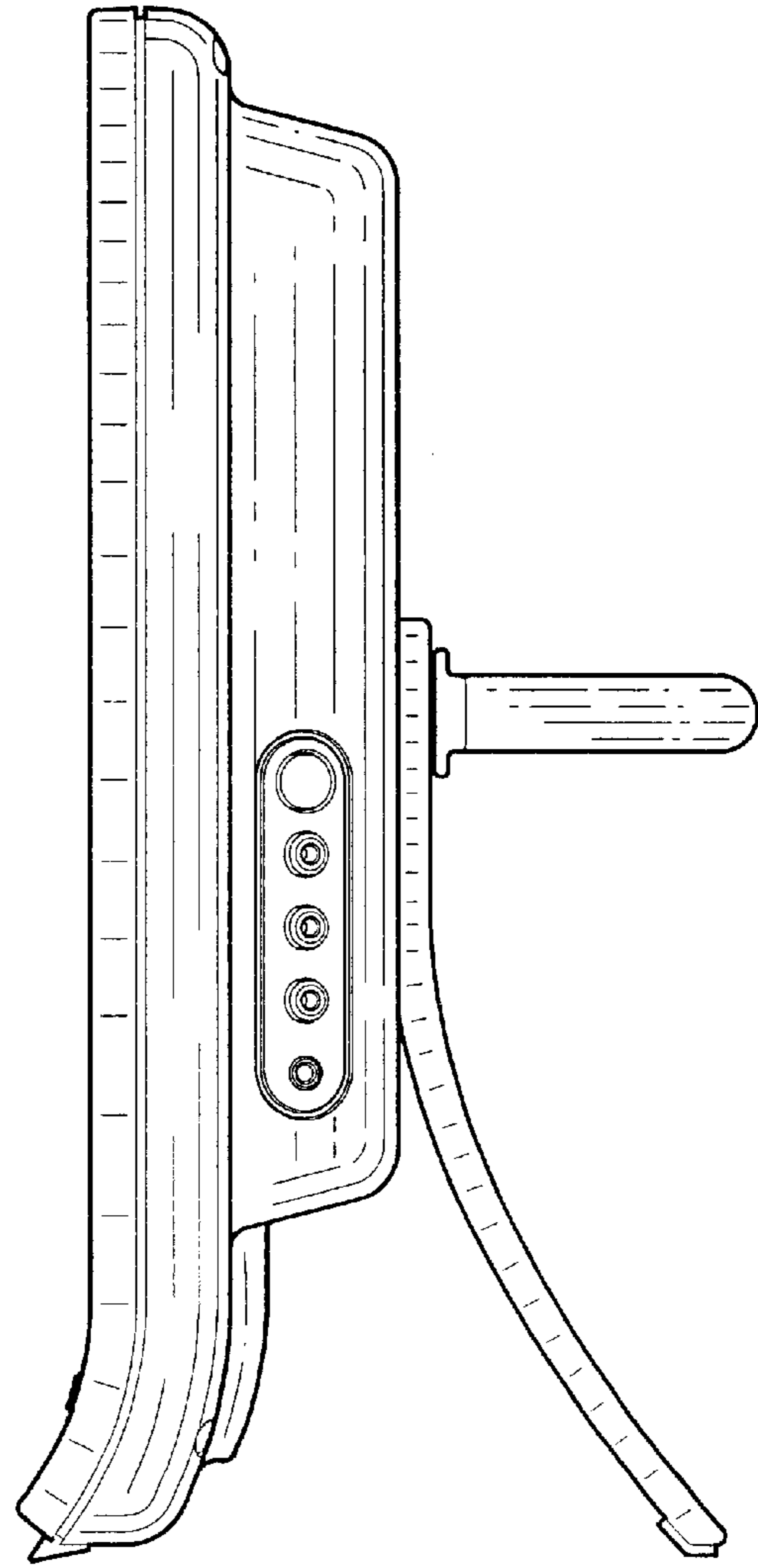

FIG. 5

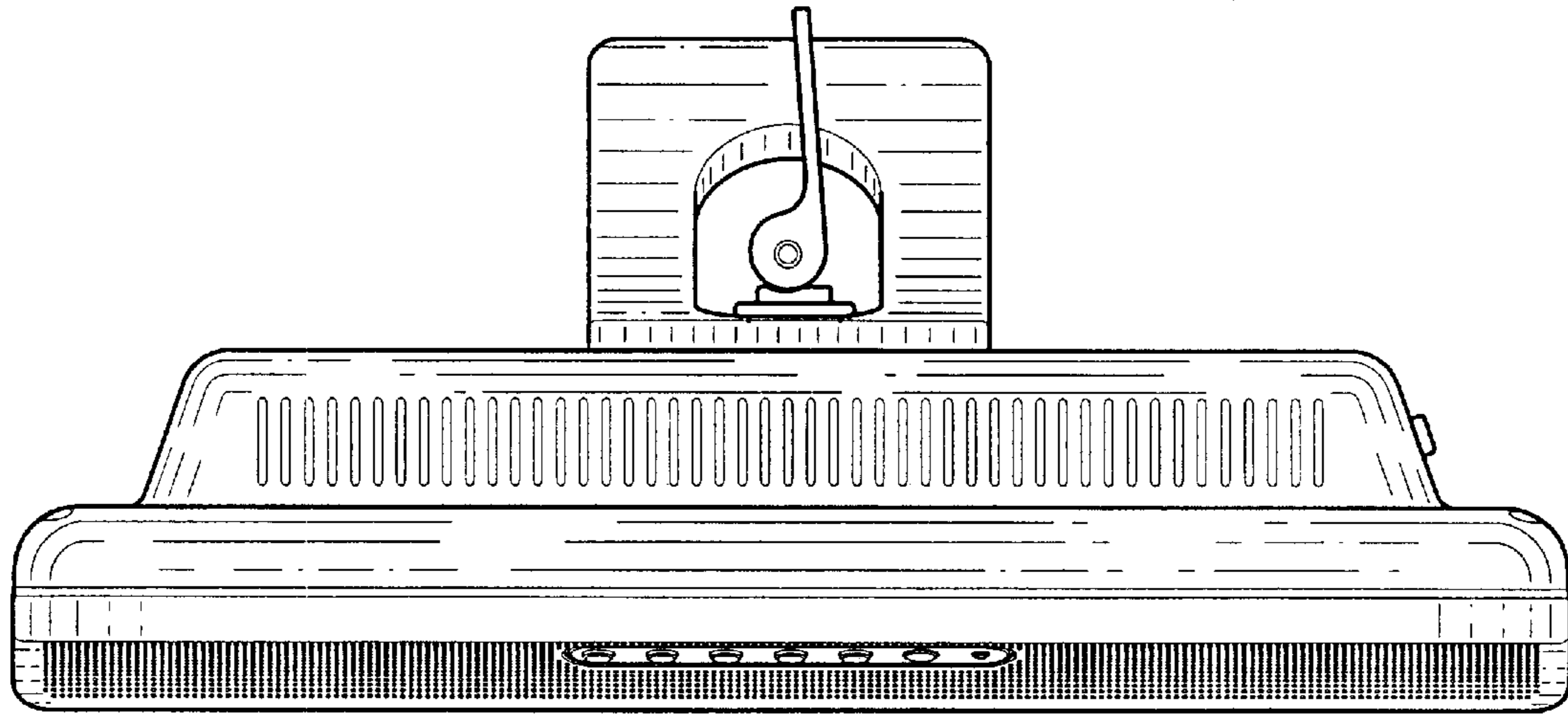

FIG. 6

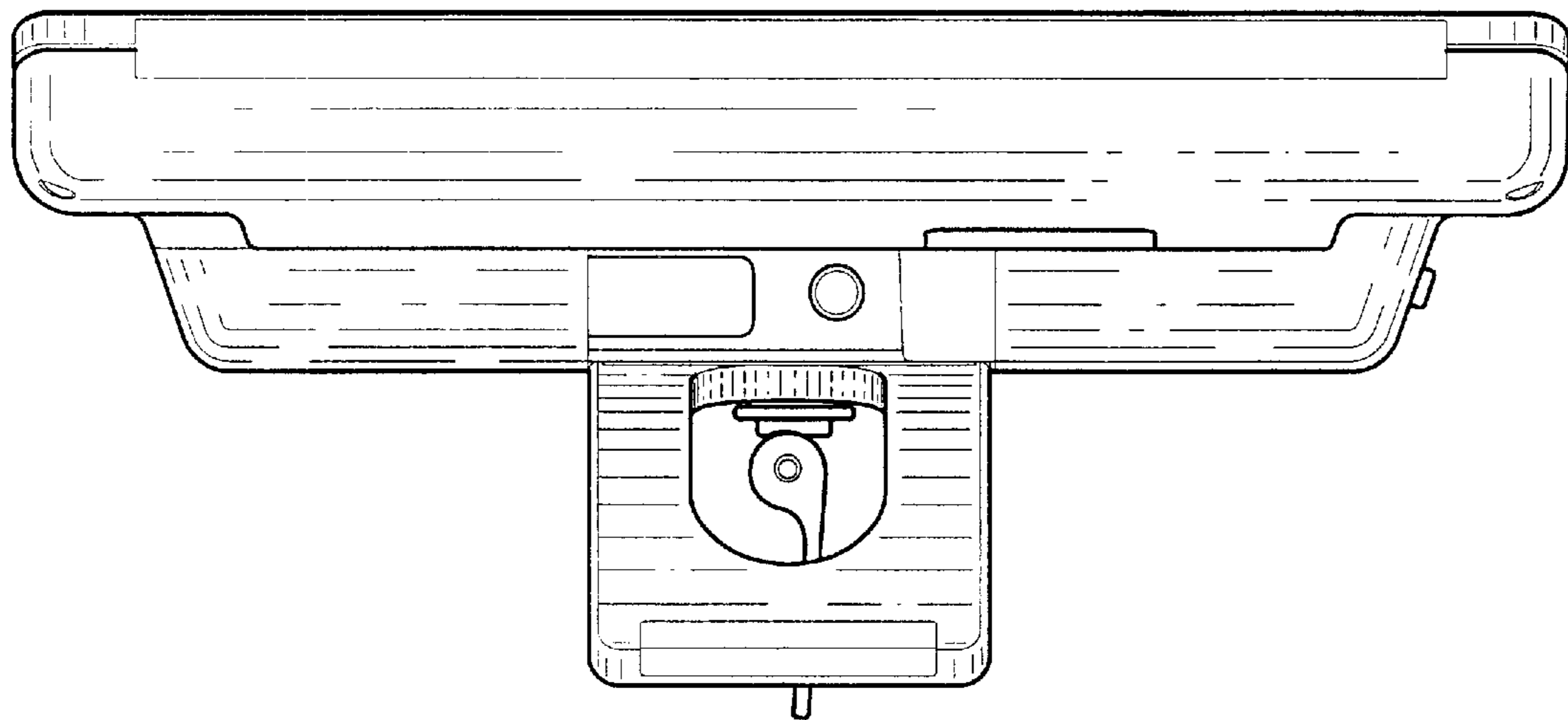

FIG. 7