



US00D539192S

(12) **United States Design Patent**
Chen et al.

(10) **Patent No.:** **US D539,192 S**

(45) **Date of Patent:** **** Mar. 27, 2007**

(54) **SCOOTER**

(75) Inventors: **Chia-Ching Chen**, Kaohsiung (TW);
Jung-Chung Chen, Kaohsiung (TW)

(73) Assignee: **Kwang Yang Motor Co., Ltd.**,
Kaohsiung (TW)

(**) Term: **14 Years**

(21) Appl. No.: **29/246,695**

(22) Filed: **May 4, 2006**

(51) **LOC (8) Cl.** **12-11**

(52) **U.S. Cl.** **D12/110**

(58) **Field of Classification Search** D12/110;
180/219, 220, 225, 229
See application file for complete search history.

(56) **References Cited**

U.S. PATENT DOCUMENTS

D475,950 S * 6/2003 Kawano et al. D12/110
D493,122 S * 7/2004 Huang et al. D12/110

D521,415 S * 5/2006 Kojima et al. D12/110
D521,908 S * 5/2006 Hong D12/110
D522,927 S * 6/2006 Lin D12/110

* cited by examiner

Primary Examiner—Alan P. Douglas

Assistant Examiner—Linda Brooks

(74) *Attorney, Agent, or Firm*—Leong C. Lei

(57) **CLAIM**

The ornamental design for a scooter, as shown and described.

DESCRIPTION

FIG. 1 is perspective view of a scooter showing my new design;

FIG. 2 is a front side elevation view thereof;

FIG. 3 is a rear side elevation view thereof;

FIG. 4 is a left side elevation view thereof;

FIG. 5 is a right side elevation view thereof;

FIG. 6 is a top plan view thereof; and,

FIG. 7 is a bottom plan view thereof.

1 Claim, 6 Drawing Sheets



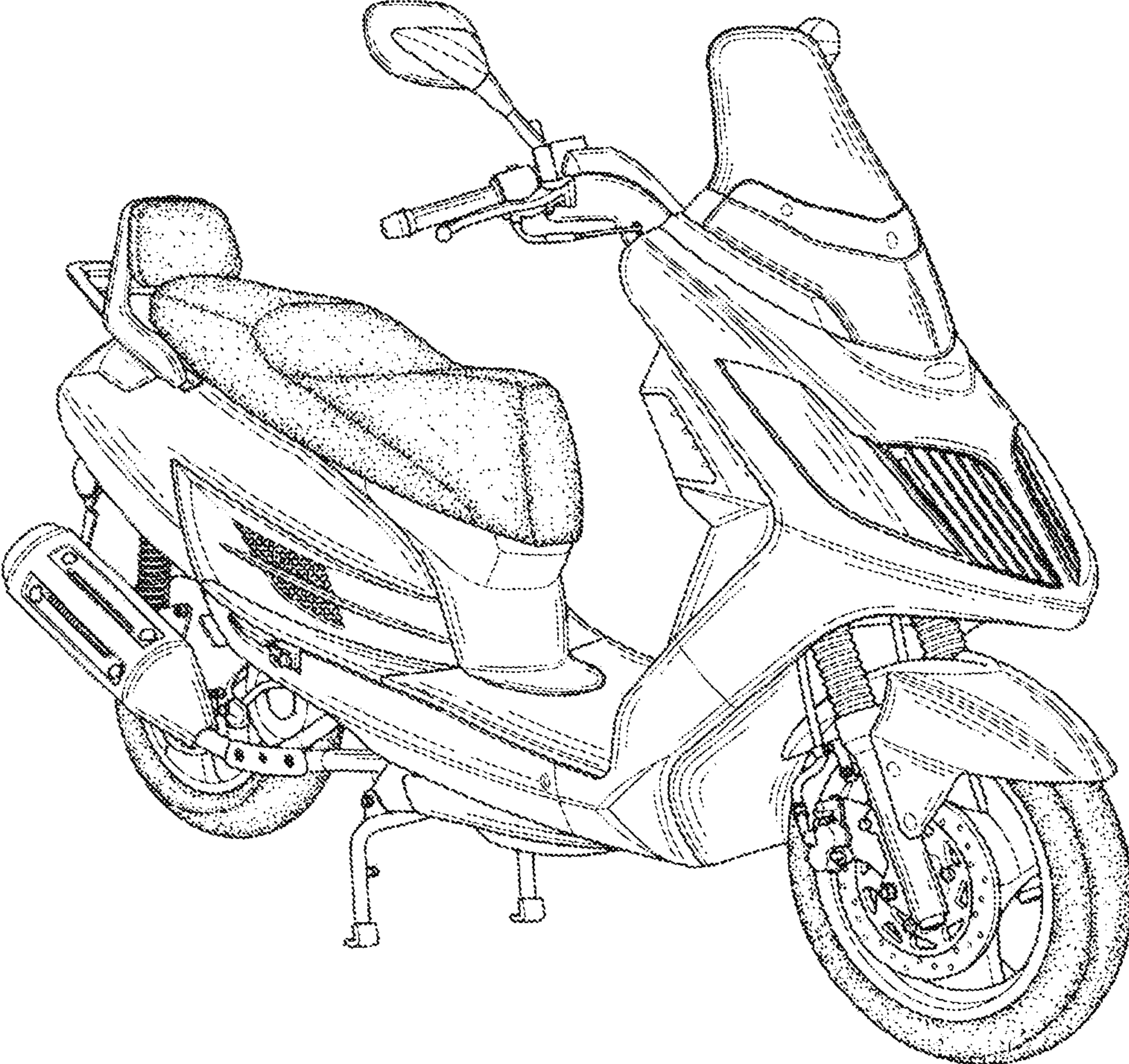

FIG. 1

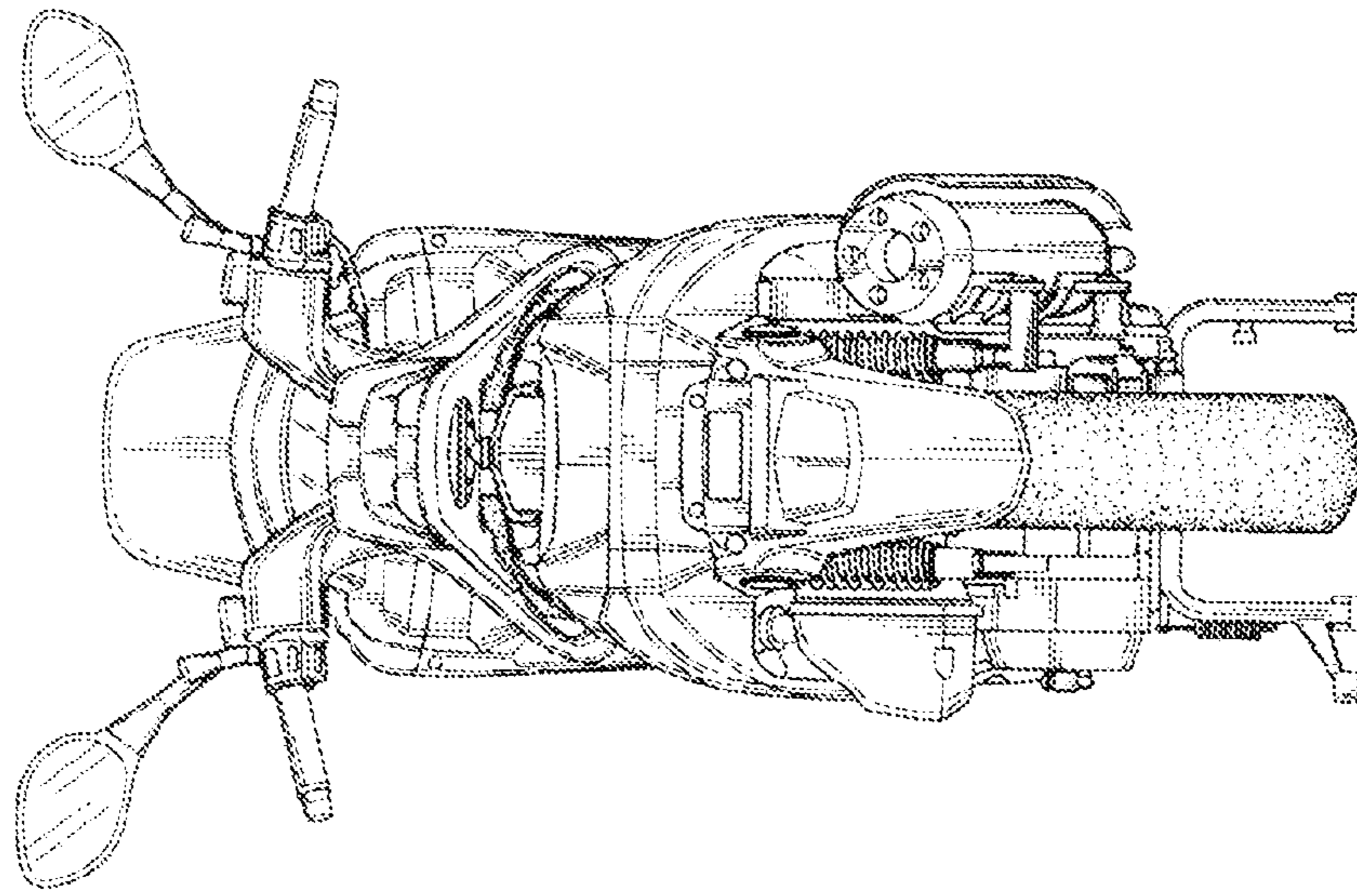

FIG.3

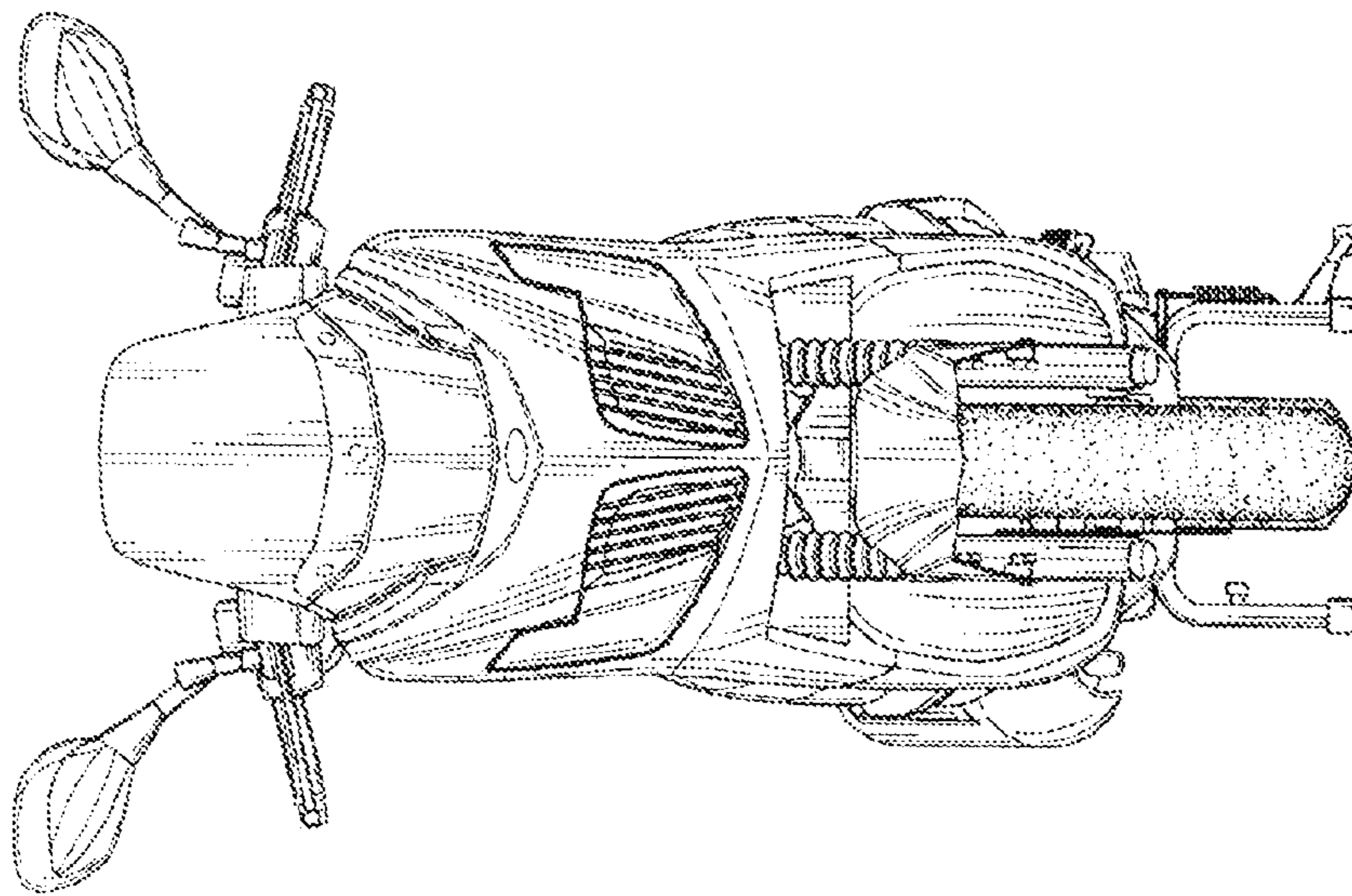

FIG.2

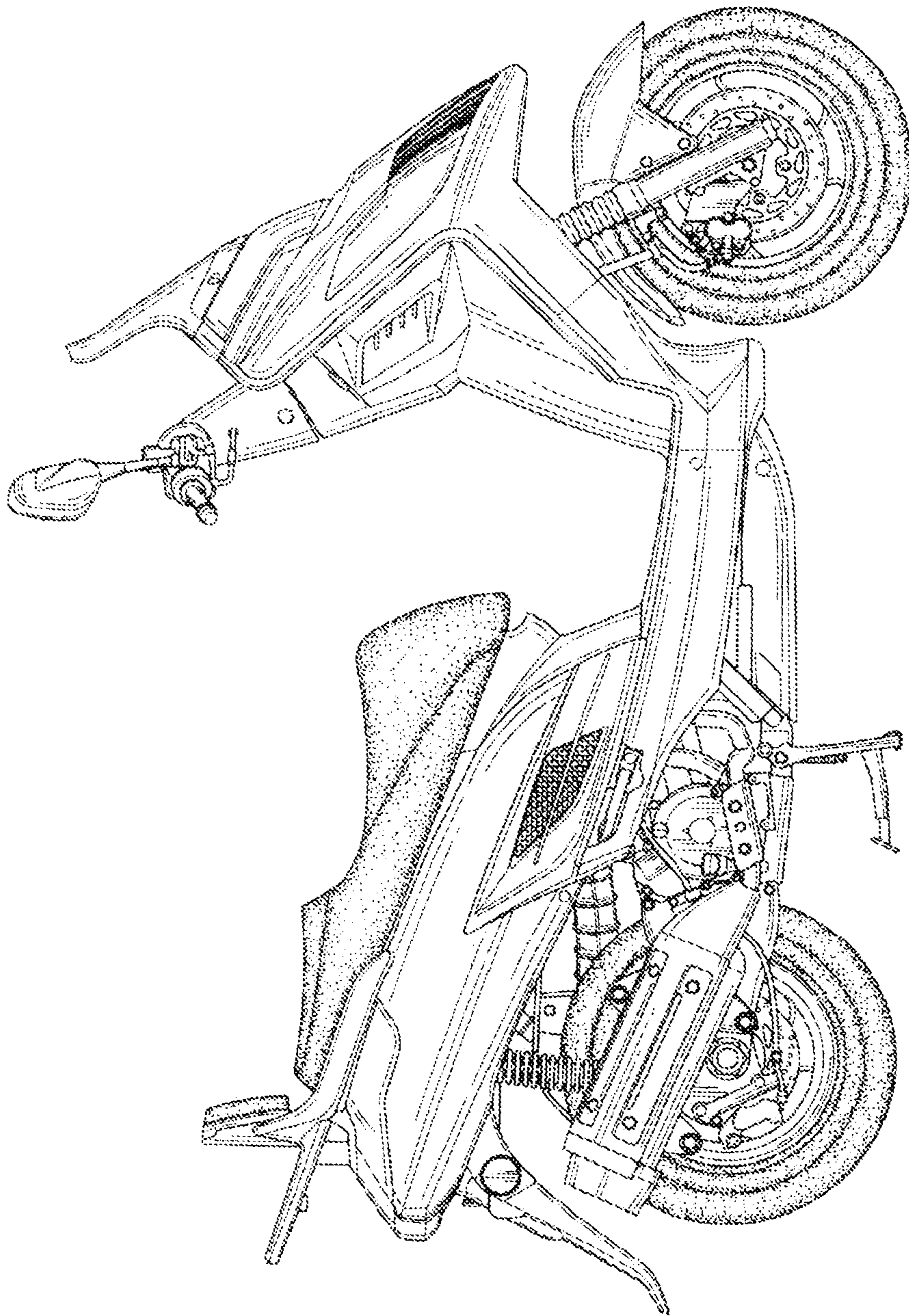

FIG.4

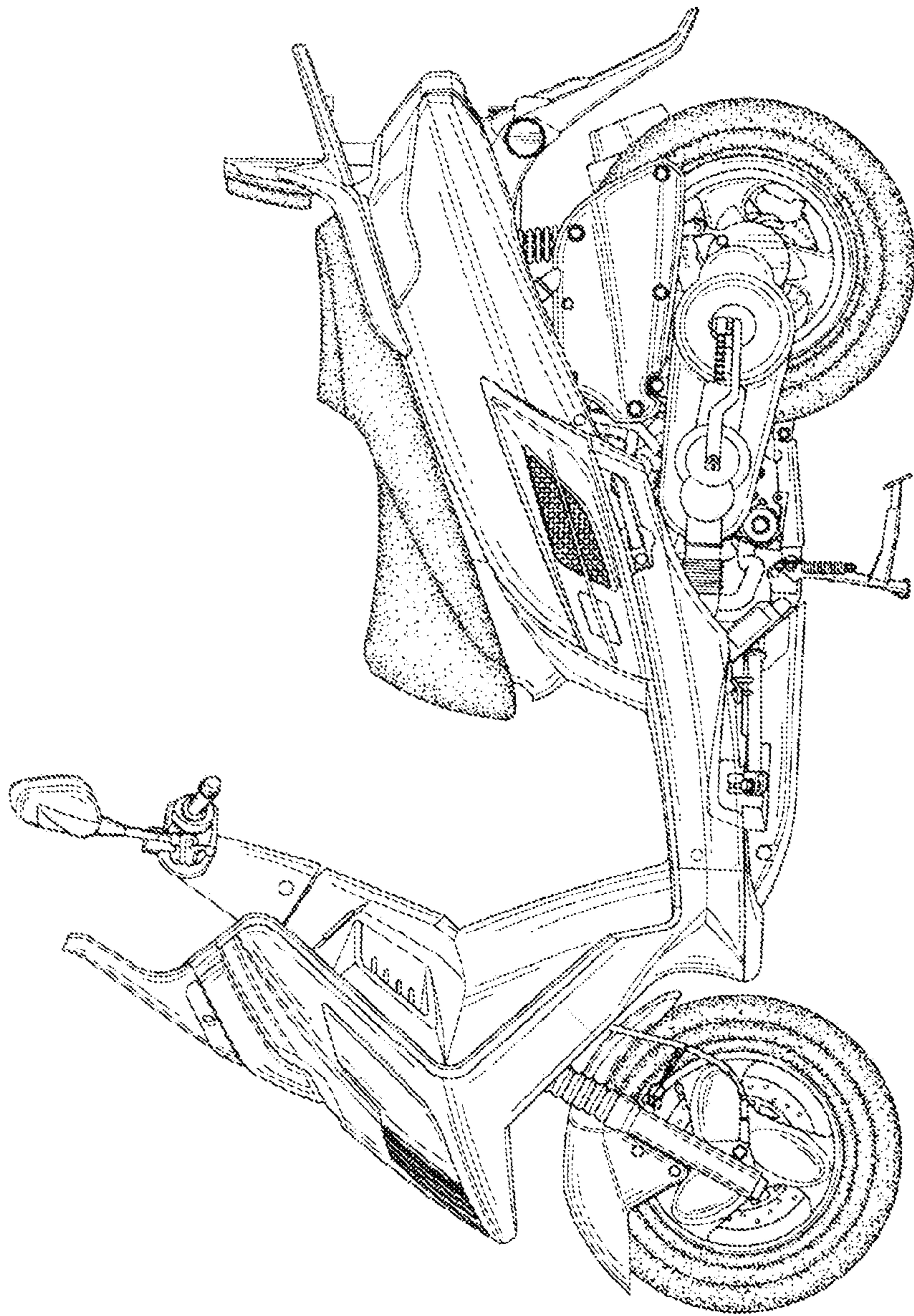

FIG.5

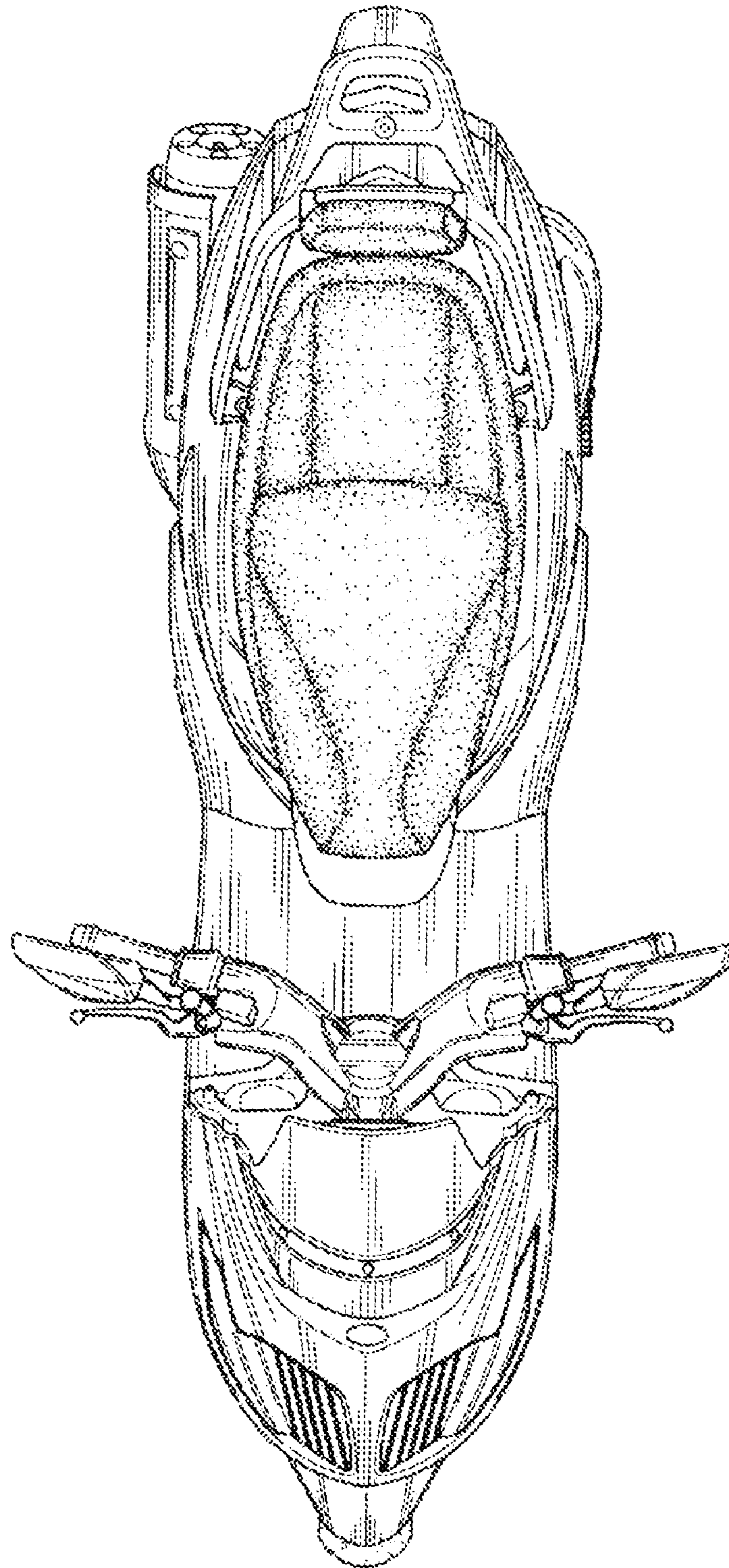

FIG. 6

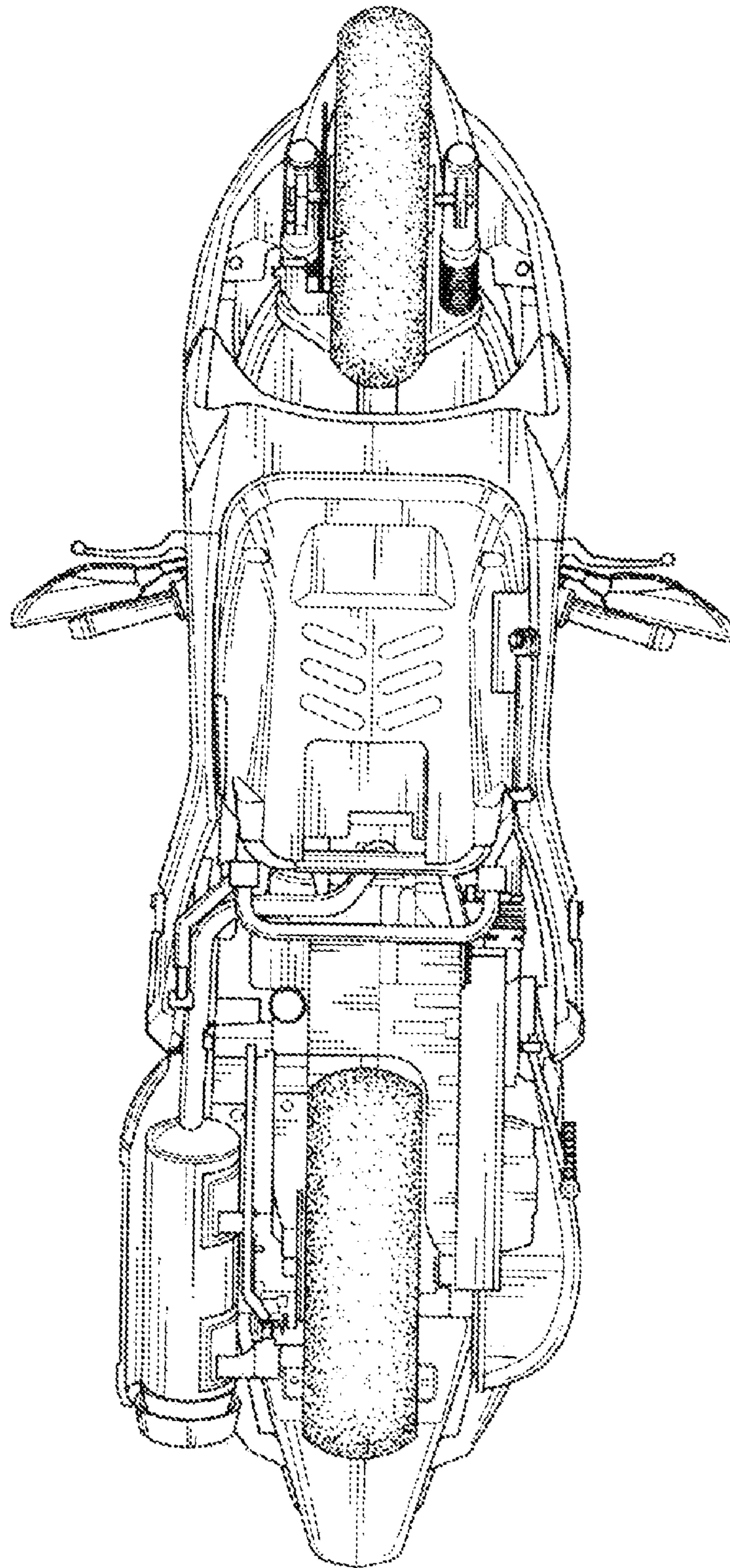

FIG. 7