



US00D539138S

(12) **United States Design Patent**  
**Mittelstaedt et al.**

(10) **Patent No.:** **US D539,138 S**

(45) **Date of Patent:** **\*\* Mar. 27, 2007**

(54) **STORAGE CONTAINER**

(75) Inventors: **Chris Mittelstaedt**, 405 Victory Dr., Suite D, South San Francisco, CA (US) 94080; **Richard G. Hansen**, San Francisco, CA (US); **Kevin McKim**, Modesto, CA (US); **Erich Boese**, Modesto, CA (US); **Tony Joyce**, Modesto, CA (US)

(73) Assignee: **Chris Mittelstaedt**, San Francisco, CA (US)

(\*\*) Term: **14 Years**

(21) Appl. No.: **29/245,051**

(22) Filed: **Dec. 15, 2005**

(51) **LOC (8) Cl.** ..... **09-03**

(52) **U.S. Cl.** ..... **D9/432**

(58) **Field of Classification Search** ..... D9/414, D9/418, 420-423, 430-433; 229/122, 157, 229/120, 156, 113, 171, 174, 178, DIG. 11, 229/163

See application file for complete search history.

(56) **References Cited**

**U.S. PATENT DOCUMENTS**

2,104,828 A \* 1/1938 Brinnon ..... 206/278  
3,485,433 A \* 12/1969 Rapp ..... 229/122.25  
D248,621 S \* 7/1978 Hay et al. .... D9/431

D270,041 S \* 8/1983 Vestal ..... D9/416  
D384,502 S \* 10/1997 Seager et al. .... D3/294  
D408,631 S \* 4/1999 Dickinson et al. .... D3/302  
D479,685 S \* 9/2003 Zanchetta et al. .... D9/433  
D495,248 S \* 8/2004 Krebs et al. .... D9/418  
D504,771 S \* 5/2005 Boyd et al. .... D3/273  
D505,620 S \* 5/2005 Huebsch ..... D9/416

\* cited by examiner

*Primary Examiner*—Stella Reid

*Assistant Examiner*—Mark Goodwin

(74) *Attorney, Agent, or Firm*—Weisner & Associates; Leland Wiesner

(57) **CLAIM**

What is claimed is an ornamental design for a storage container, as shown.

**DESCRIPTION**

This application is copending with U.S. application Ser. No. 11/305,487, filed Dec. 15, 2005, and titled "Storage Container Device."

FIG. 1 is a perspective view of a storage container showing the new design;

FIG. 2 is an edge thereof;

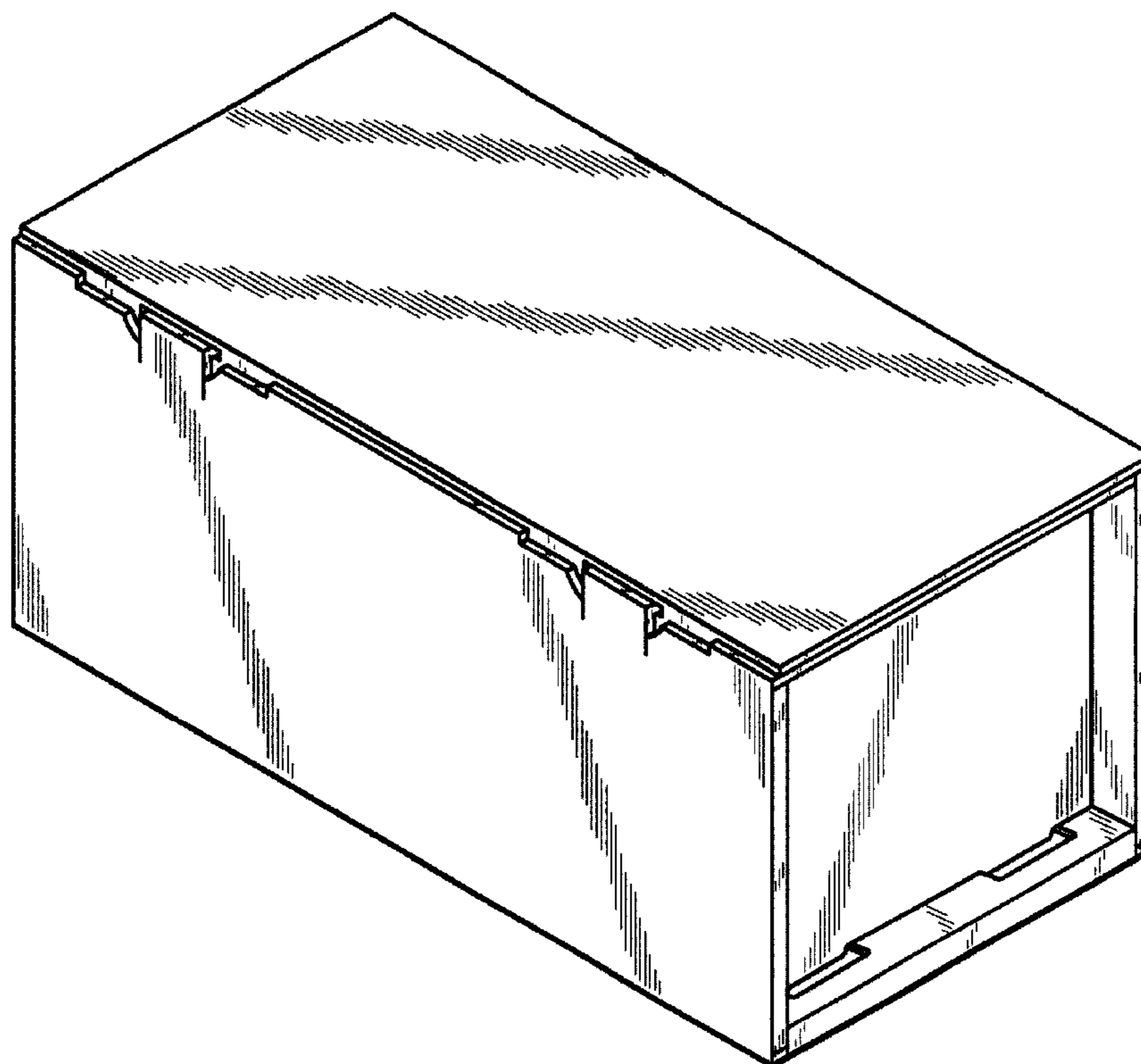
FIG. 3 is a first side view thereof;

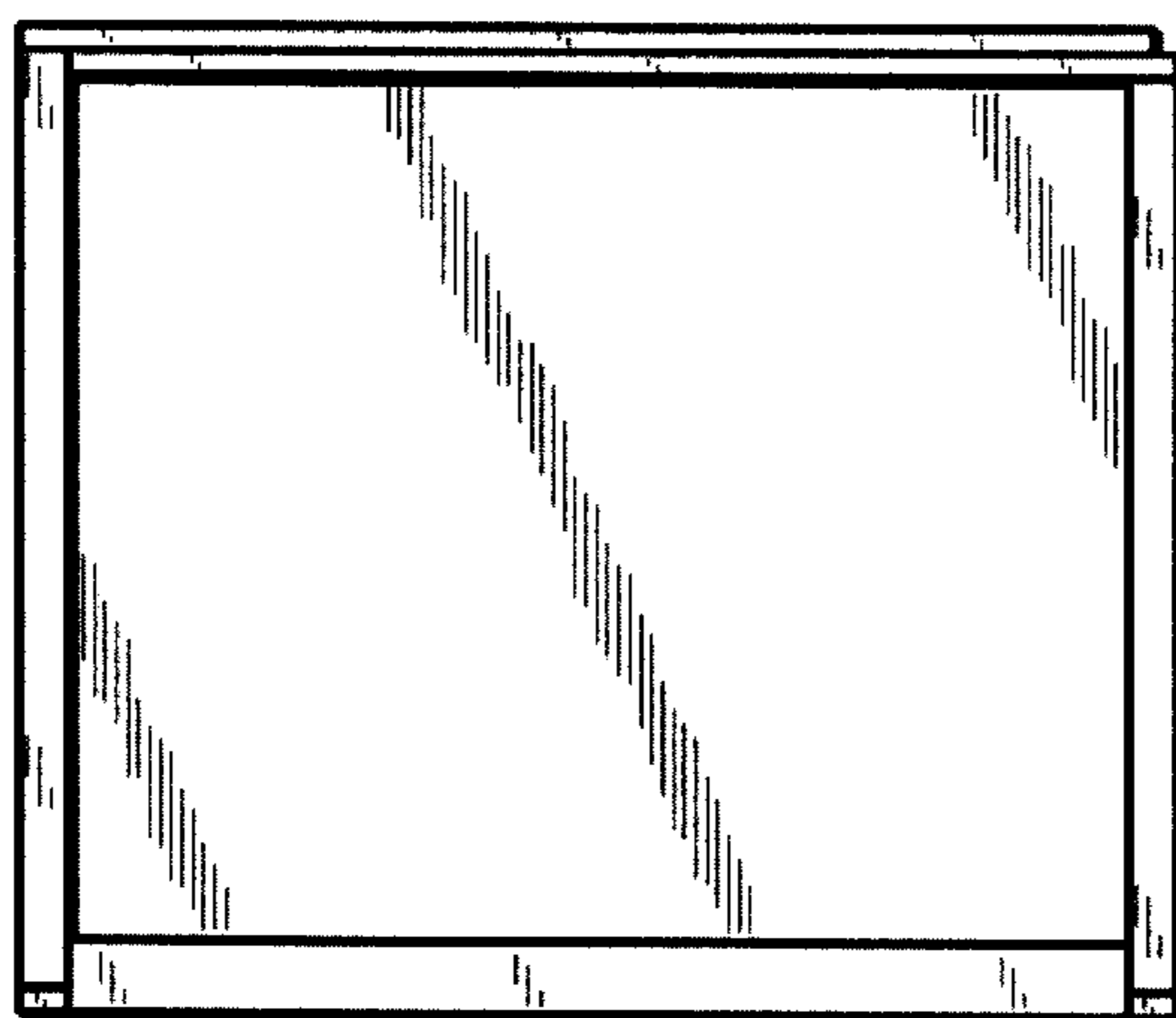
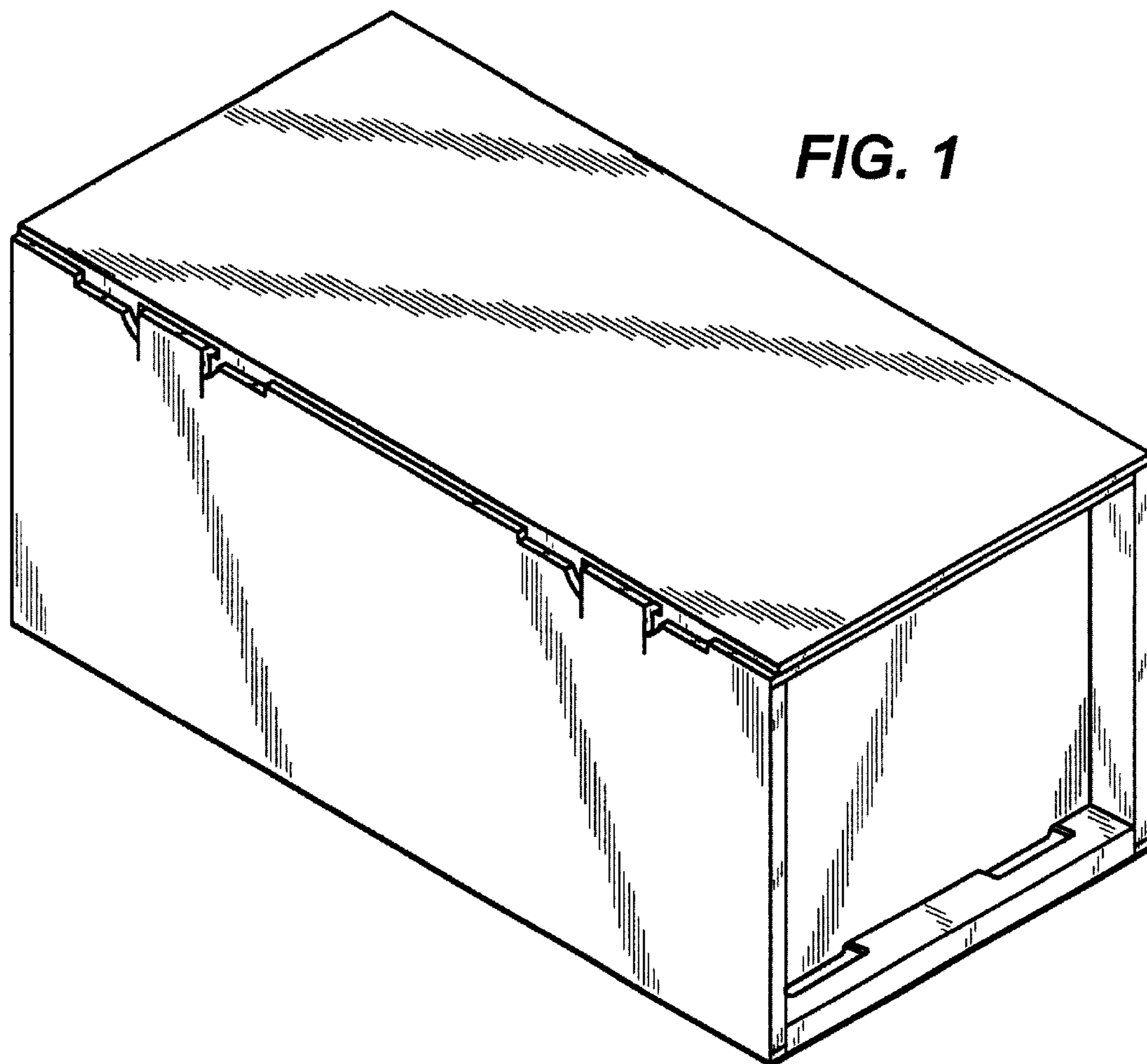
FIG. 4 is a bottom view thereof;

FIG. 5 is a second side view thereof; and,

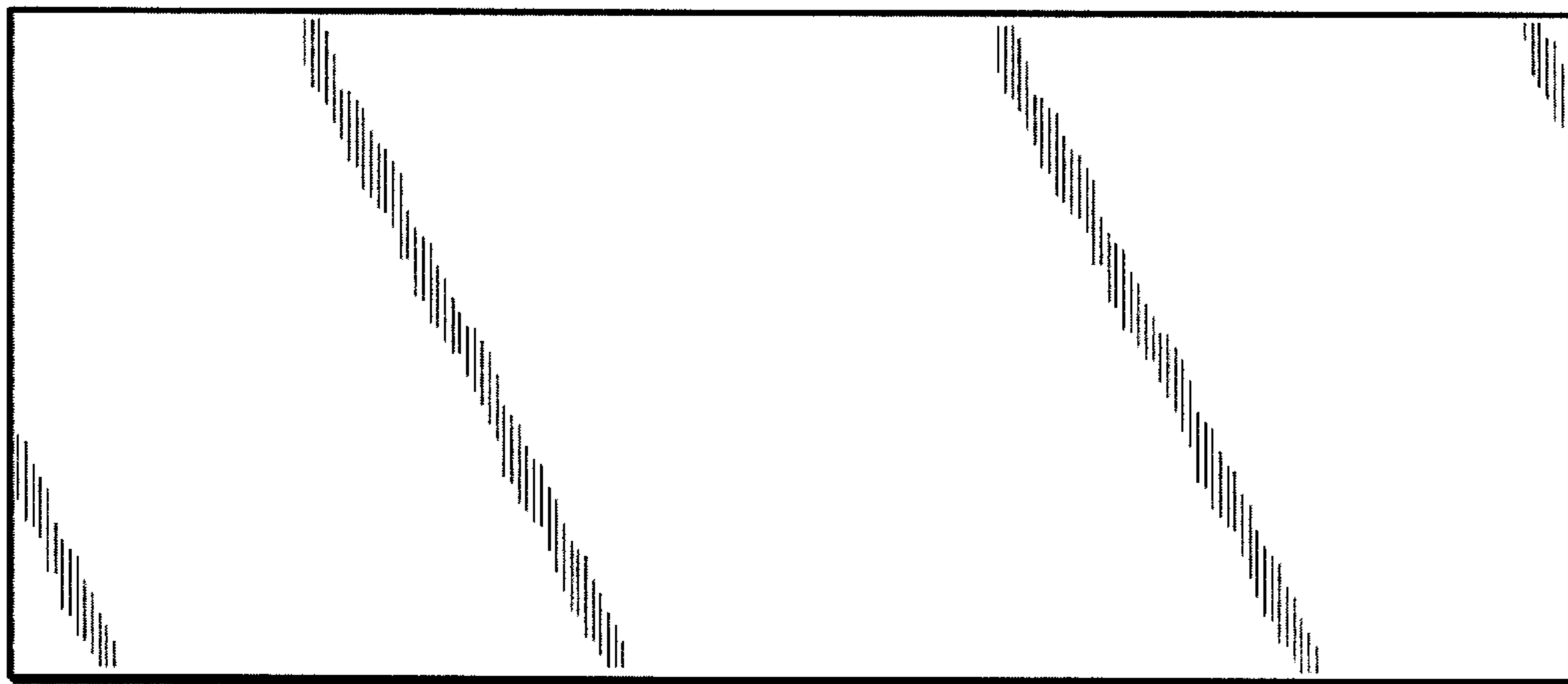
FIG. 6 is a top view thereof.

**1 Claim, 3 Drawing Sheets**

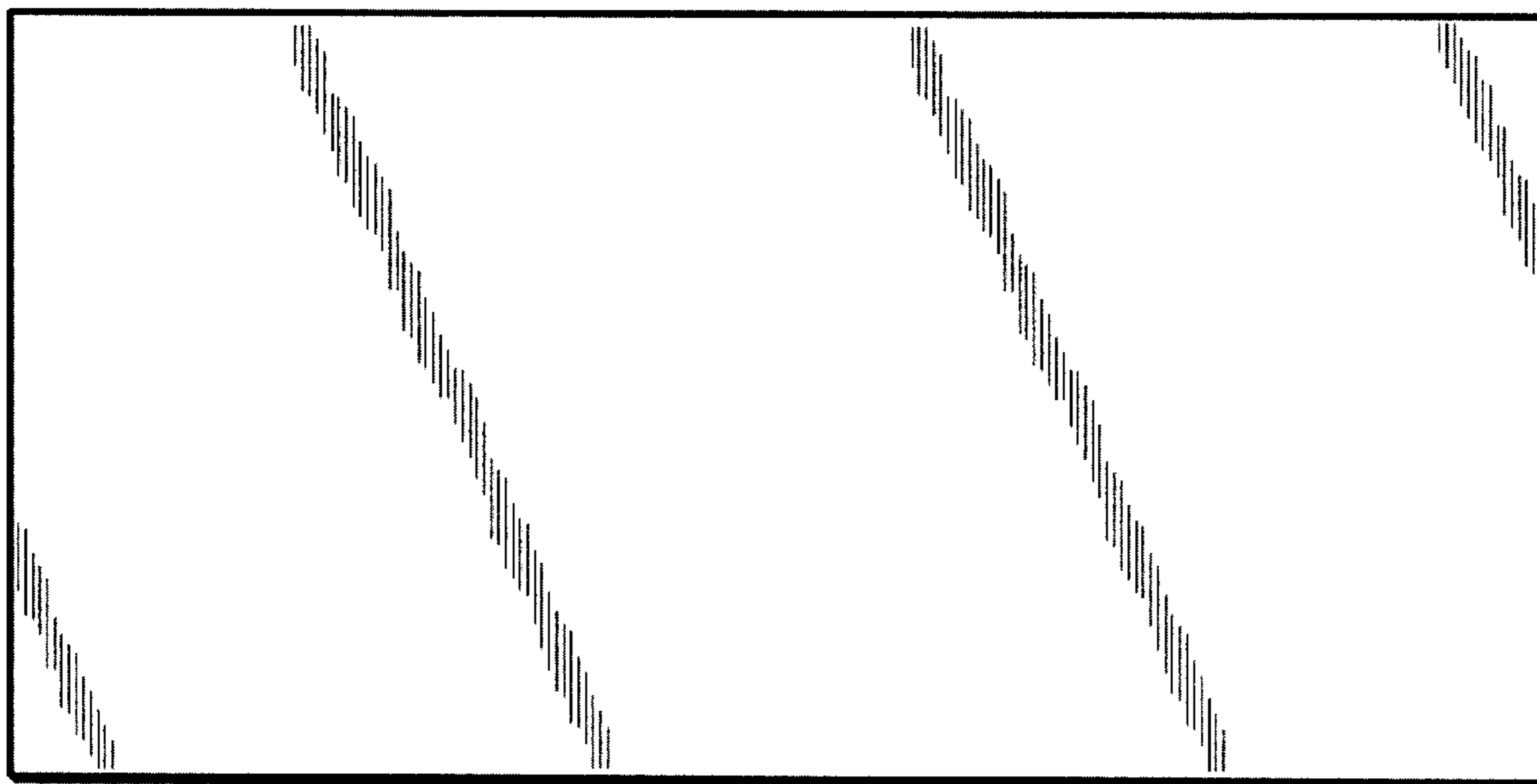




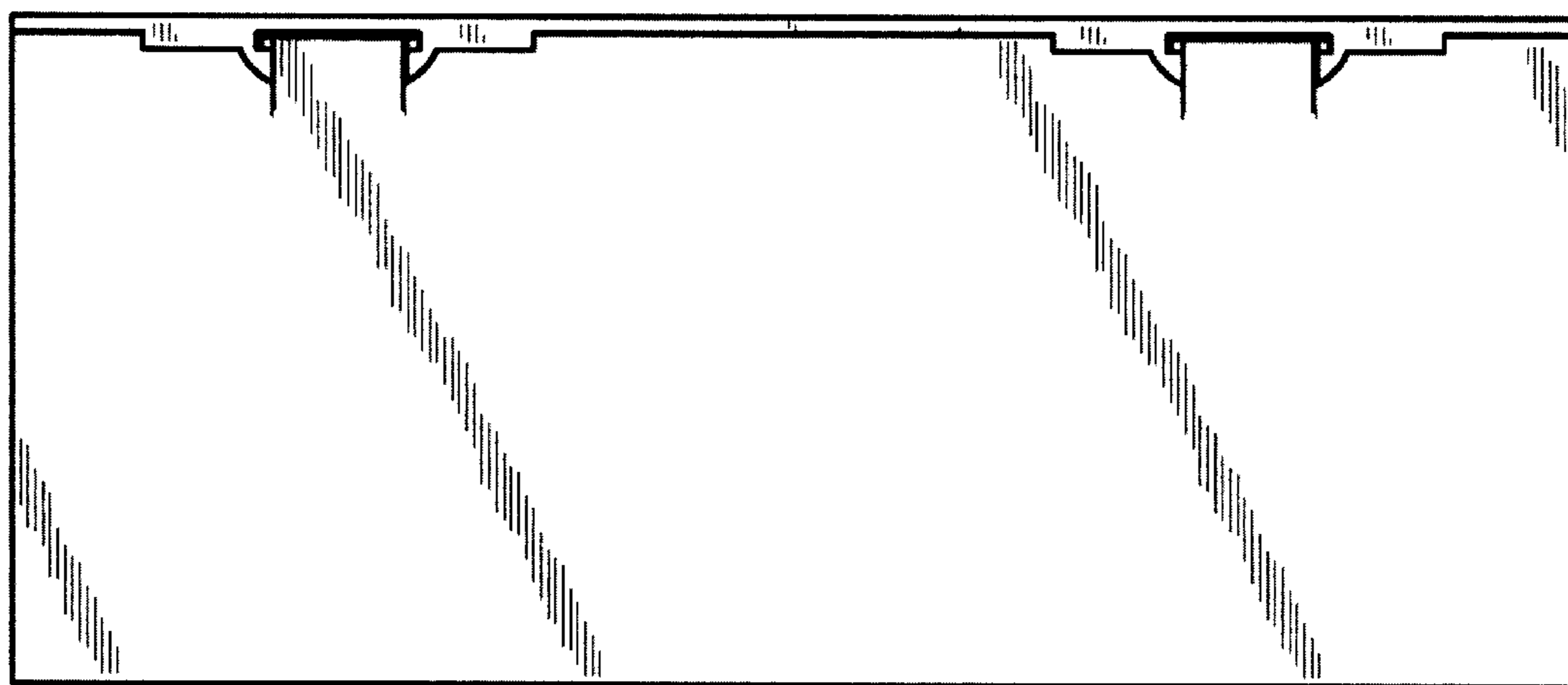
**FIG. 2**



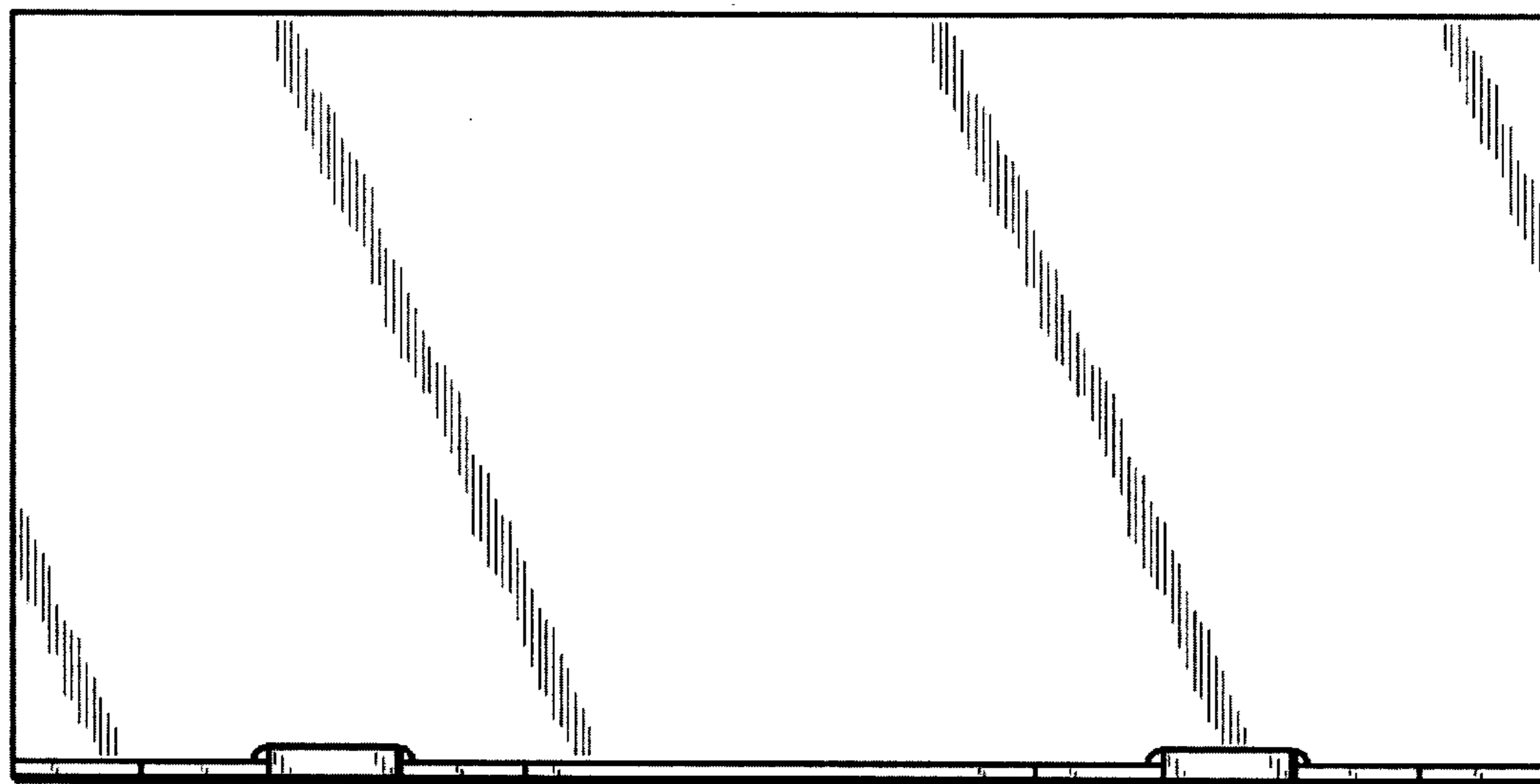
**FIG. 3**



**FIG. 4**



**FIG. 5**



**FIG. 6**