



US00D539004S

(12) **United States Design Patent**  
**Giampavolo**

(10) **Patent No.:** **US D539,004 S**

(45) **Date of Patent:** **\*\* Mar. 20, 2007**

(54) **EXTENDIBLE PALLET GUARD**

(76) **Inventor:** **Paul Giampavolo**, 10 Kingsbridge Rd.,  
Fairfield, NJ (US) 07860

(\*\*) **Term:** **14 Years**

(21) **Appl. No.:** **29/222,368**

(22) **Filed:** **Jan. 28, 2005**

(51) **LOC (8) Cl.** ..... **09-08**

(52) **U.S. Cl.** ..... **D34/38**

(58) **Field of Classification Search** ..... D34/38;  
108/53.1, 56.3, 57.26, 56.1, 51.11, 27; 40/584  
See application file for complete search history.

(56) **References Cited**

**U.S. PATENT DOCUMENTS**

3,677,436	A *	7/1972	Danielson	.....	206/595
3,904,066	A *	9/1975	Wilson	.....	220/7
5,662,048	A *	9/1997	Kralj et al.	.....	108/56.3
6,192,807	B1 *	2/2001	Mason	.....	108/51.11
6,393,788	B1 *	5/2002	Flores	.....	52/365
6,408,768	B1 *	6/2002	Giampavolo et al.	.....	108/27
6,866,160	B2 *	3/2005	Wang et al.	.....	220/7
6,892,651	B1 *	5/2005	Van Reed et al.	.....	108/56.1
7,028,964	B2 *	4/2006	Baechle	.....	248/346.01

\* cited by examiner

*Primary Examiner*—Cynthia E. Ramirez

(74) *Attorney, Agent, or Firm*—Ostrolenk, Faber, Gerb &  
Soffen, LLP

(57) **CLAIM**

The ornamental design for an extendible pallet guard, substantially as shown and described.

**DESCRIPTION**

FIG. 1 is a front view of an extendible pallet guard showing my new design;

FIG. 2 is a rear view of the design;

FIG. 3 is a rear view section of the design;

FIG. 4 is a front view section of the design;

FIG. 5 is a front view of the design with an extended panel;

FIG. 6 is a rear view of the design with an extended panel;

FIG. 7 is a rear view section of the design with an extended panel;

FIG. 8 is a front view section of two panels joined at 180° with each other;

FIG. 9 is a front perspective view of the panels of FIG. 8;

FIG. 10 is a side view of the panels of FIG. 8;

FIG. 11 is another side view of the panels of FIG. 8;

FIG. 12 is a rear perspective view of the panels of FIG. 8;

FIG. 13 is a rear view of the panels of FIG. 8;

FIG. 14 is a front perspective view of two panels joined at 90° with each other;

FIG. 15 is a top perspective view of the panels of FIG. 14; and,

FIG. 16 is a rear perspective view of the panels of FIG. 14.

The broken line showing of an additional panel in FIGS. 8 through 16 is for illustrative purposes only and forms no part of the claimed design.

The panels are partially shown in some of the figures for convenience of illustrations.

**1 Claim, 11 Drawing Sheets**

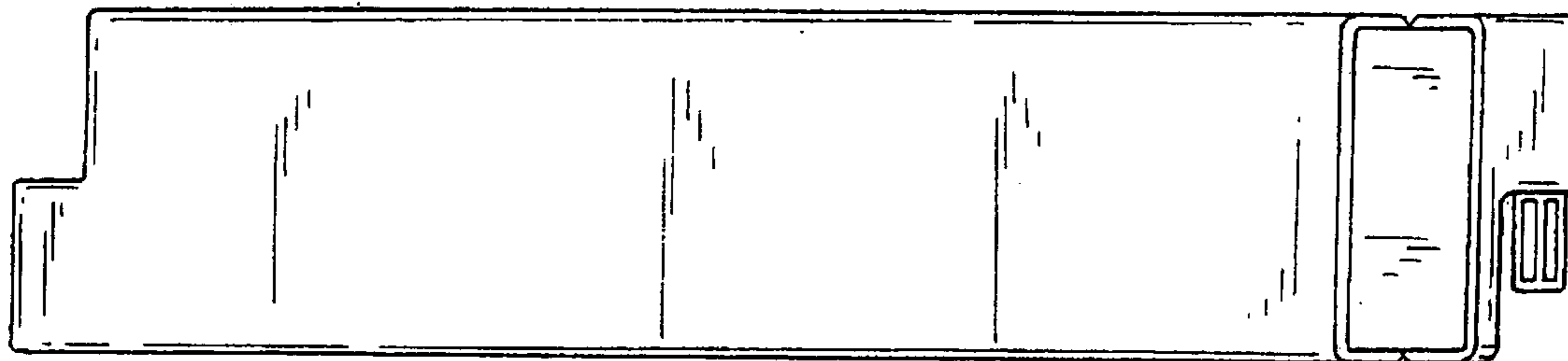

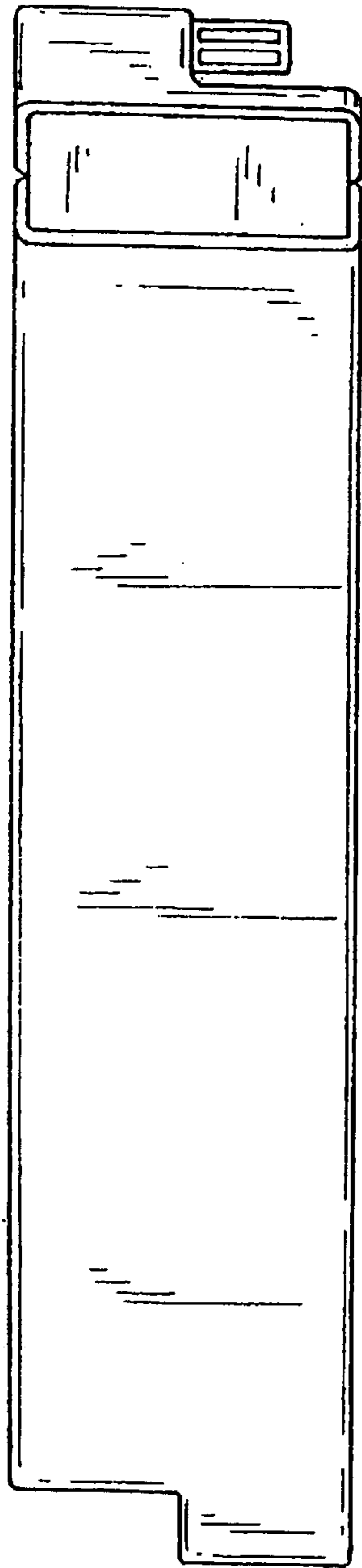

FIG. 1

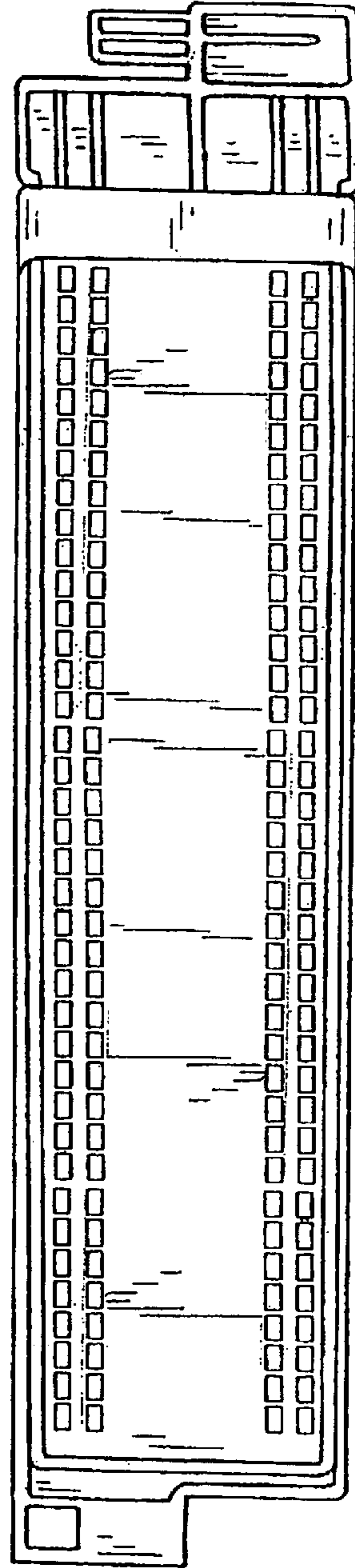

FIG. 2

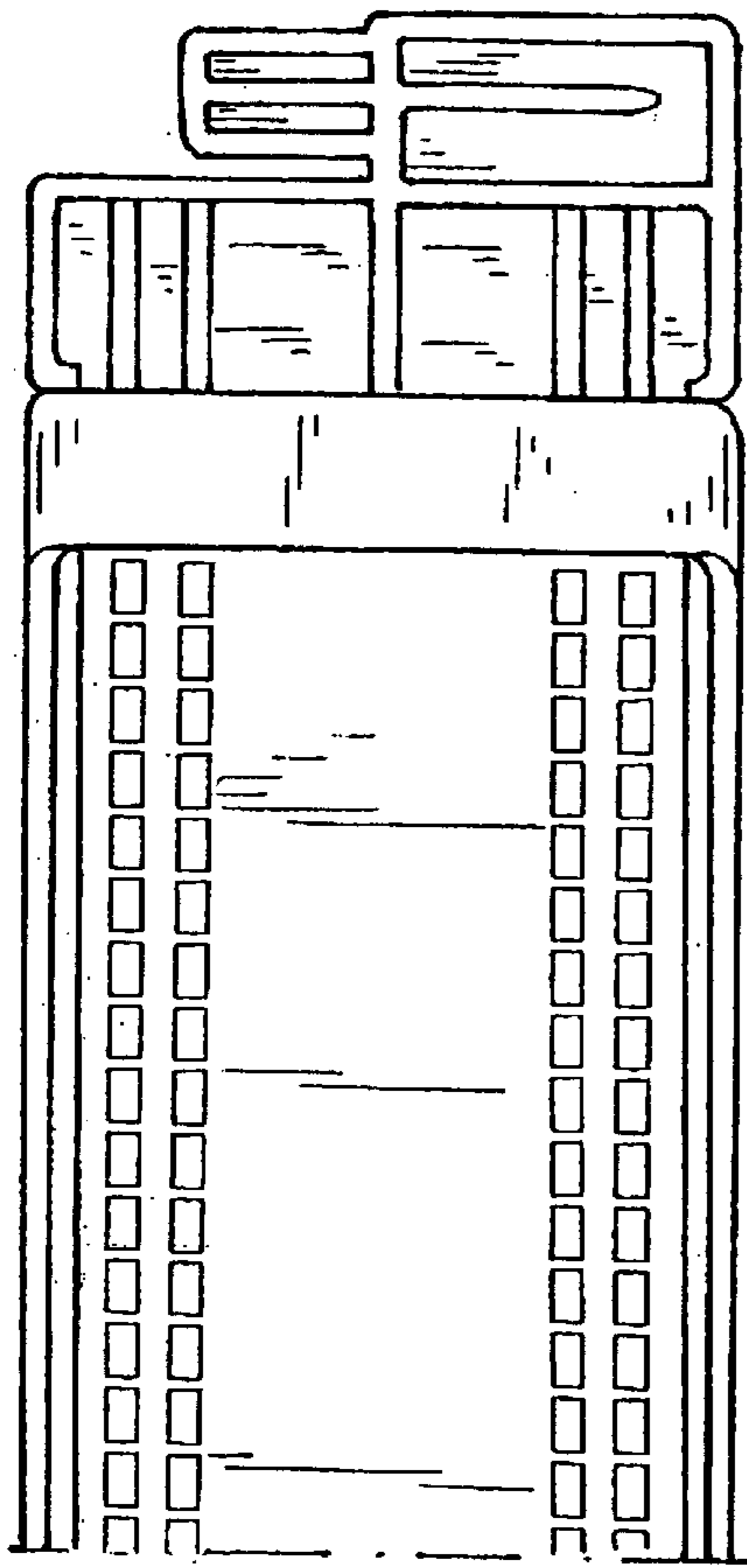

FIG. 3

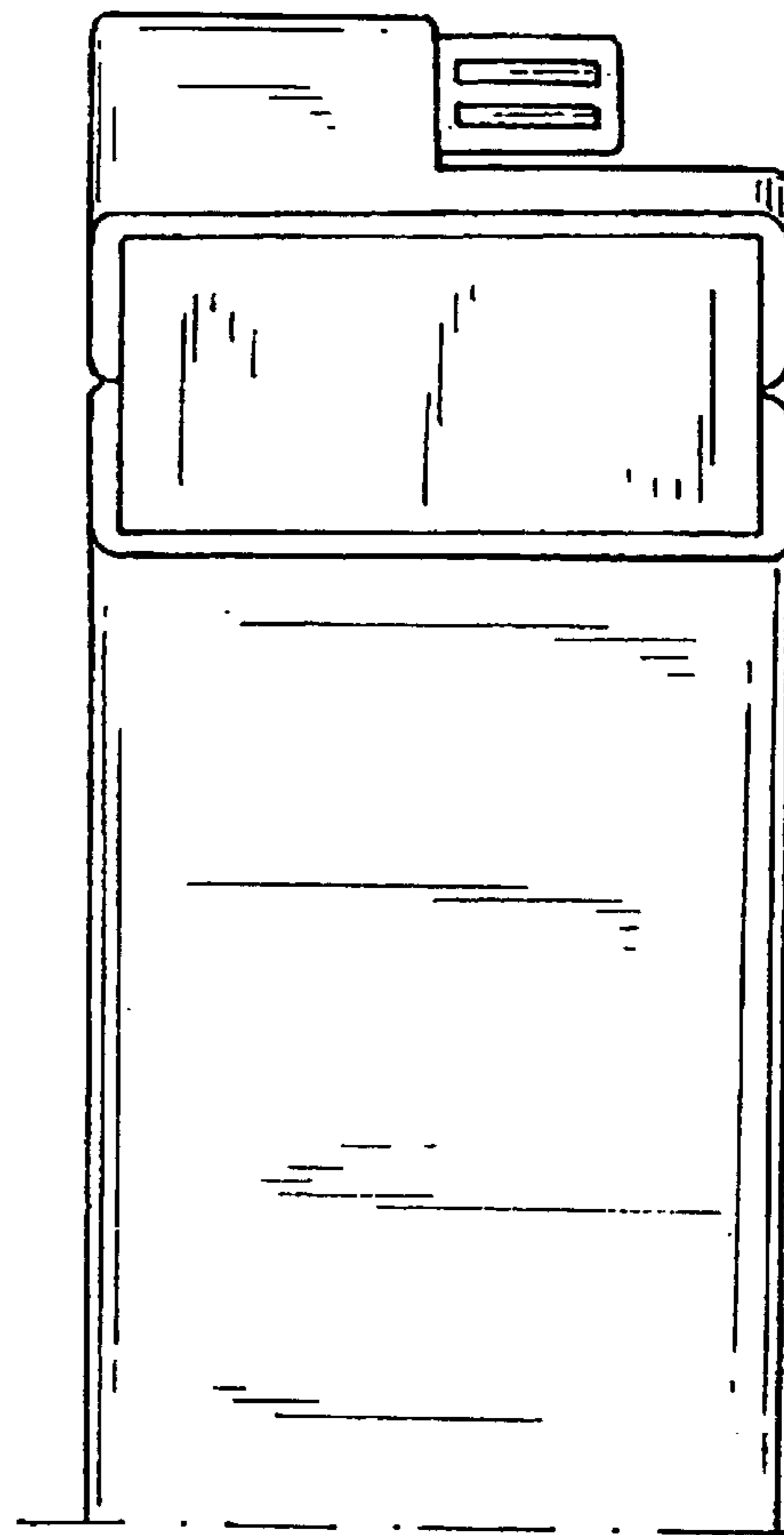

FIG. 4

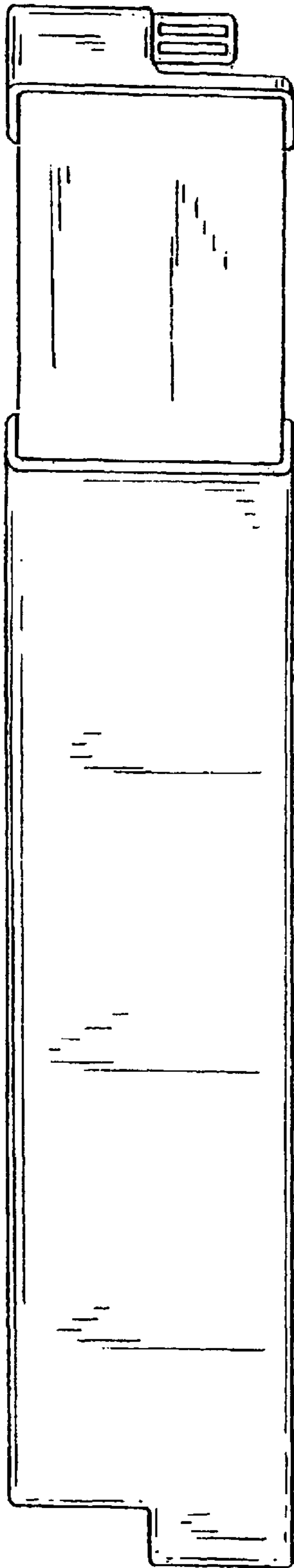

FIG. 5

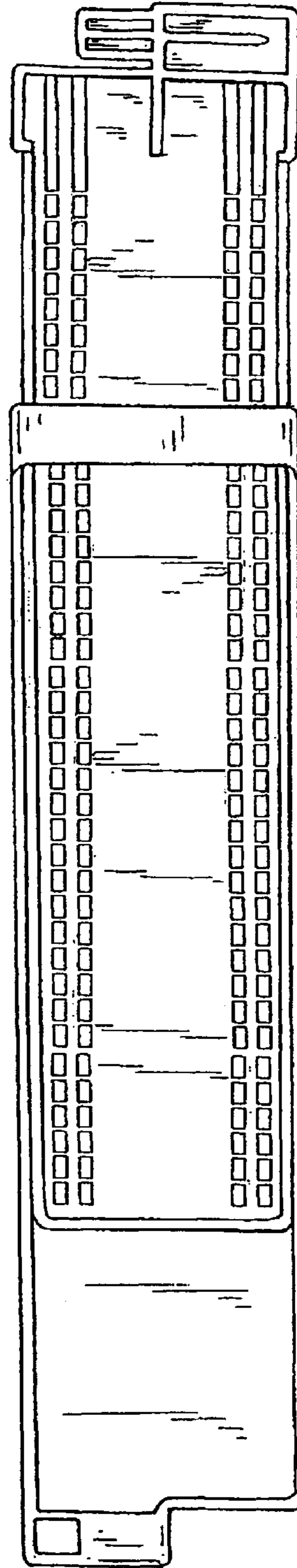

FIG. 6

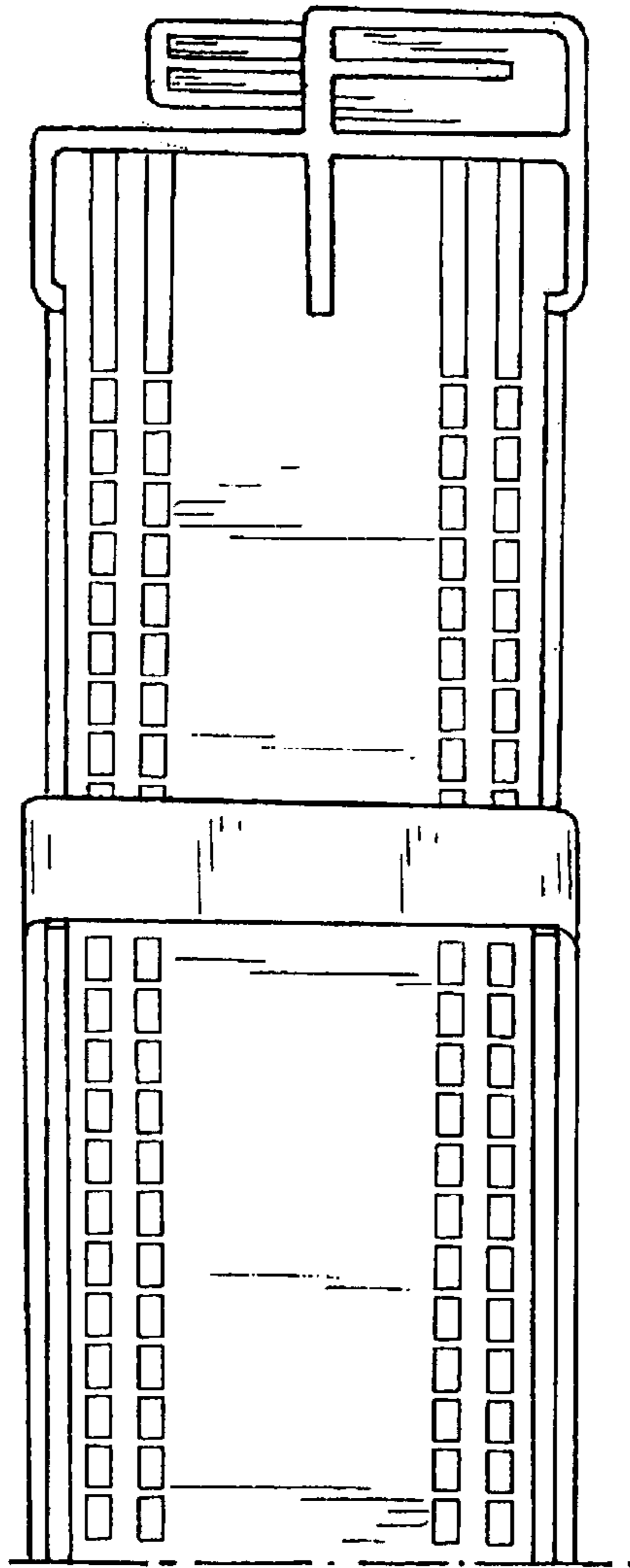

FIG. 7

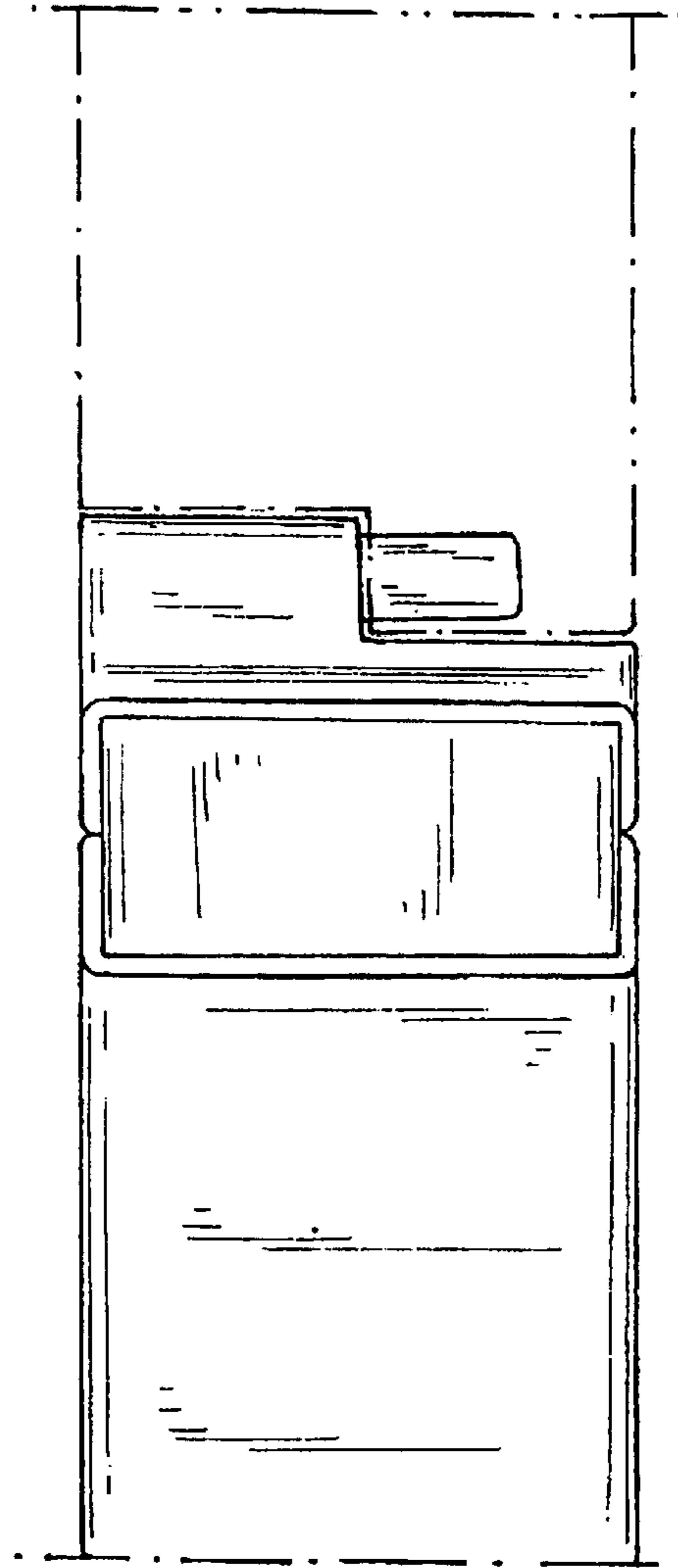

FIG. 8

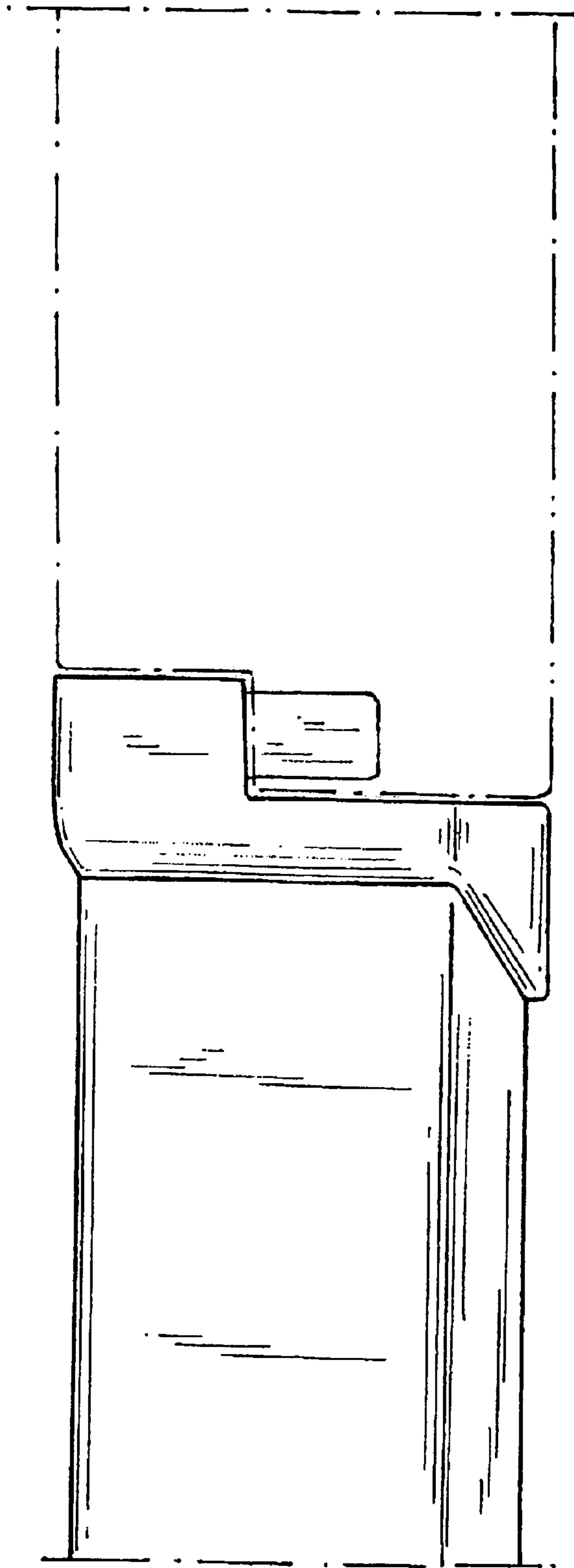

FIG. 9

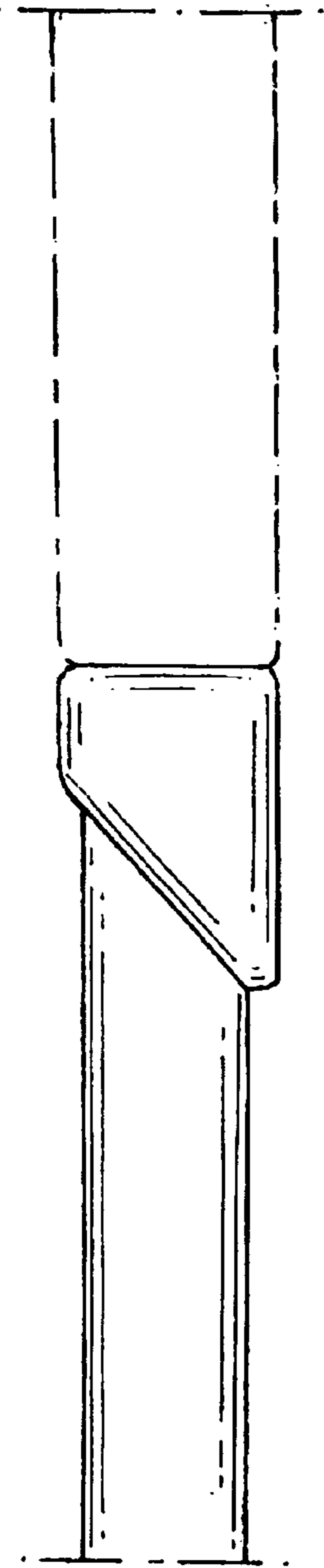

FIG. 10

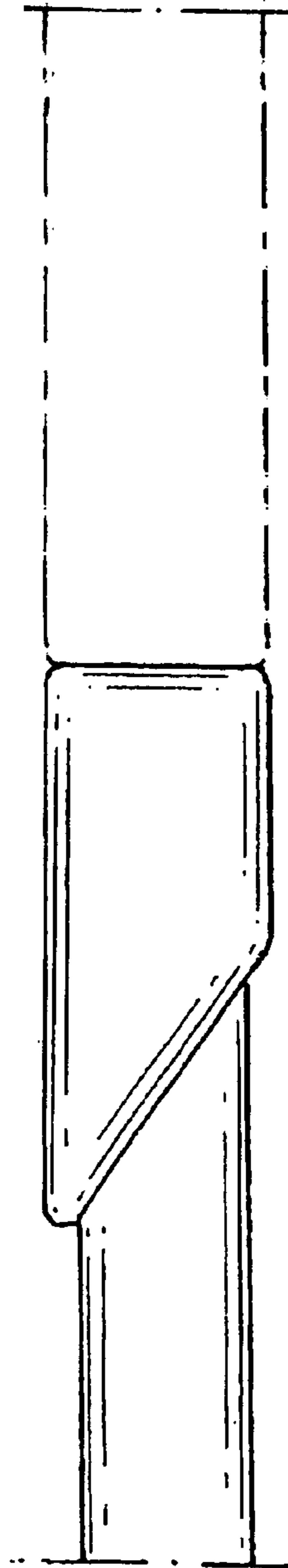

FIG. 11

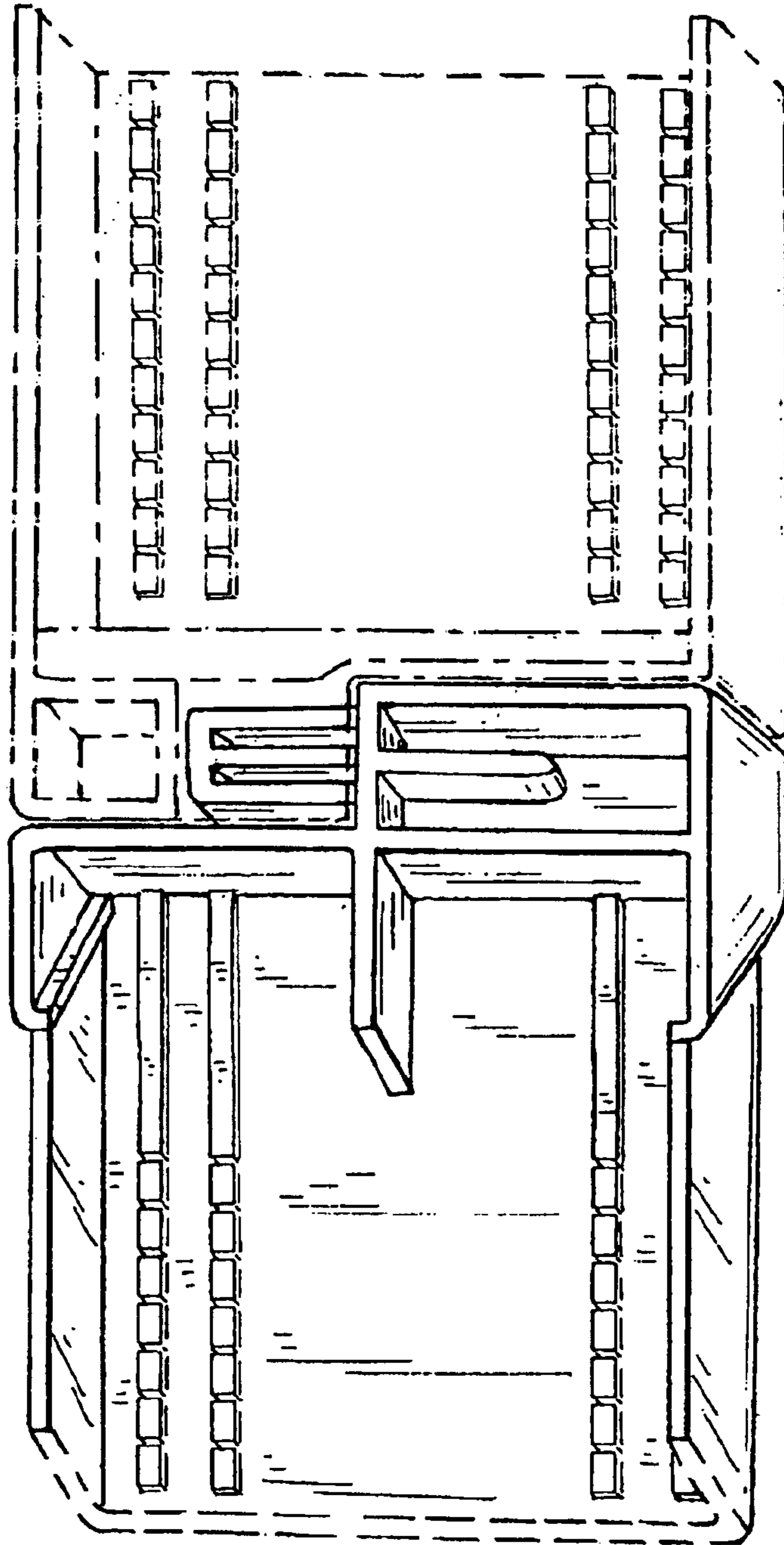

FIG. 12



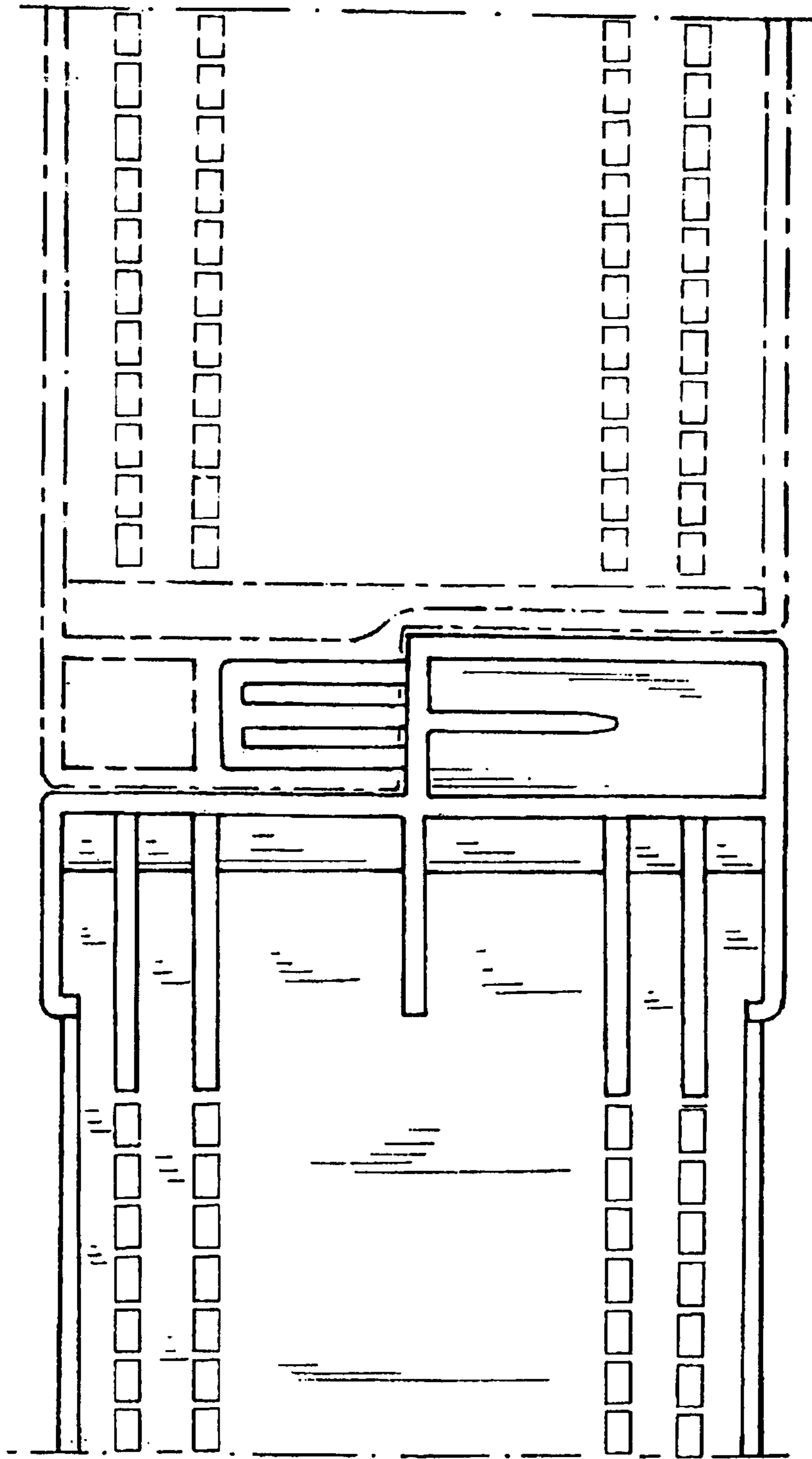

FIG. 13

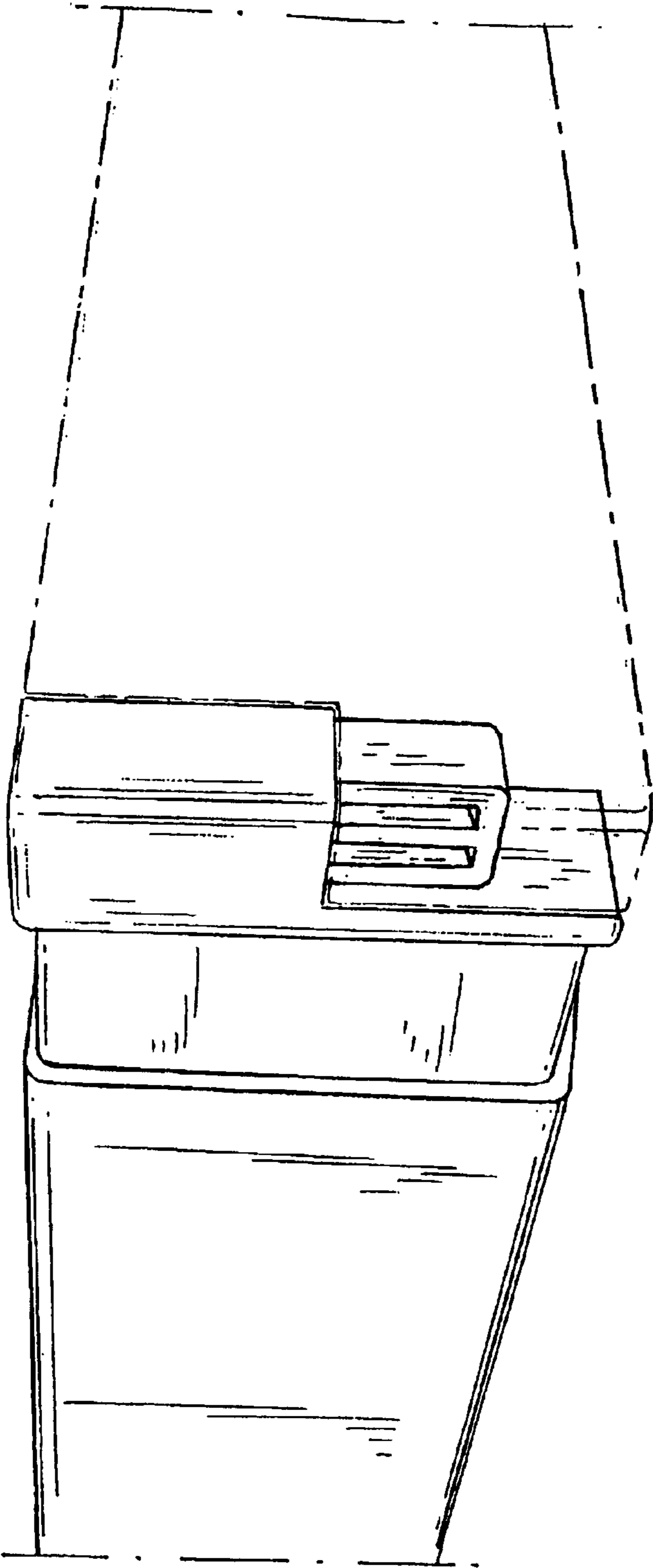

FIG. 14

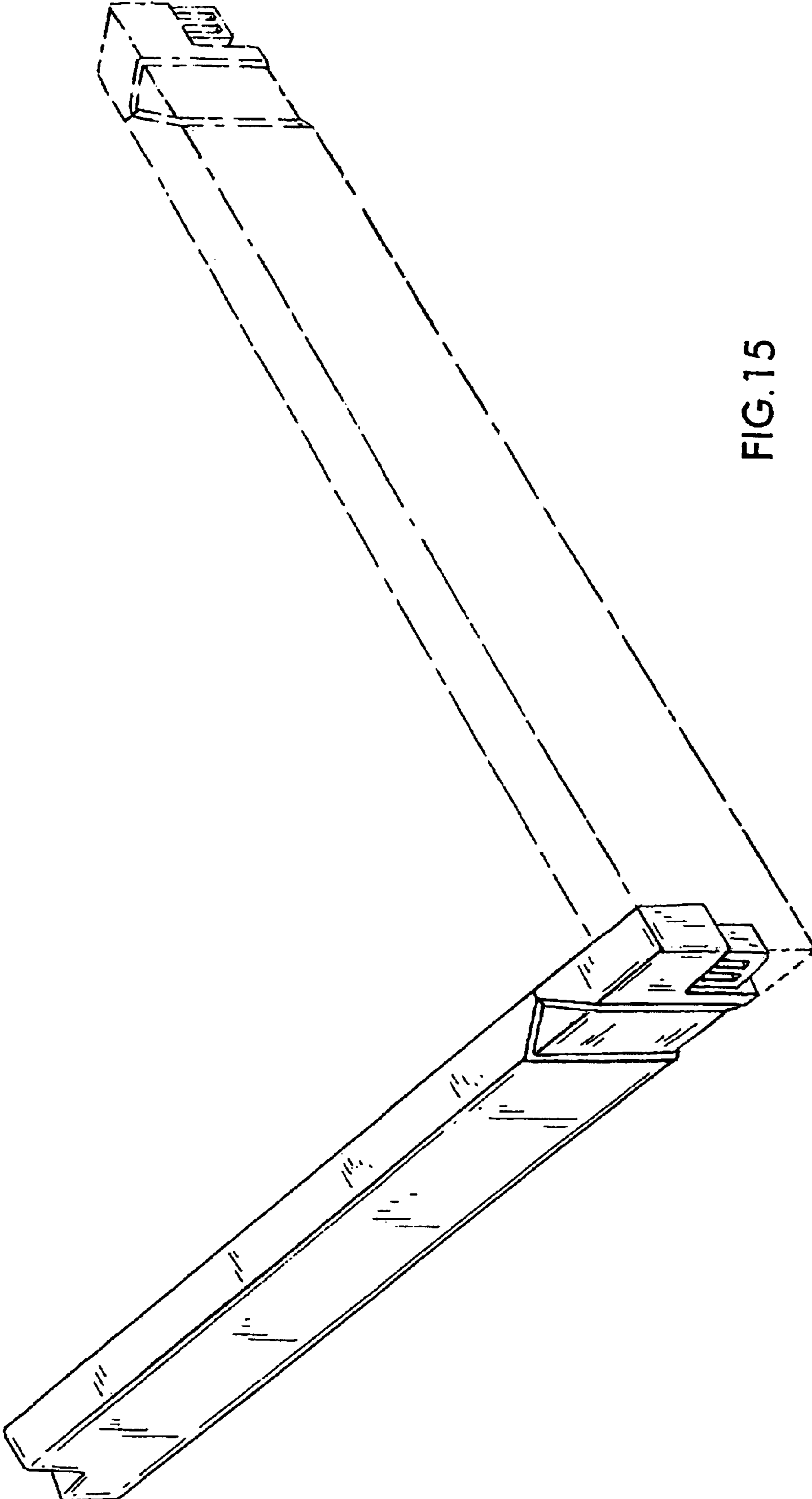

FIG. 15

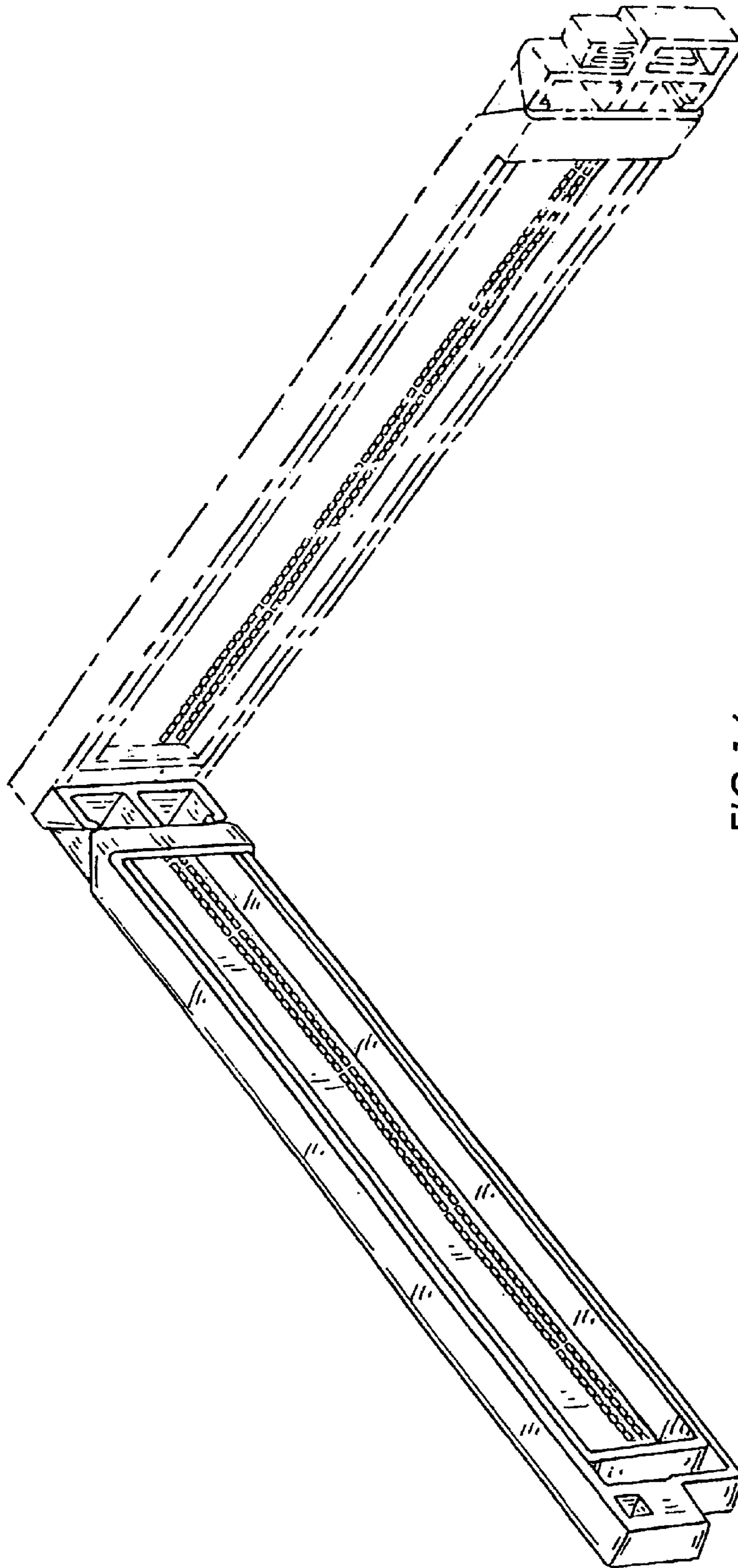

FIG. 16