



US00D538972S

(12) **United States Design Patent**  
**Smith**

(10) **Patent No.:** **US D538,972 S**

(45) **Date of Patent:** **\*\* Mar. 20, 2007**

(54) **LIGHTER**

D508,144 S \* 8/2005 Xu ..... D27/157  
D526,440 S \* 8/2006 Smith ..... D27/157

(75) Inventor: **Andrew D. Smith**, Pascoag, RI (US)

\* cited by examiner

(73) Assignee: **Colibri Corporation**, Providence, RI (US)

*Primary Examiner*—Jennifer Rivard  
(74) *Attorney, Agent, or Firm*—Salter & Michaelson

(\*\*) Term: **14 Years**

(57) **CLAIM**

(21) Appl. No.: **29/259,573**

The ornamental design for a lighter, as shown.

(22) Filed: **May 11, 2006**

**DESCRIPTION**

(51) **LOC (8) Cl.** ..... **27-05**

(52) **U.S. Cl.** ..... **D27/157; D27/159**

(58) **Field of Classification Search** ..... D27/141–161;  
431/129, 143, 153, 253–256, 273–277  
See application file for complete search history.

FIG. 1 is a perspective view of a lighter showing my new design;  
FIG. 2 is a front elevational view thereof;  
FIG. 3 is a rear elevational view thereof;  
FIG. 4 is a left side elevational view thereof;  
FIG. 5 is a right side elevational view thereof;  
FIG. 6 is a top plan view thereof;  
FIG. 7 is a bottom plan view thereof; and,  
FIG. 8 is a left side elevational view thereof with the cover open.

(56) **References Cited**

**U.S. PATENT DOCUMENTS**

D485,938 S \* 1/2004 Smith ..... D27/157  
D494,707 S \* 8/2004 Fontaine ..... D27/141  
D498,873 S \* 11/2004 Fontaine ..... D27/143

**1 Claim, 4 Drawing Sheets**

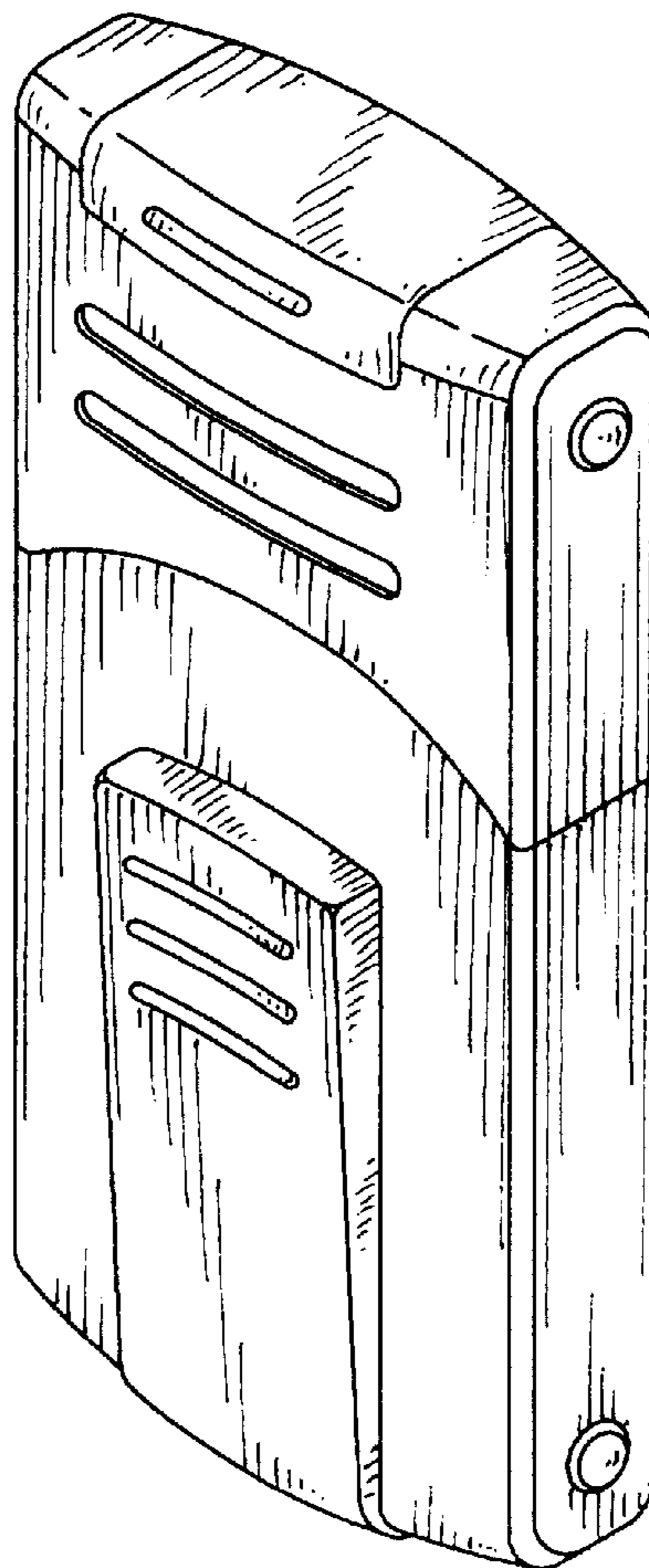

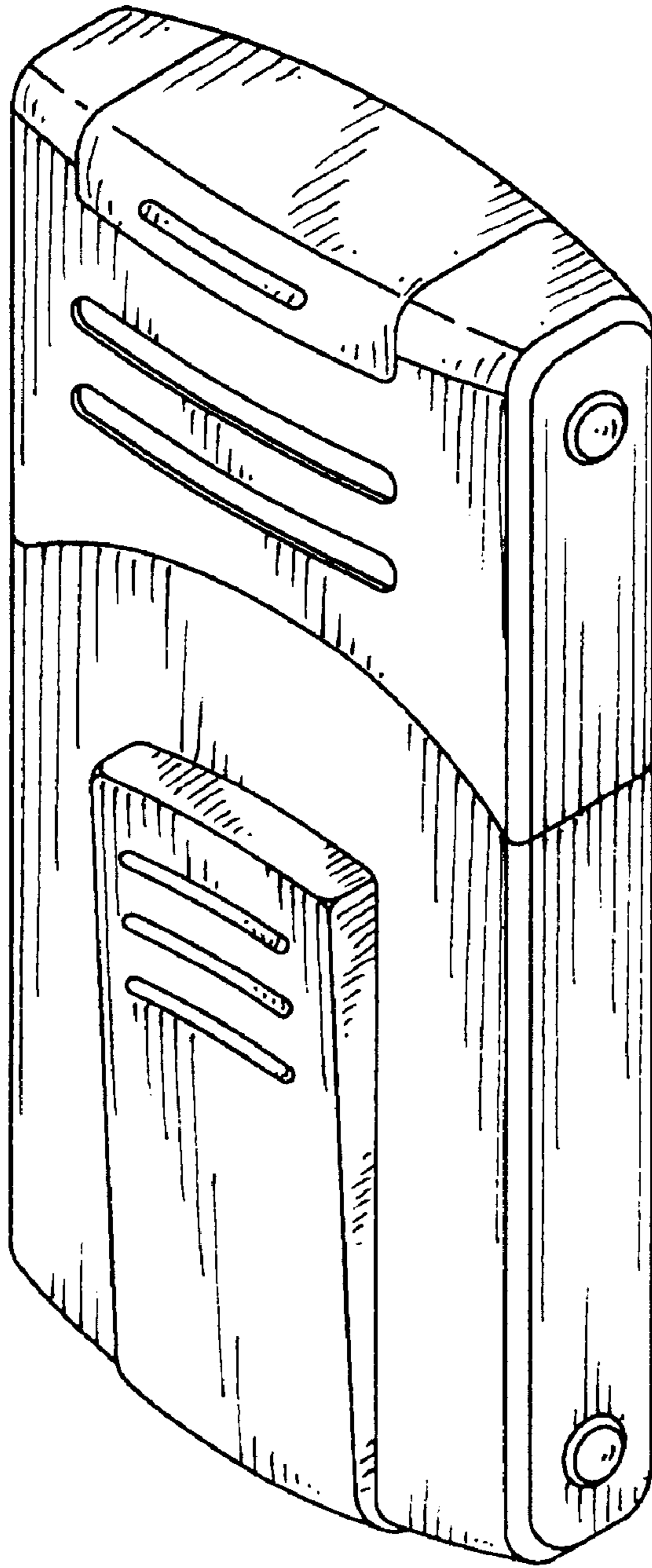

FIG. 1

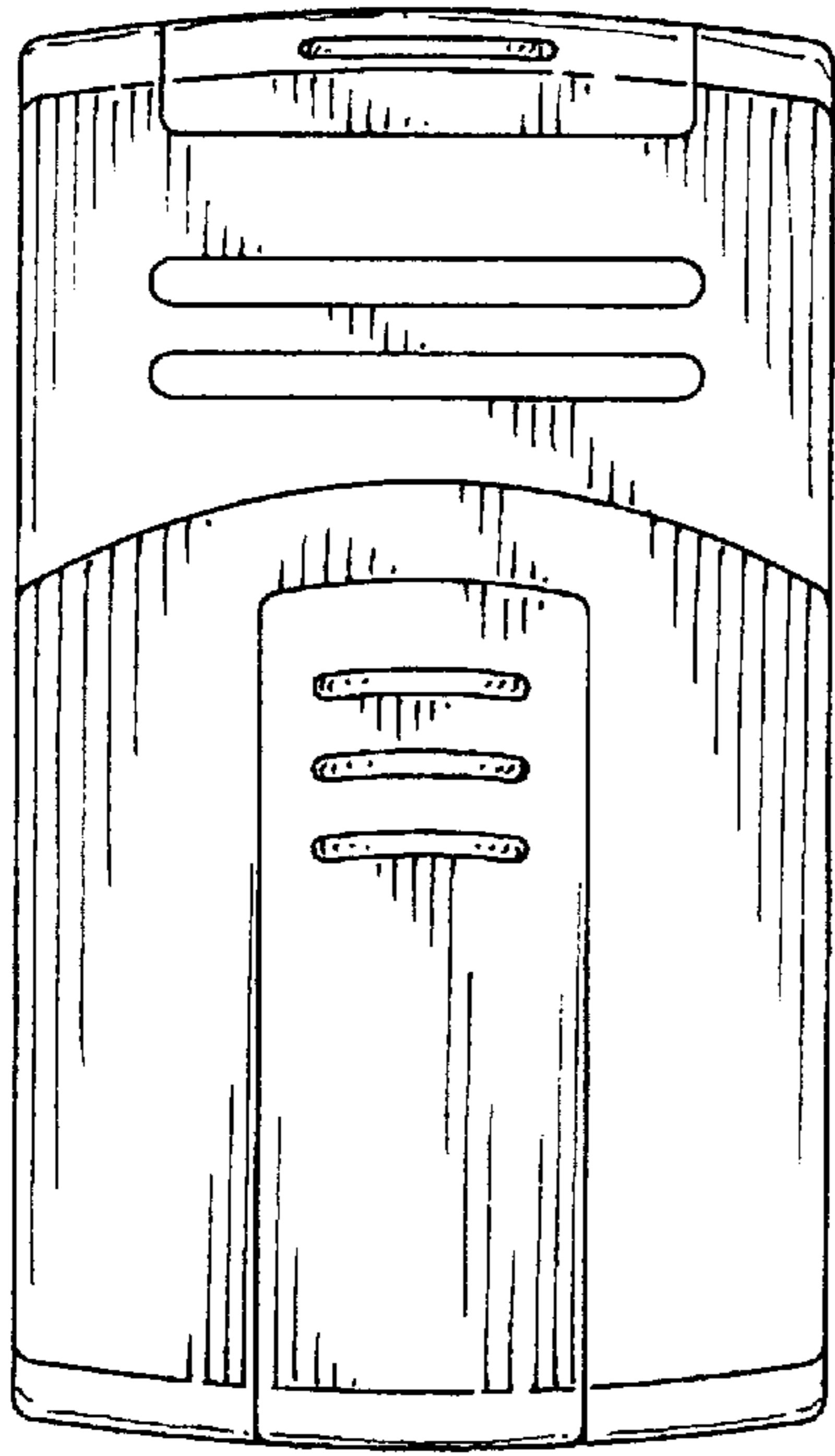

FIG. 2

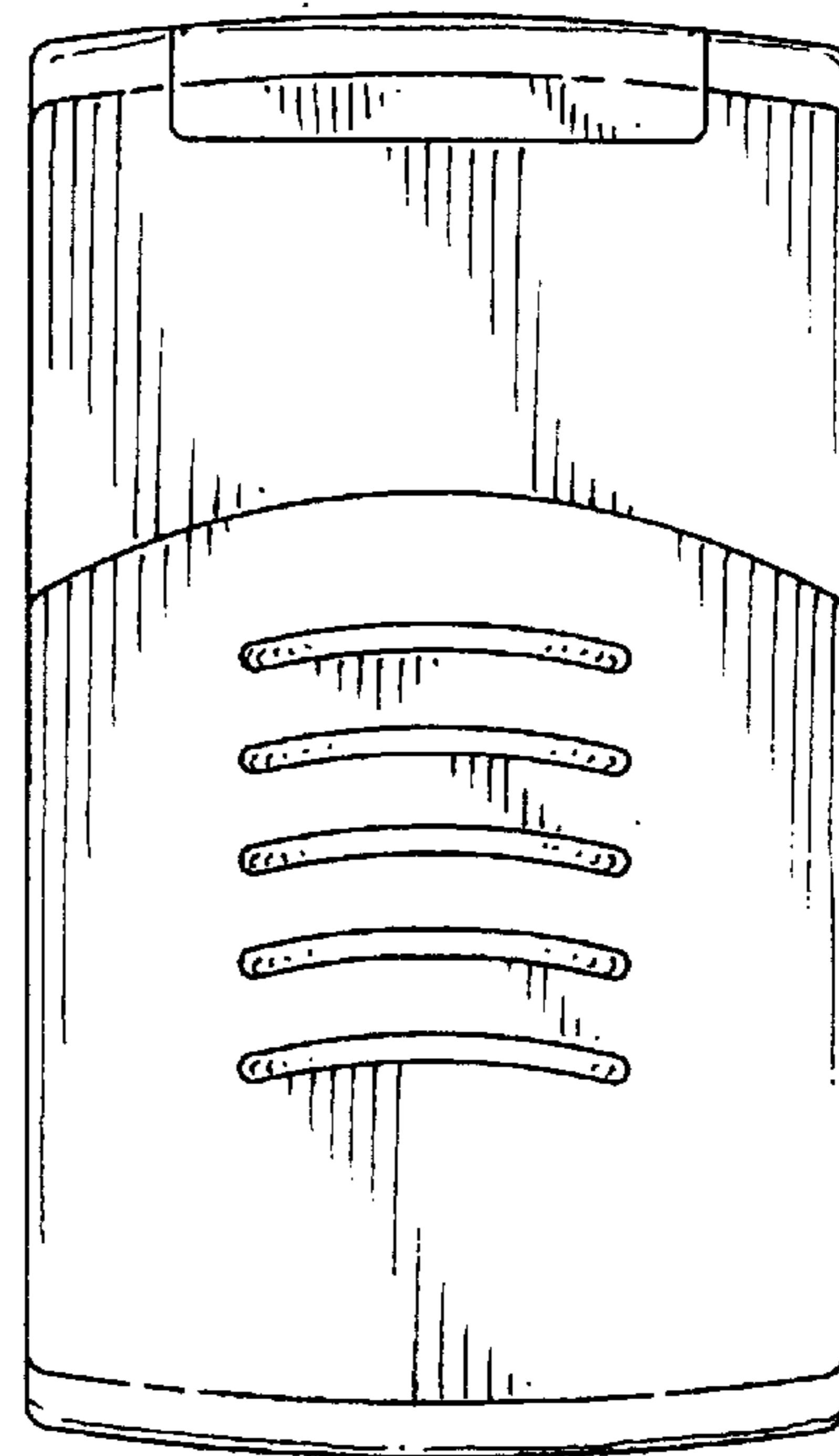

FIG. 3

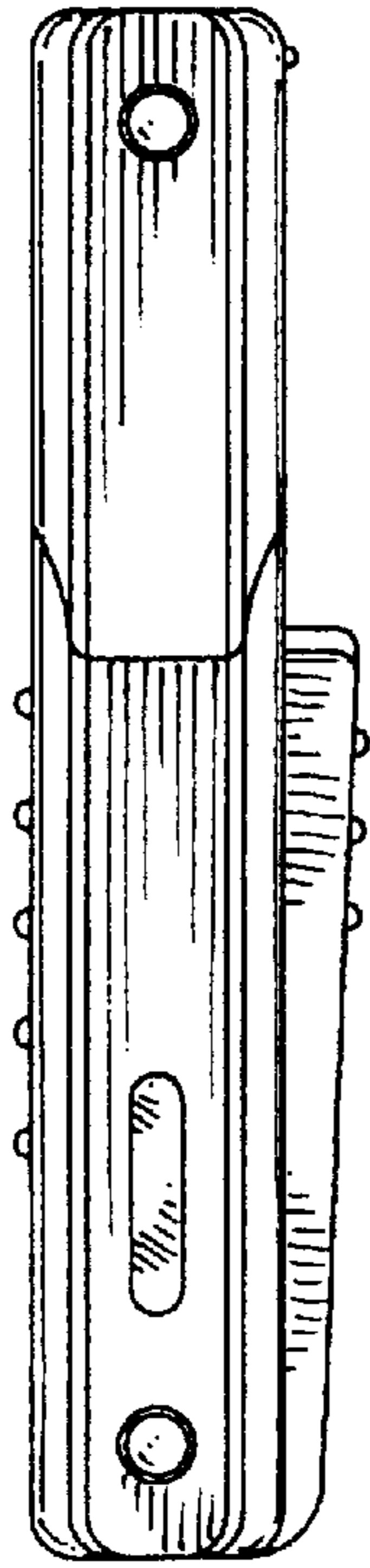

FIG. 4

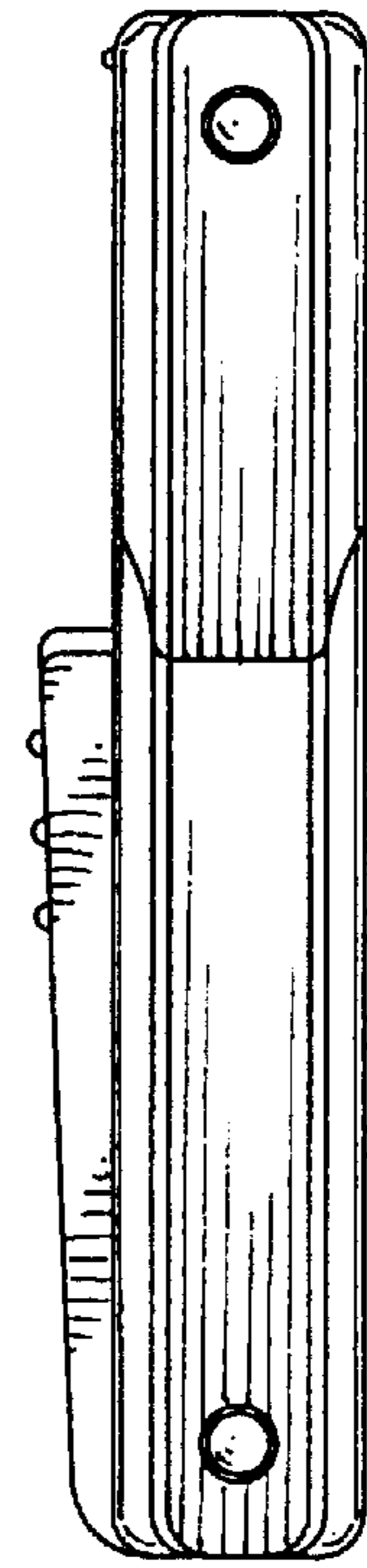

FIG. 5

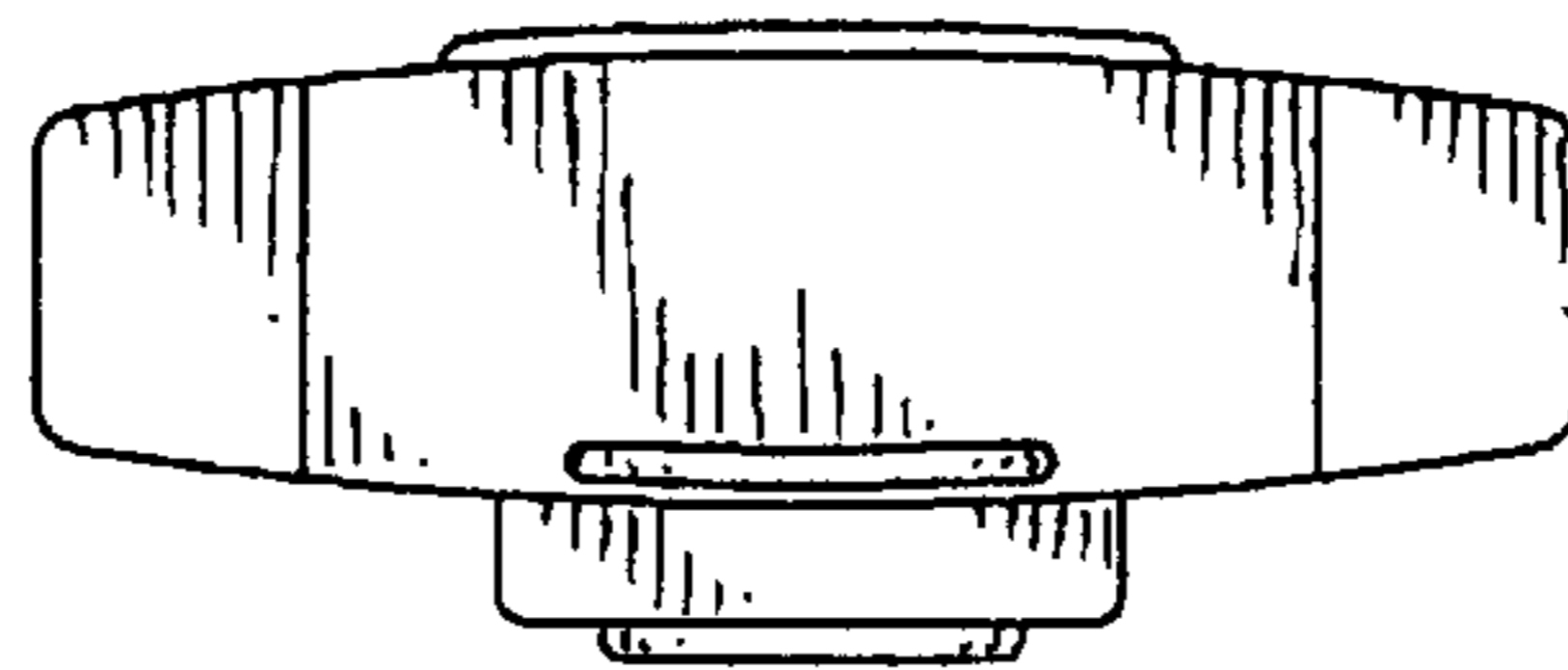

FIG. 6

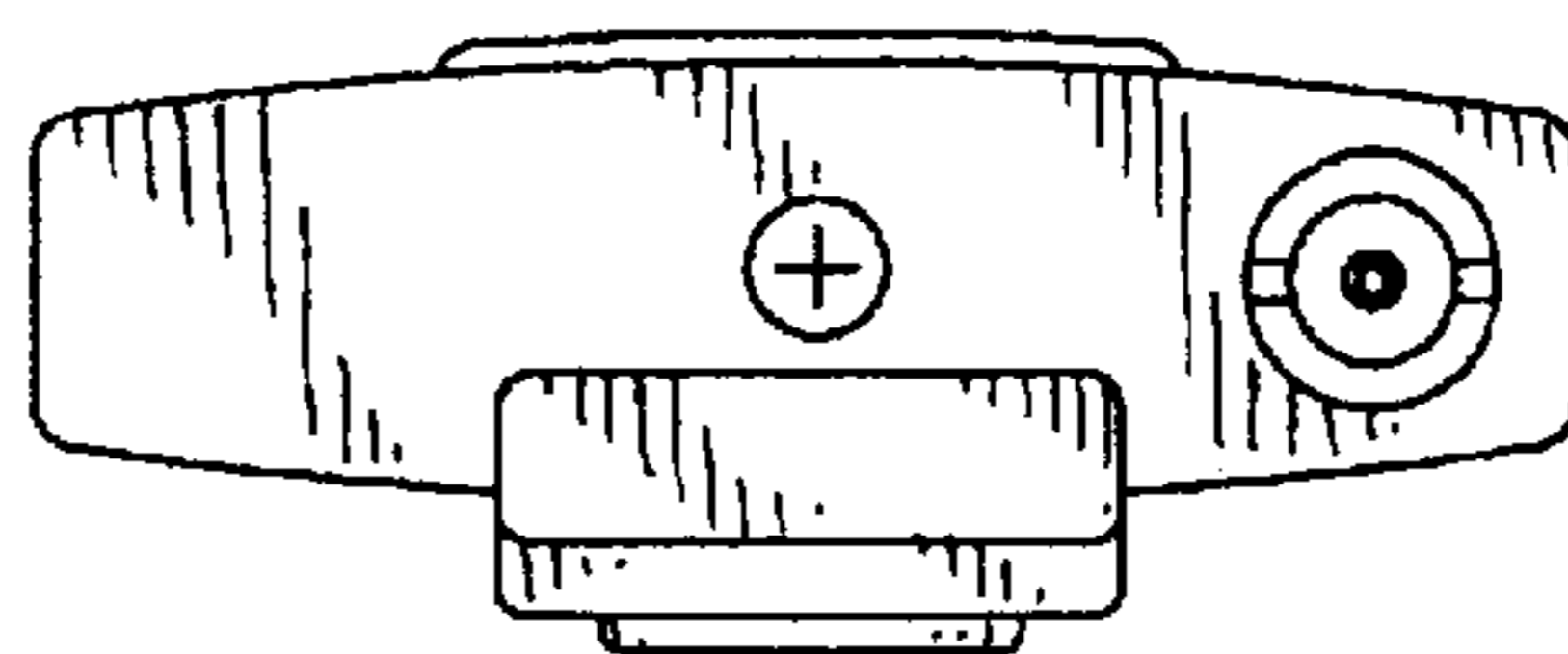

FIG. 7

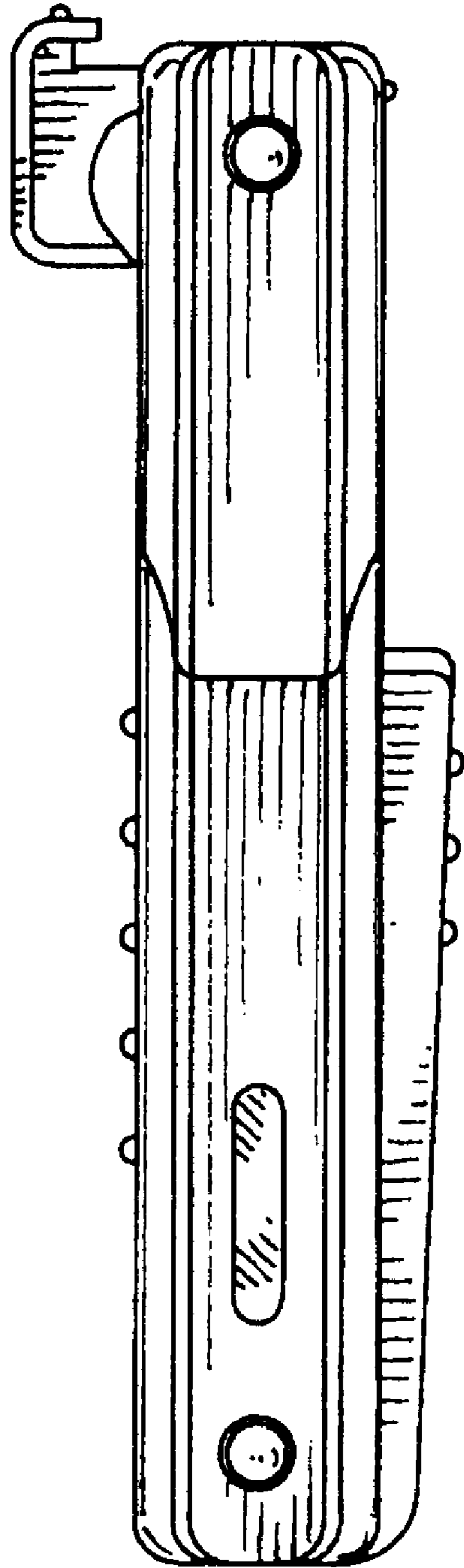

FIG. 8