



US00D538625S

(12) **United States Design Patent**
Chen

(10) **Patent No.:** **US D538,625 S**

(45) **Date of Patent:** **** Mar. 20, 2007**

(54) **TROWEL HANDLE**

D519,012 S * 4/2006 Miller D8/45

(75) Inventor: **Timmy Chen**, Taichung (TW)

* cited by examiner

(73) Assignee: **Plus Craft Industrial Co., Ltd.**,
Taichung (TW)

Primary Examiner—Alan P. Douglas

Assistant Examiner—Barbara Fox

(**) Term: **14 Years**

(74) *Attorney, Agent, or Firm*—Alan D. Kamrath; Nikolai
& Mersereau, P.A.

(21) Appl. No.: **29/235,454**

(57) **CLAIM**

(22) Filed: **Aug. 2, 2005**

The ornamental design for a trowel handle, as shown and
described.

(51) **LOC (8) Cl.** **08-05**

(52) **U.S. Cl.** **D8/107**

(58) **Field of Classification Search** D8/45,
D8/47, 300, 303, 107, DIG. 7, DIG. 8, 75-81,
D8/88-89; D7/393, 395, 401.2, 642, 664,
D7/695; D21/756; 81/177.2; 16/430, 431,
16/427, 429

DESCRIPTION

See application file for complete search history.

FIG. 1 is a perspective view of a trowel handle showing my
design;

FIG. 2 is a front elevational view thereof;

FIG. 3 is a rear elevational view thereof;

FIG. 4 is a left side elevational view thereof;

FIG. 5 is a right side elevational view thereof;

FIG. 6 is a top plan view thereof,

FIG. 7 is a bottom plan view thereof; and,

FIG. 8 is a perspective schematic view illustrating a trowel
handle showing my design disposed on a trowel. The broken
lines shown in the drawings are for illustrative purposes only
and form no part of the claimed design.

(56) **References Cited**

U.S. PATENT DOCUMENTS

1,763,066 A * 6/1930 Rooney 15/235.8

2,076,836 A * 4/1937 Goldblatt 16/110.1

5,713,096 A * 2/1998 Kelsay et al. 15/235.4

6,513,199 B1 * 2/2003 Cheng 16/436

1 Claim, 6 Drawing Sheets

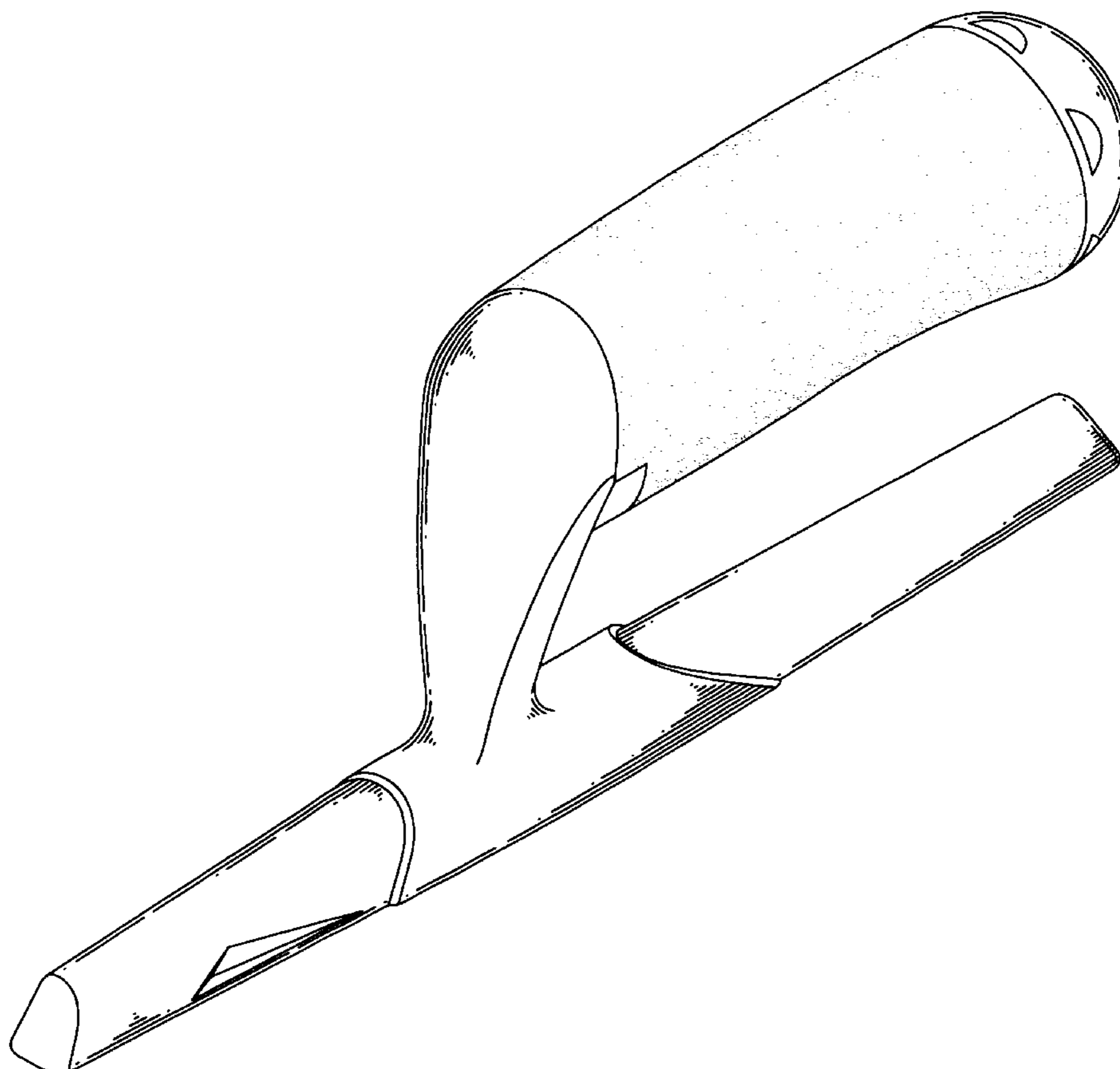

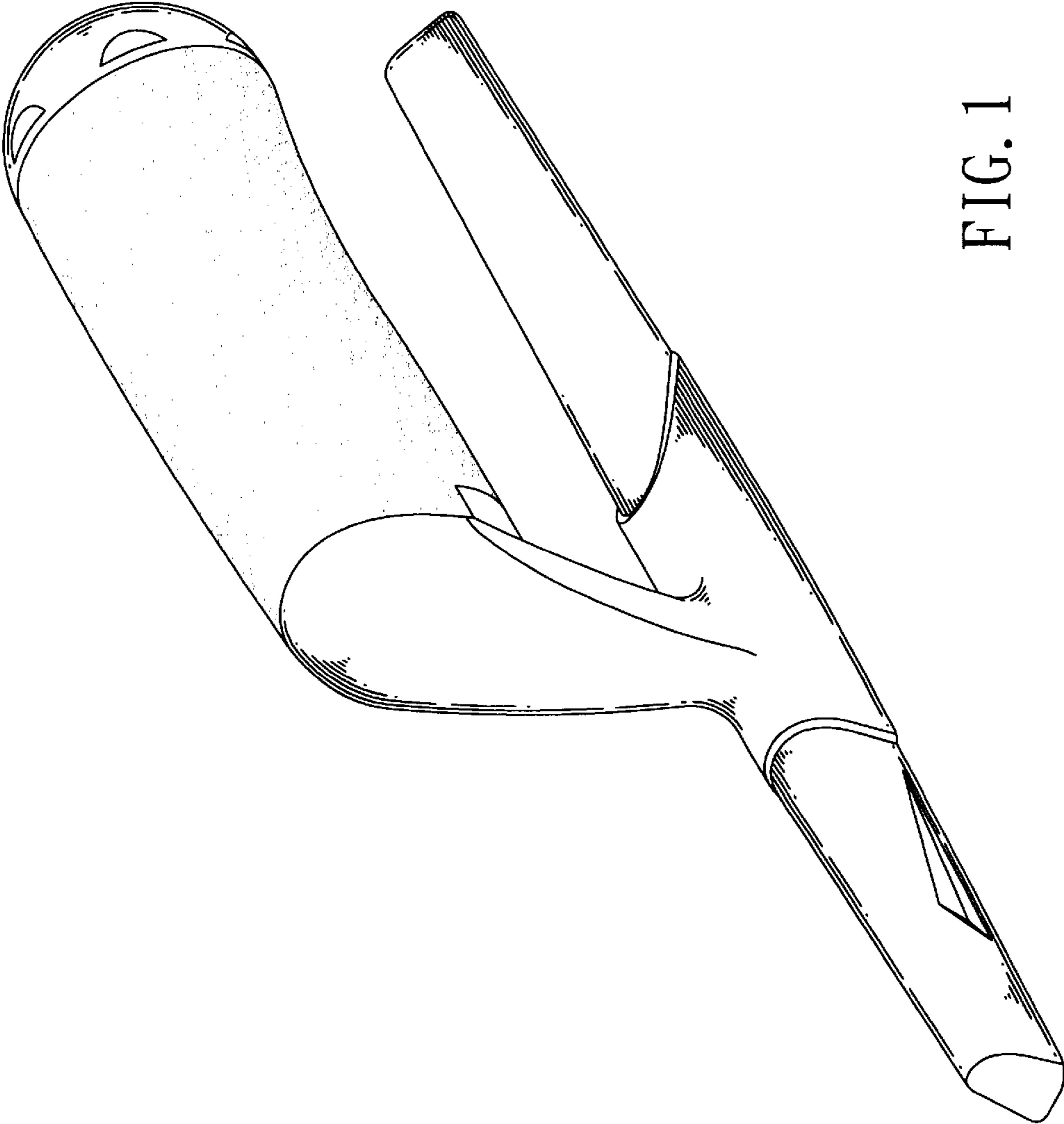

FIG. 1

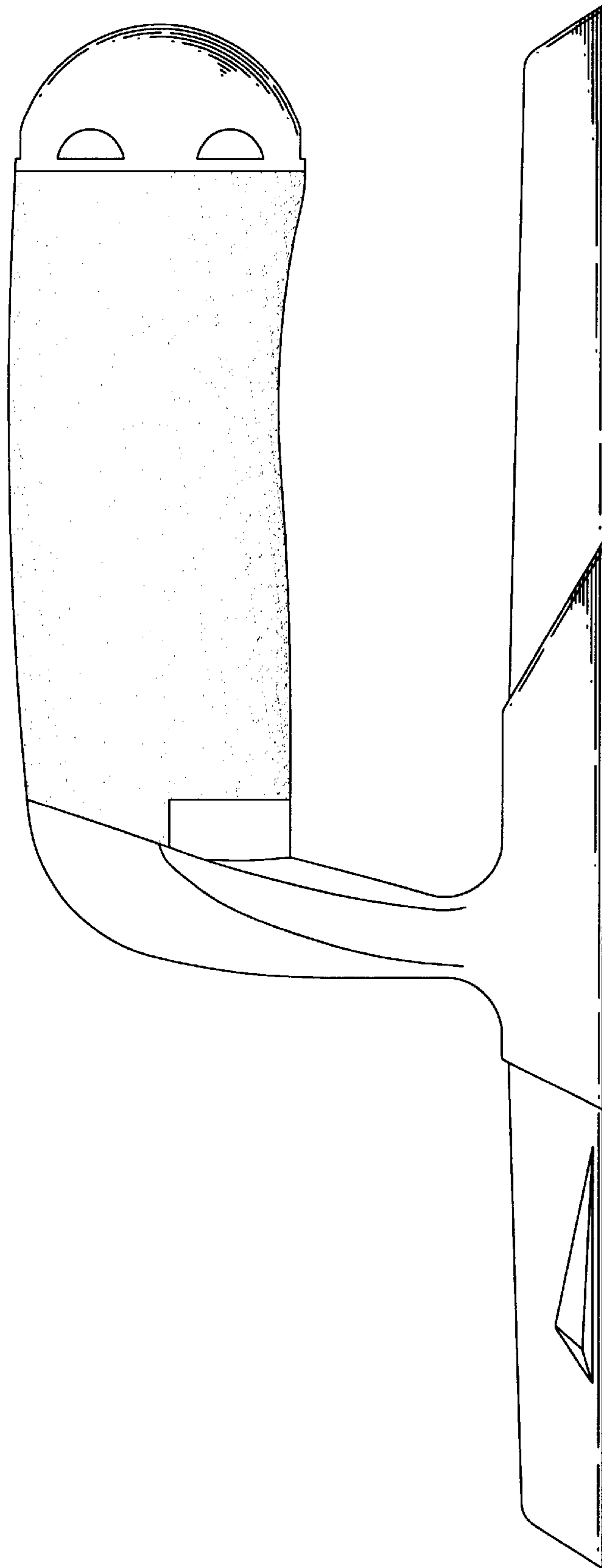

FIG. 2

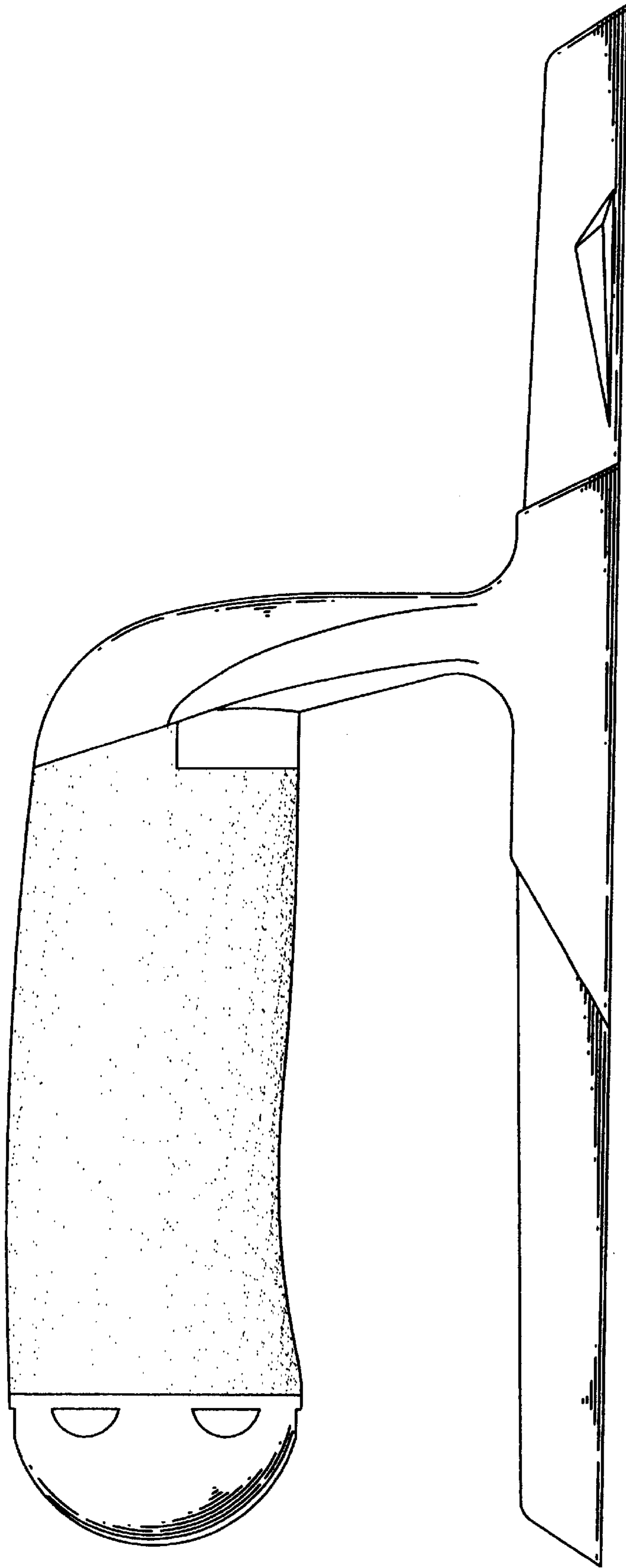

FIG. 3

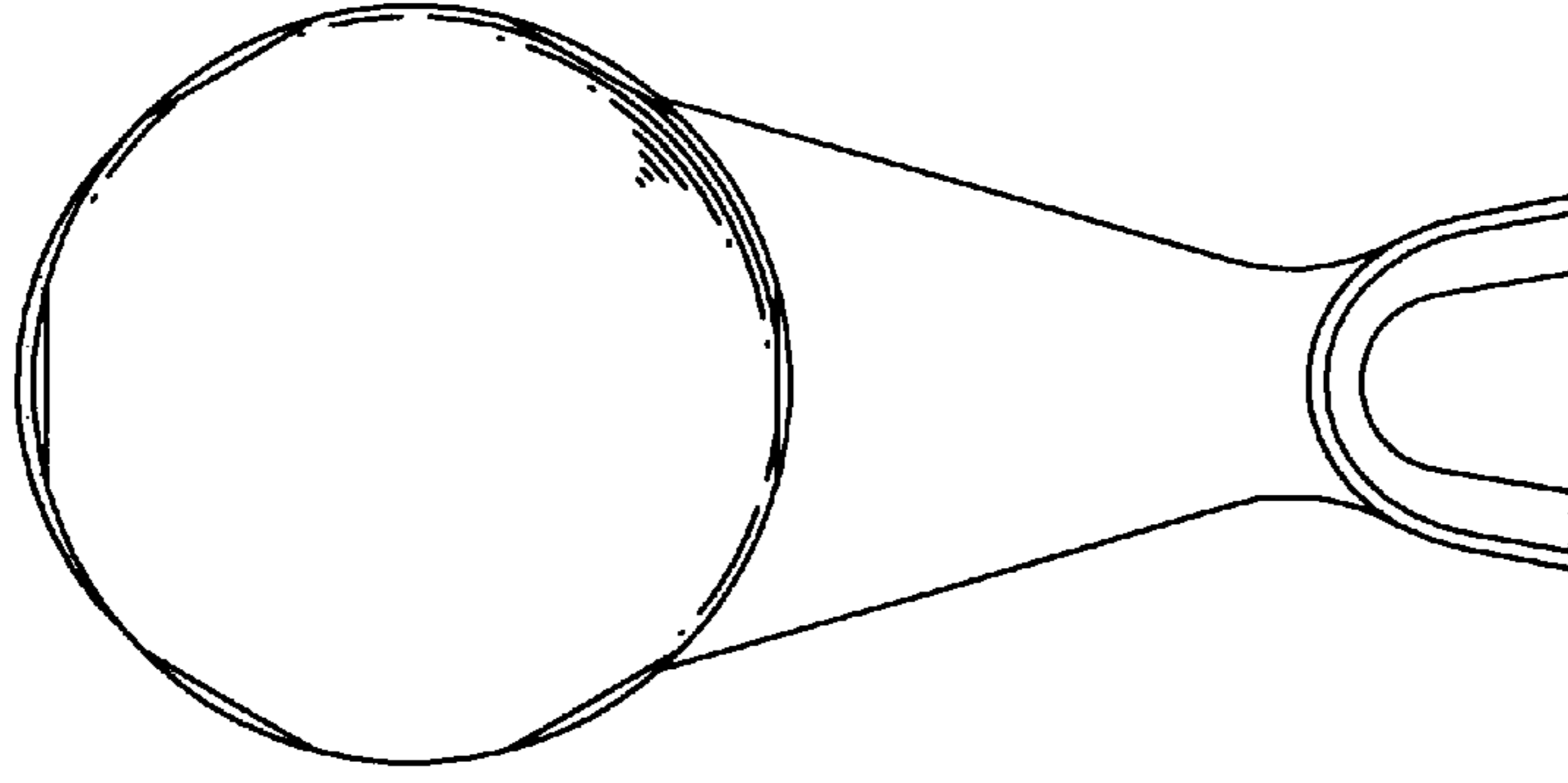

FIG. 5

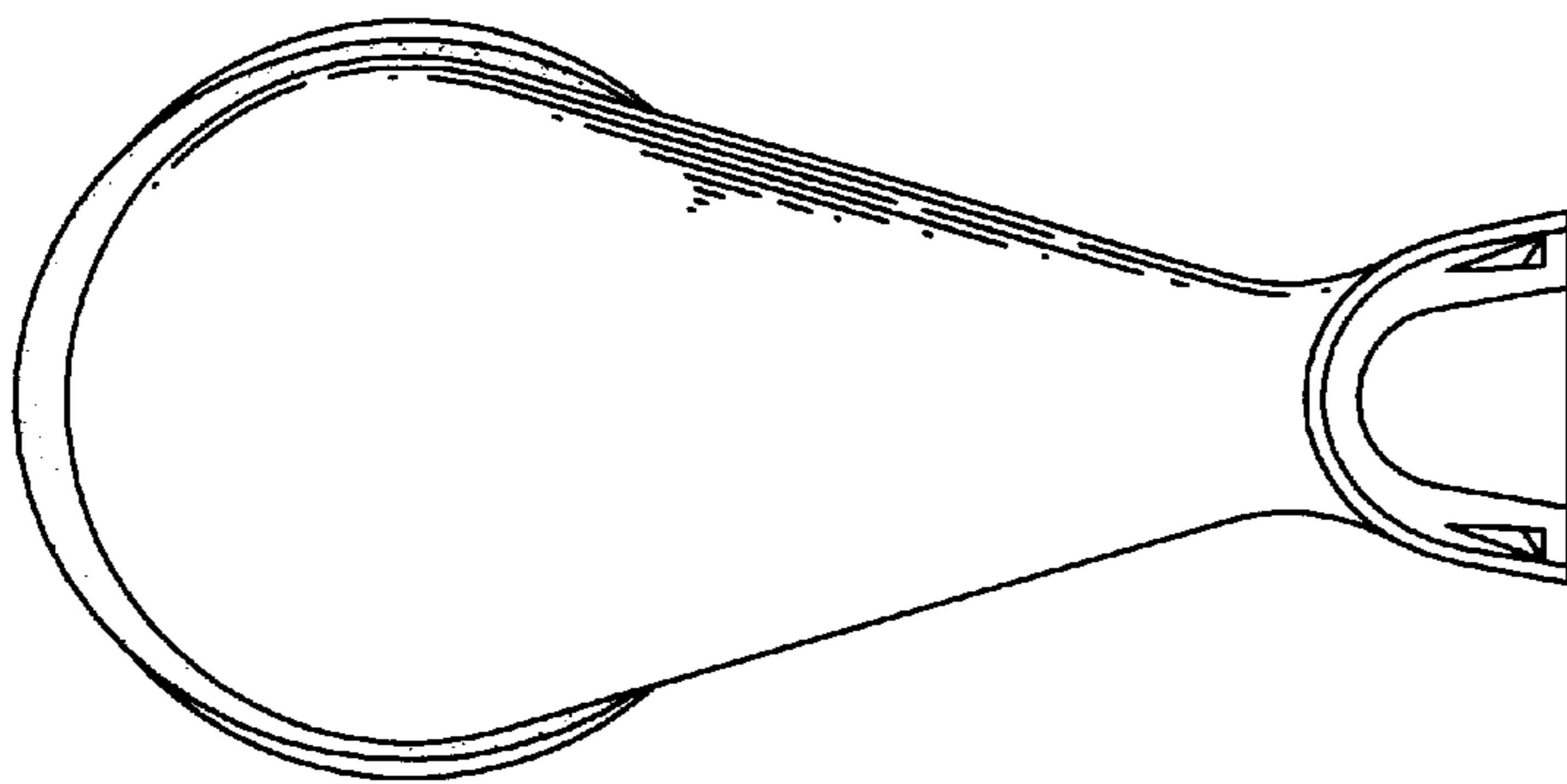

FIG. 4

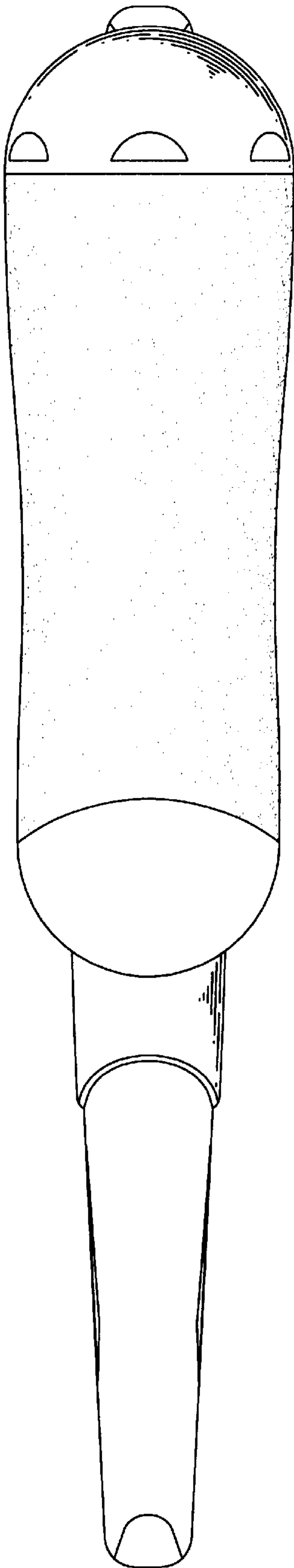

FIG. 6

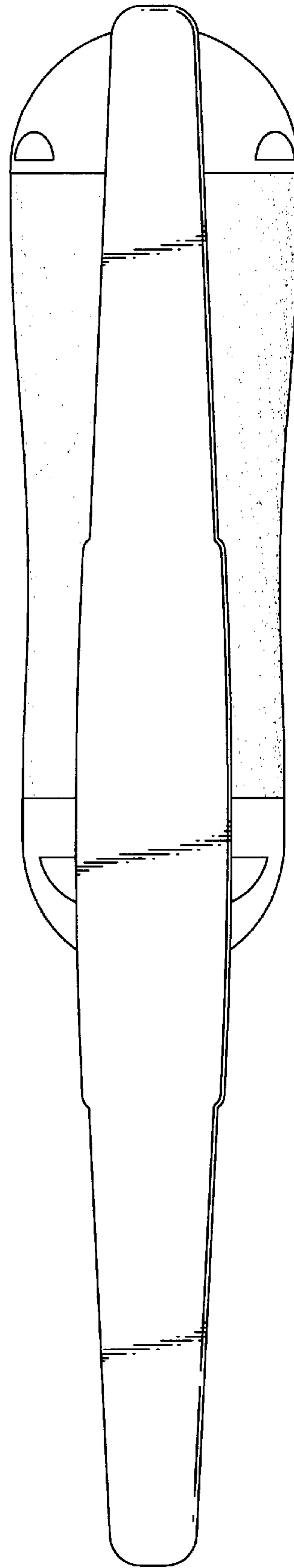

FIG. 7

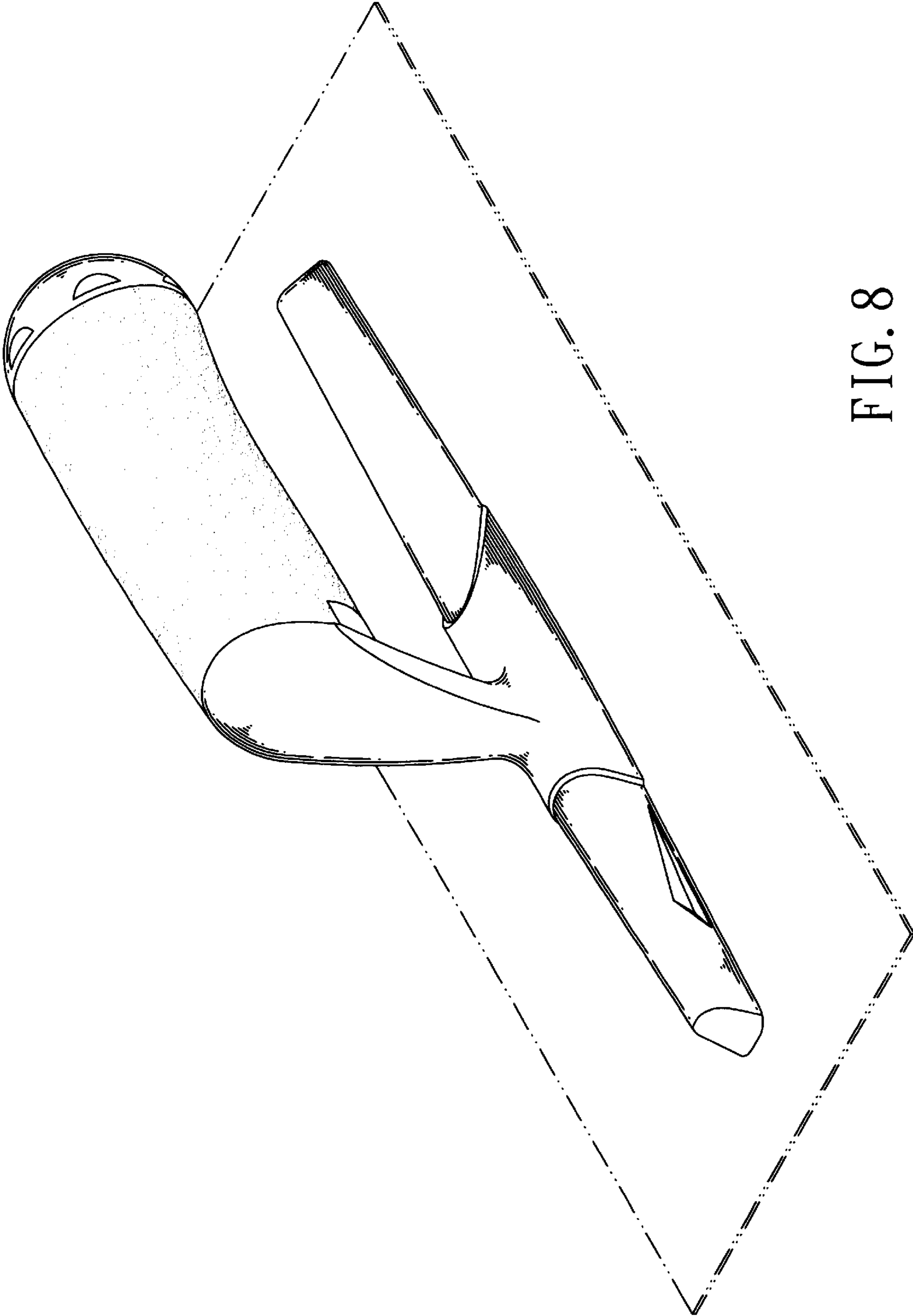

FIG. 8