



US00D538561S

(12) **United States Design Patent**
Yun

(10) **Patent No.:** **US D538,561 S**

(45) **Date of Patent:** **** Mar. 20, 2007**

(54) **CHAIR ARMREST**

(75) Inventor: **Tsai-Fu Yun**, Chang Hua Hsien (TW)

(73) Assignee: **Wonderful Year Co., Ltd.**, Apia (WS)

(**) Term: **14 Years**

(21) Appl. No.: **29/239,843**

(22) Filed: **Oct. 5, 2005**

(51) **LOC (8) Cl.** **06-06**

(52) **U.S. Cl.** **D6/501; D6/366**

(58) **Field of Classification Search** D6/334-336,
D6/364, 365, 366, 367, 379, 491, 500-502;
297/411.2, 411.27, 411.28, 411.36, 411.37,
297/463.1

See application file for complete search history.

(56) **References Cited**

U.S. PATENT DOCUMENTS

D345,866 S	*	4/1994	Barker	D6/366
D379,567 S	*	6/1997	Grivet	D6/500
D394,961 S	*	6/1998	Fancelli	D6/366
D395,175 S	*	6/1998	Fancelli	D6/372
D417,792 S	*	12/1999	Hansen et al.	D6/366
D429,422 S	*	8/2000	De Lucchi et al.	D6/366

D431,402 S	*	10/2000	Wang	D6/501
D449,173 S	*	10/2001	Chang	D6/366
D462,209 S	*	9/2002	Wu	D6/501
D472,065 S	*	3/2003	Tseng	D6/366
D474,040 S	*	5/2003	Meda	D6/366
2003/0160492 A1	*	8/2003	Tsai	297/411.2

* cited by examiner

Primary Examiner—Mimosa De

(74) *Attorney, Agent, or Firm*—Alan D. Kamrath; Nikolai & Mersereau, P.A.

(57) **CLAIM**

The ornamental design for chair armrest, as shown and described.

DESCRIPTION

FIG. 1 is a perspective view of a chair armrest showing my new design;

FIG. 2 is a front view thereof;

FIG. 3 is a rear view thereof;

FIG. 4 is a left view thereof;

FIG. 5 is a right view thereof;

FIG. 6 is a top view thereof; and,

FIG. 7 is a bottom view thereof.

1 Claim, 2 Drawing Sheets

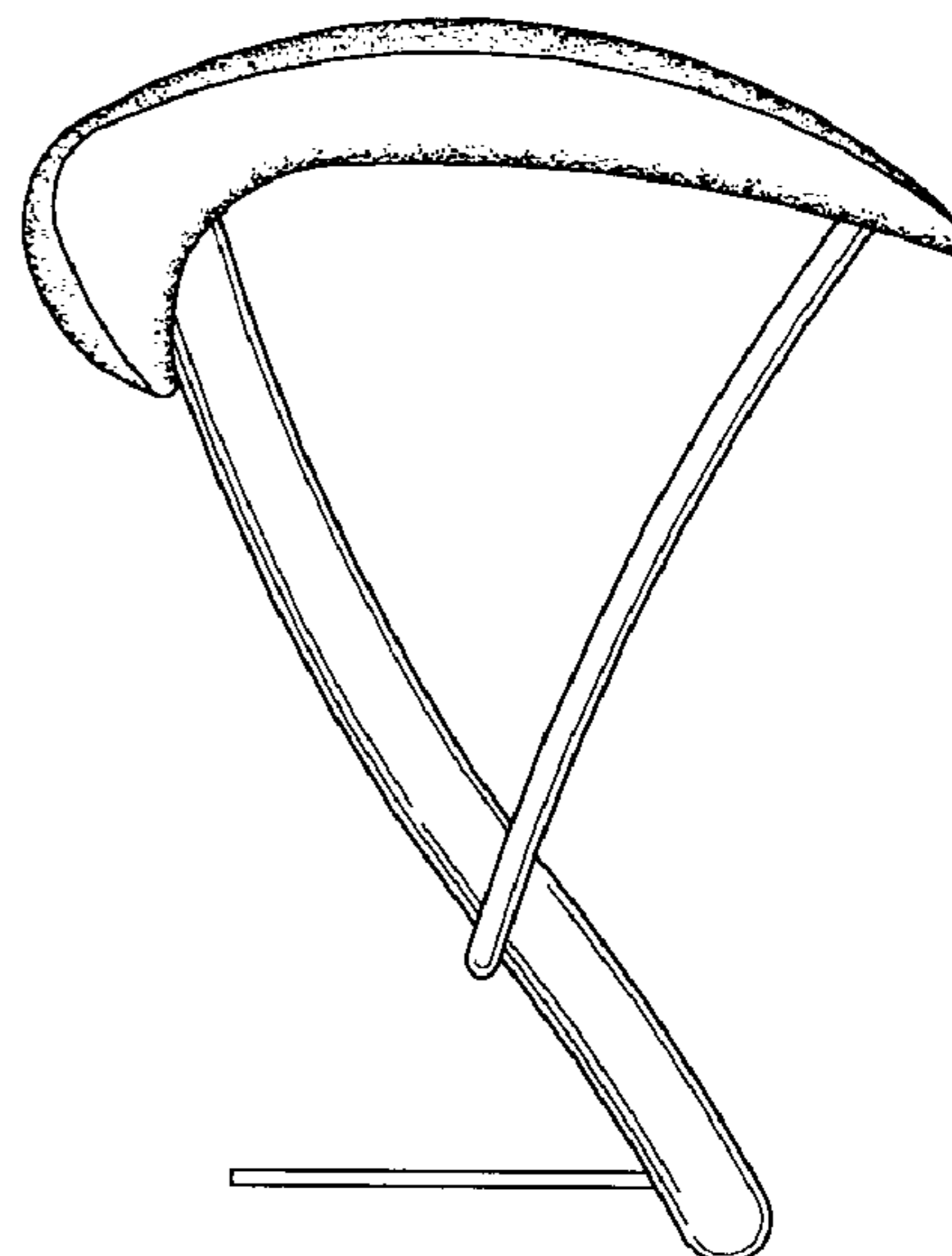
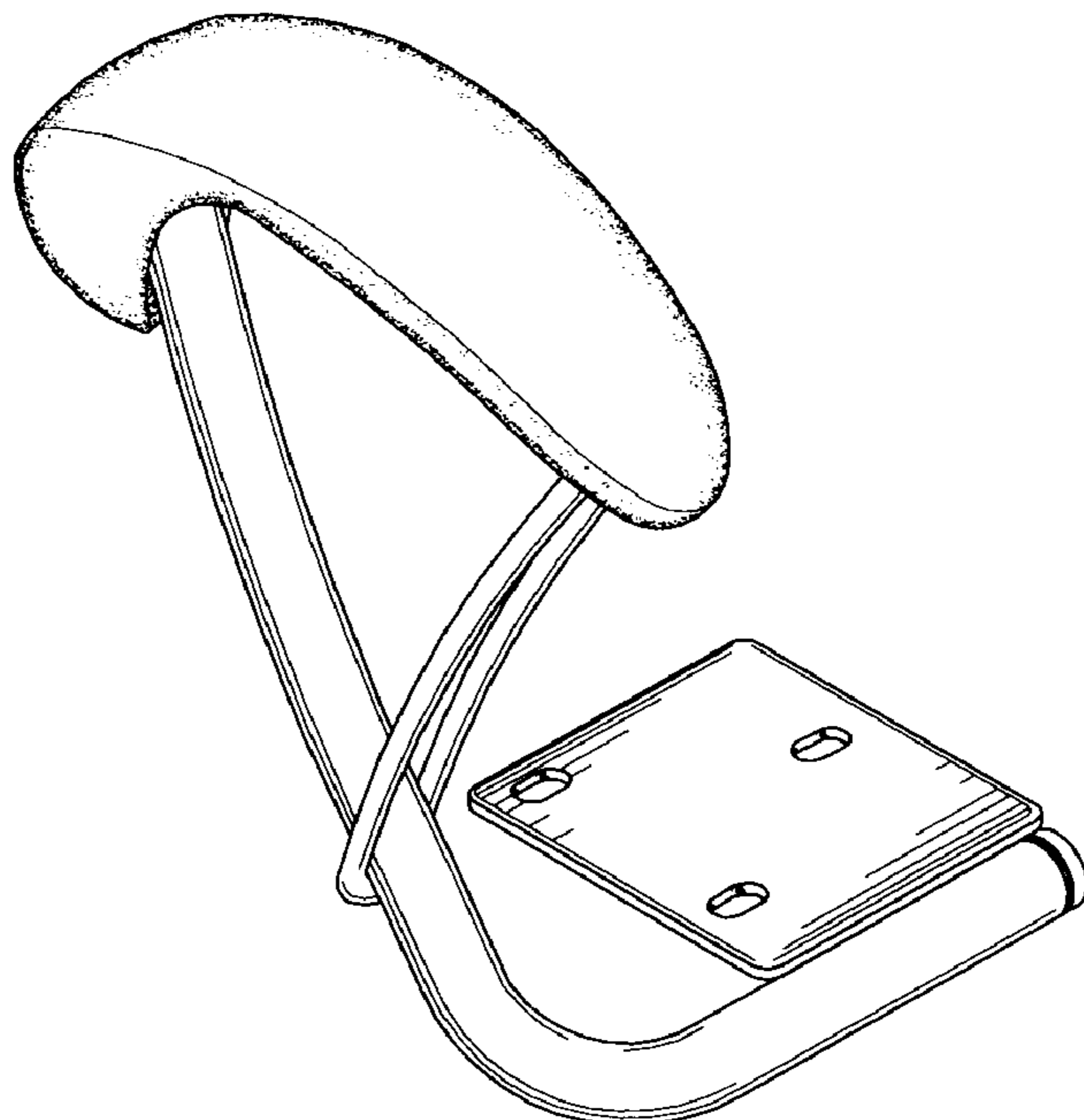

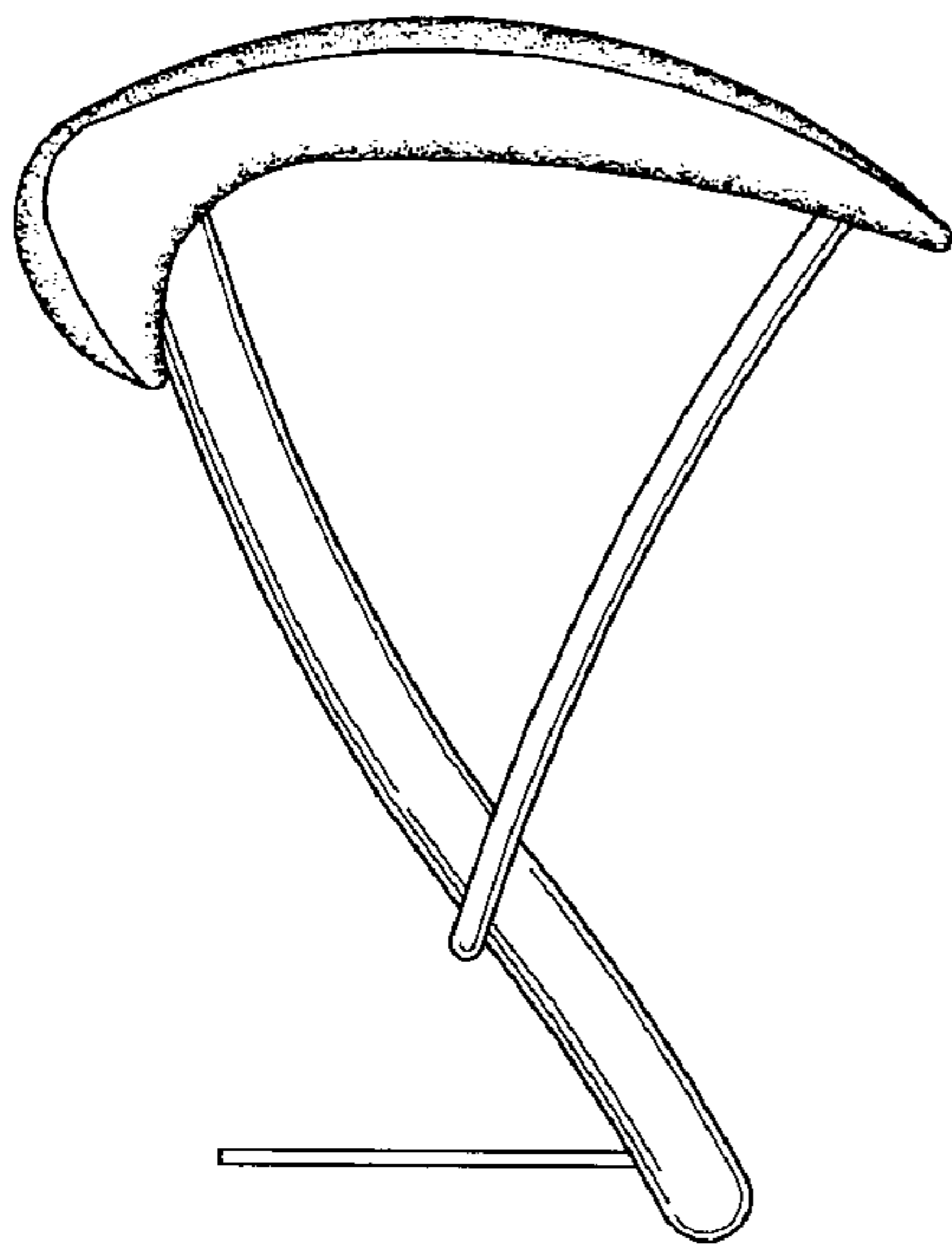
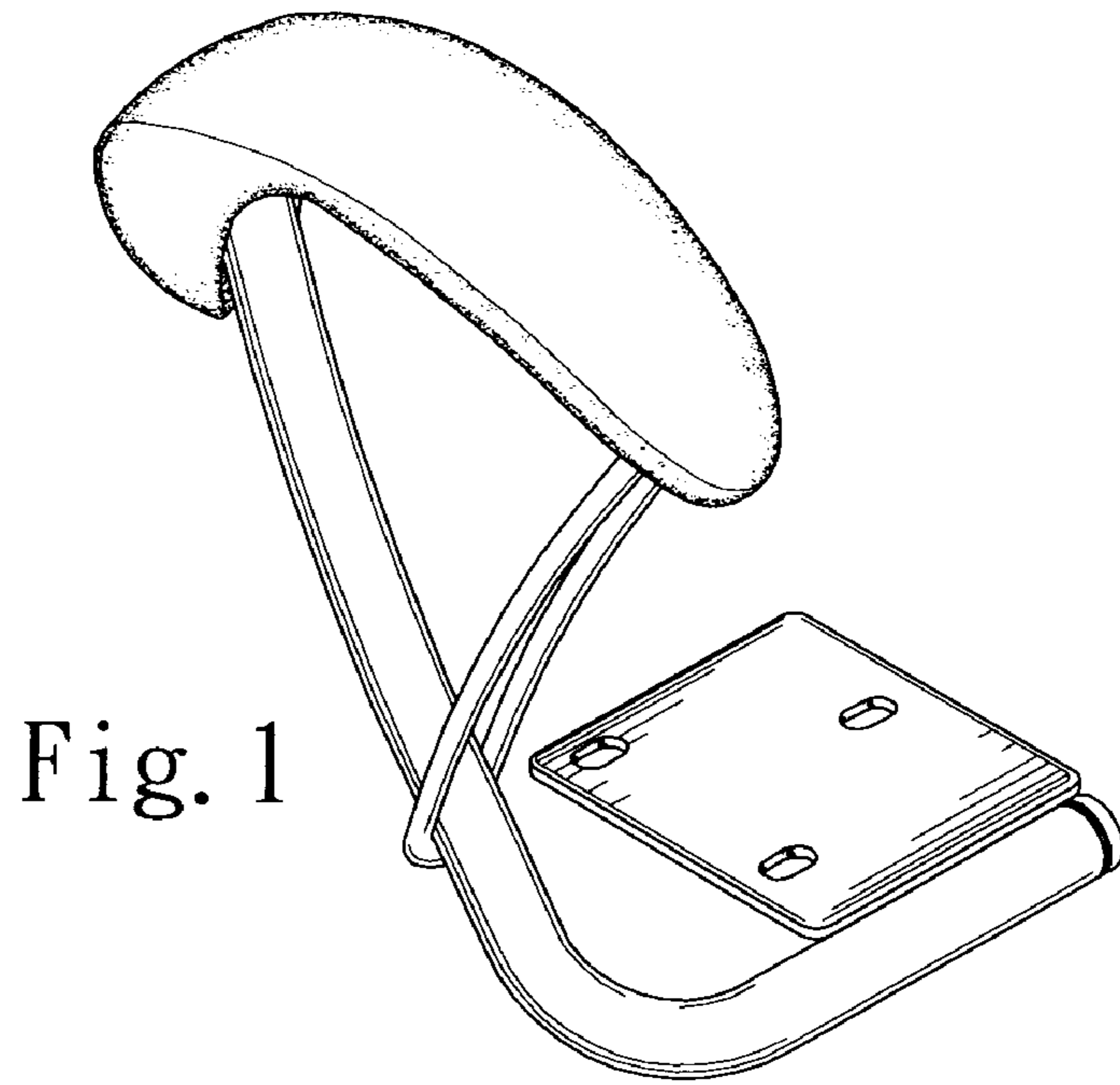

Fig. 2

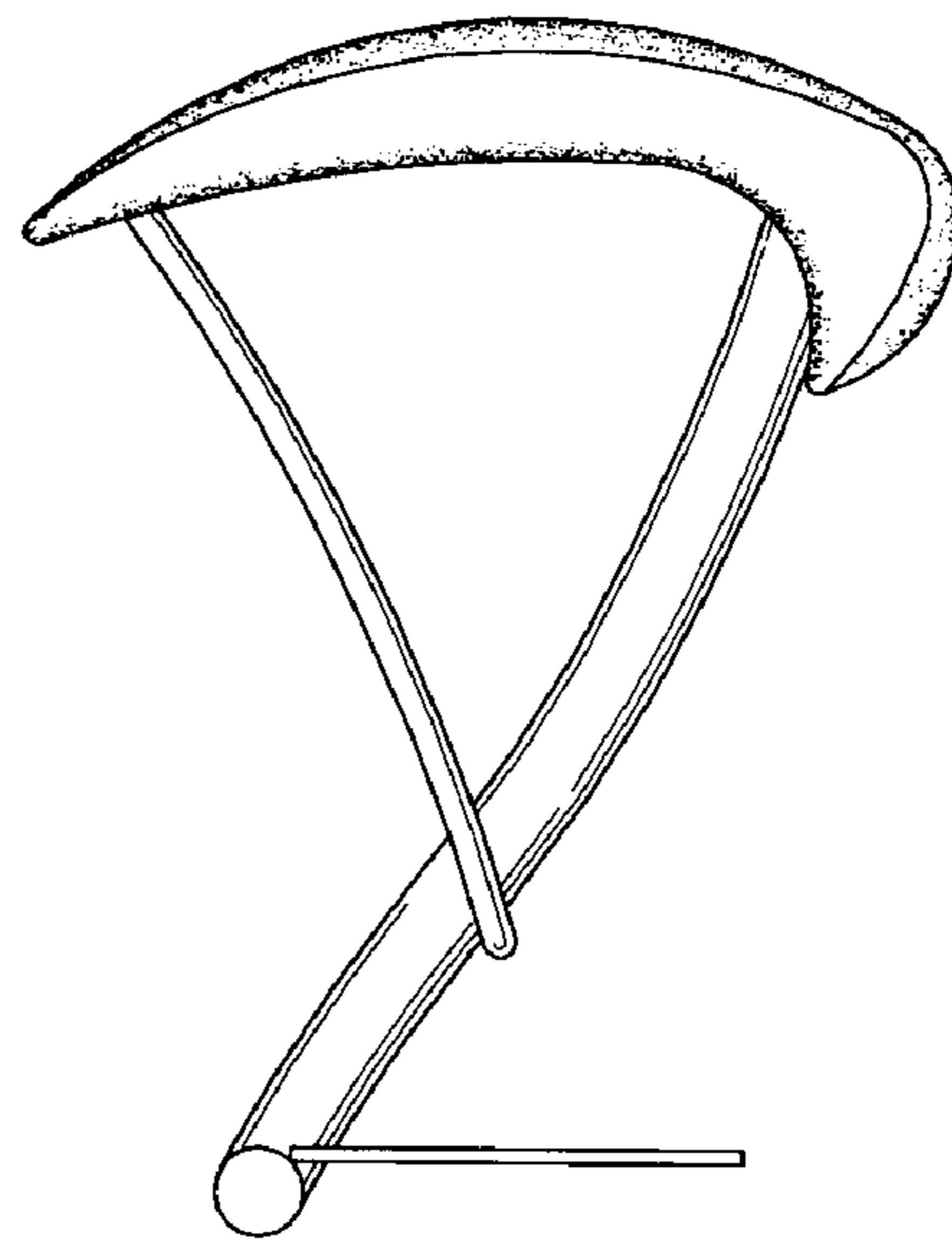

Fig. 3

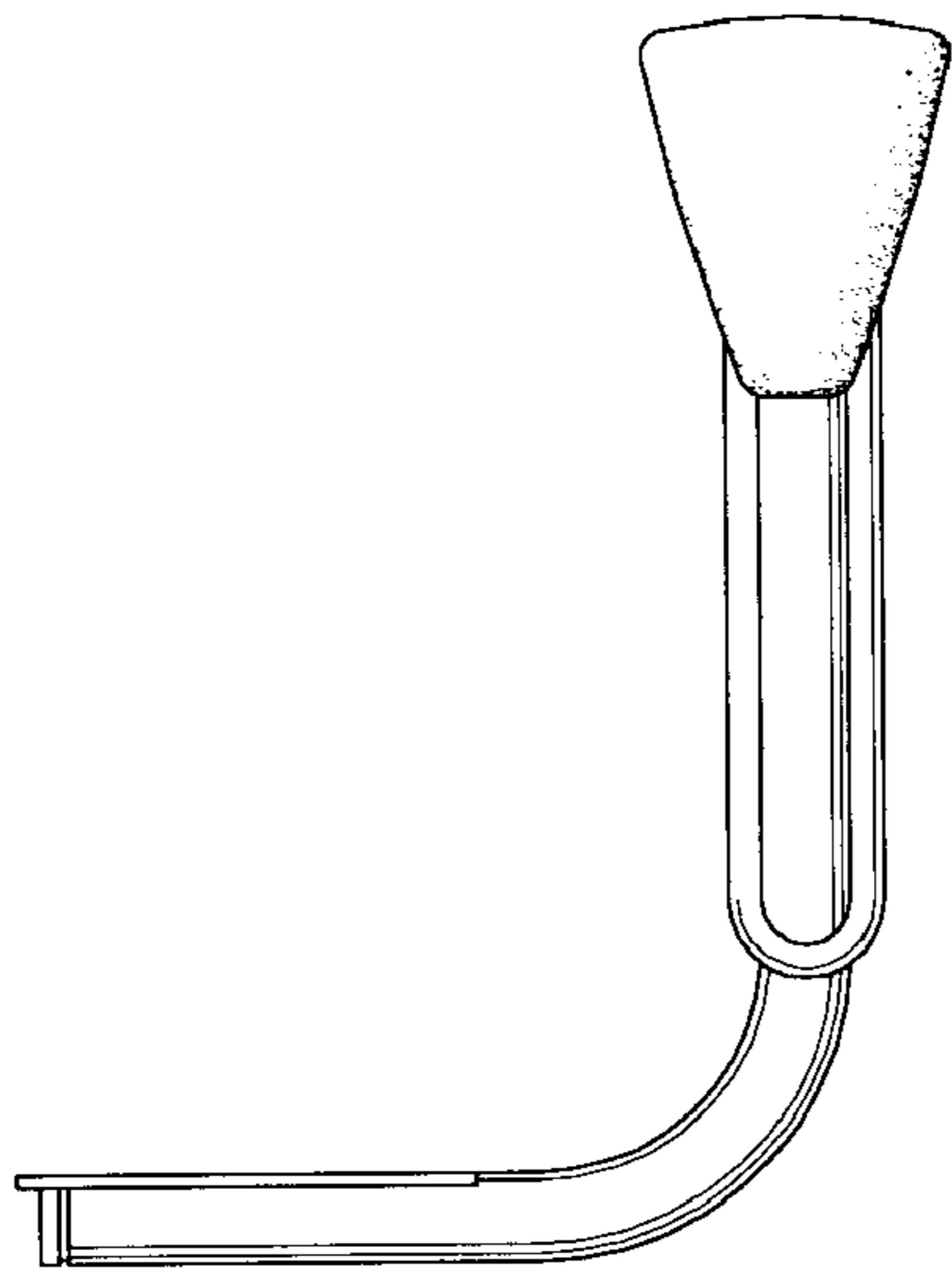

Fig. 4

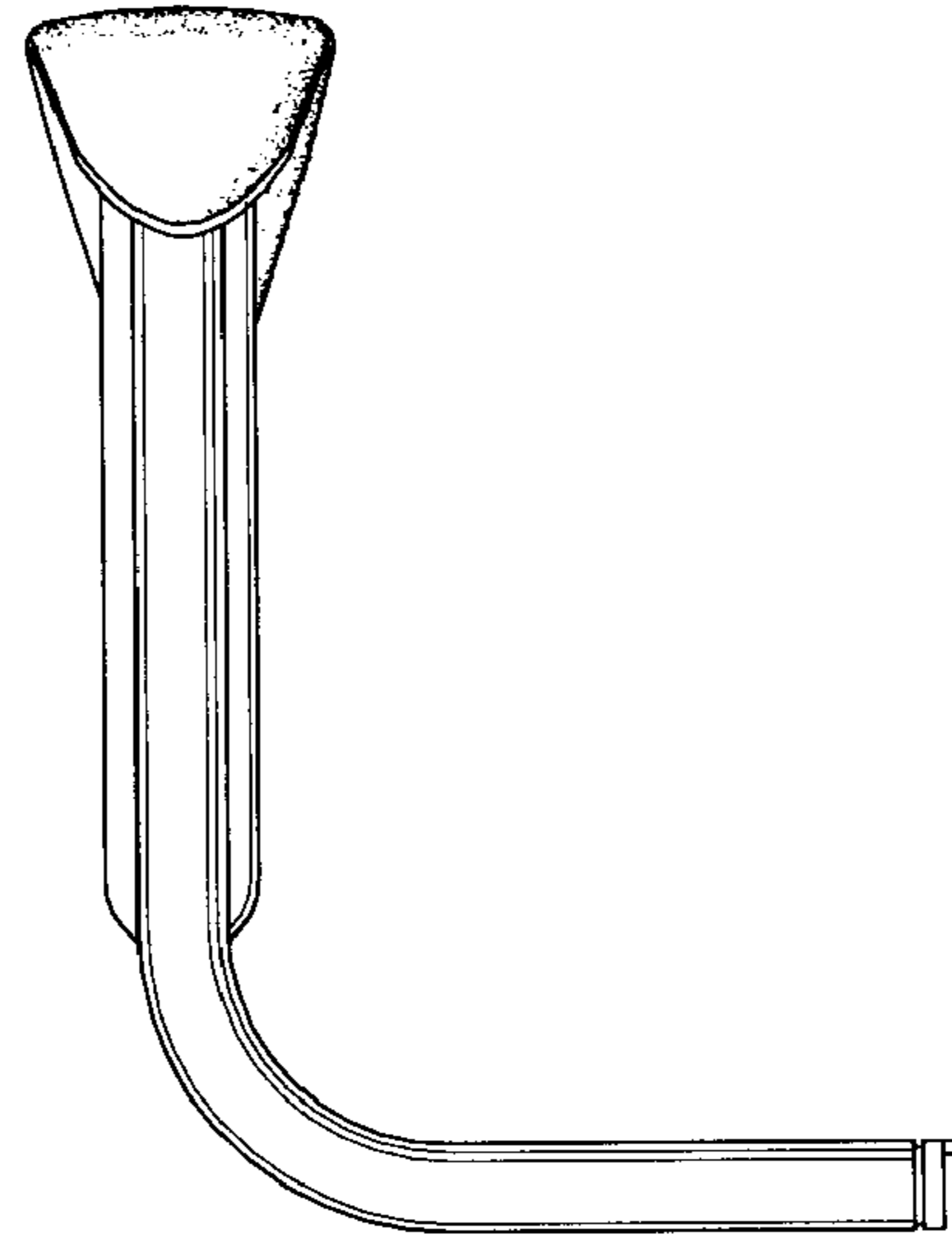

Fig. 5

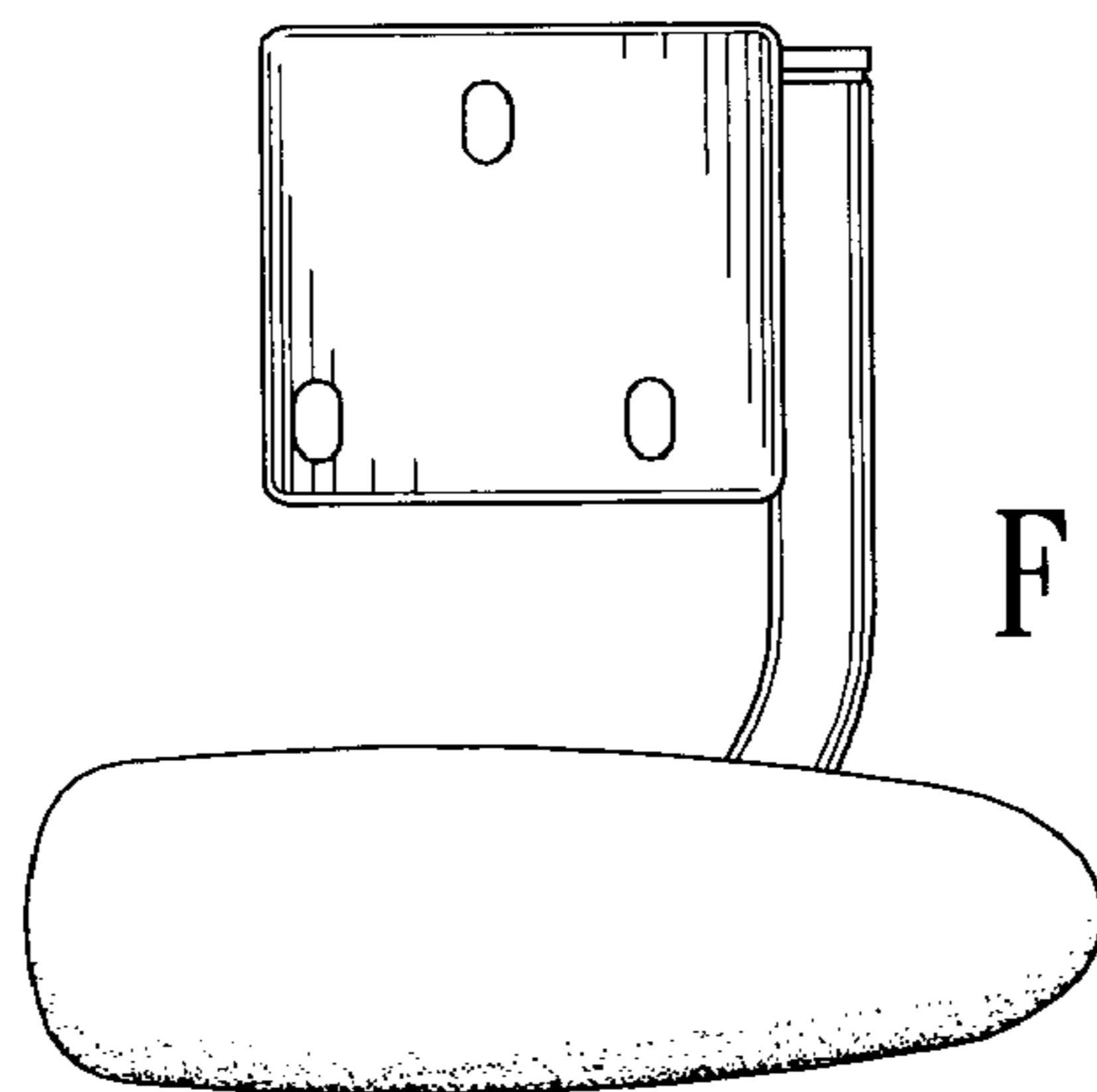

Fig. 6

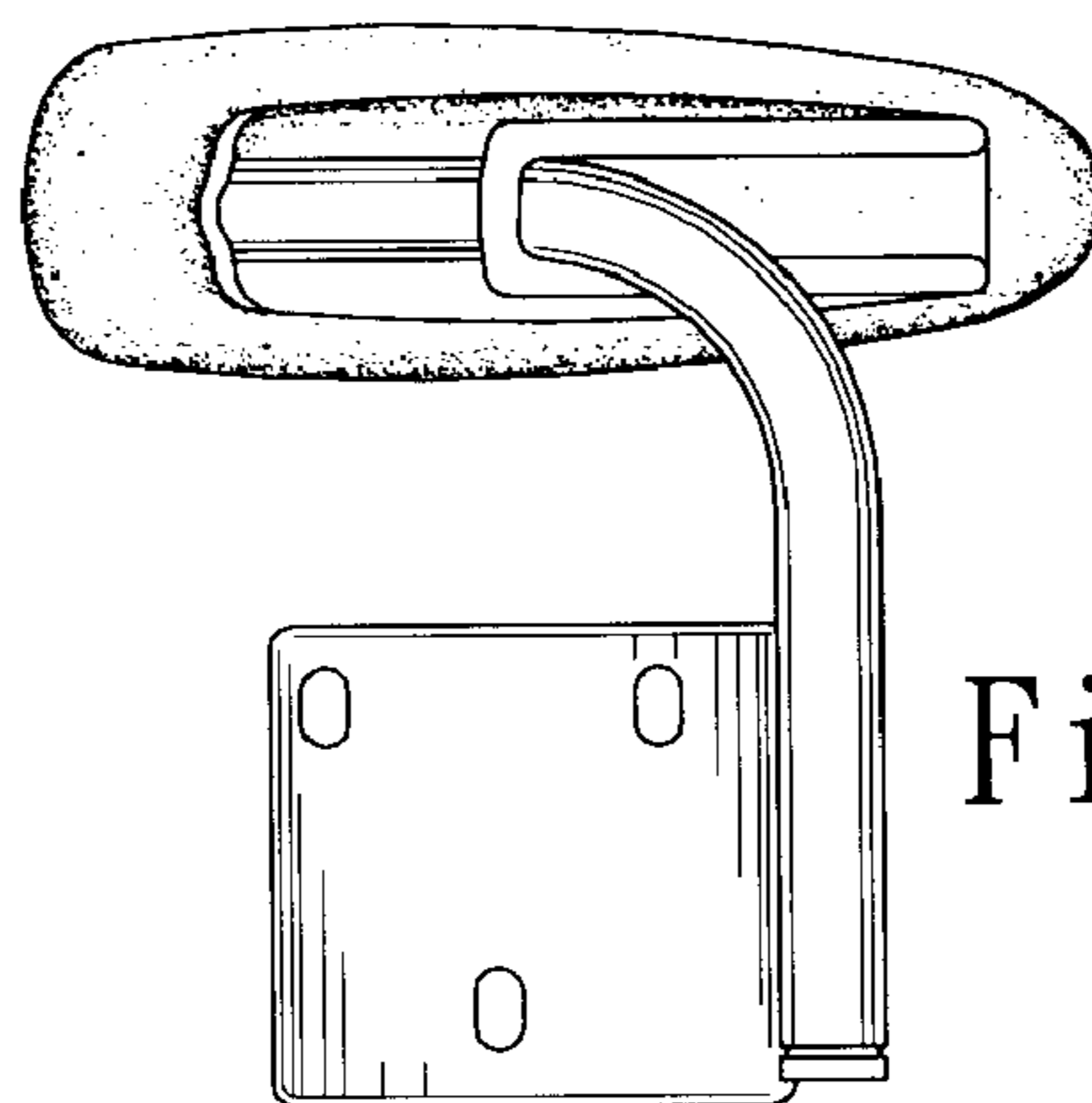

Fig. 7