



US00D538505S

(12) **United States Design Patent**
Kang et al.

(10) **Patent No.:** **US D538,505 S**

(45) **Date of Patent:** **** Mar. 13, 2007**

(54) **AUTOMATED TELLER MACHINE**

(75) Inventors: **Dong Goo Kang**, Kyungi-Do (KR);
Dong Chan Lee, Kyungi-Do (KR);
Joon Hae Kim, Kyungi-Do (KR)

(73) Assignee: **Nautilus Hyosung Inc.** (KR)

(**) Term: **14 Years**

(21) Appl. No.: **29/246,009**

(22) Filed: **Dec. 15, 2005**

(51) **LOC (8) Cl.** **99-00**

(52) **U.S. Cl.** **D99/28**

(58) **Field of Classification Search** D99/28,
D99/43, 99; D20/1, 4, 5; D18/3.1, 3.3, 4.6;
D6/421, 436, 470; D14/130, 302, 308; 235/379,
235/380, 381; 221/128-130; 453/1-6, 21,
453/58; 194/206, 217, 347, 350; 361/681;
25/1

See application file for complete search history.

(56) **References Cited**

U.S. PATENT DOCUMENTS

- D318,553 S * 7/1991 Brown D99/28
- 5,553,320 A * 9/1996 Matsuura et al. 235/379
- D388,229 S * 12/1997 Couch D99/28
- D405,833 S * 2/1999 Mussett D20/1
- 5,984,177 A * 11/1999 Do et al. 235/379
- D419,277 S * 1/2000 Ishii et al. D99/35

- D437,468 S * 2/2001 Fukutake et al. D99/28
- D447,164 S * 8/2001 Forslund D18/3.1
- D456,587 S * 4/2002 Kit et al. D99/28
- 6,527,172 B1 * 3/2003 Lewis et al. 235/379
- D481,516 S * 10/2003 Magee et al. D99/28
- D492,081 S * 6/2004 Magee et al. D99/28
- D492,082 S * 6/2004 Magee et al. D99/28

* cited by examiner

Primary Examiner—Paula A. Greene

(74) *Attorney, Agent, or Firm*—Fish & Richardson P.C.

(57) **CLAIM**

The ornamental design for an automated teller machine, as shown and described.

DESCRIPTION

The combined shape and figure of the automated teller machine is claimed as the main point of creation in the design application.

FIG. 1 is a perspective view.

FIG. 2 is a front view.

FIG. 3 is a rear view.

FIG. 4 is a left side view.

FIG. 5 is a right side view.

FIG. 6 is a plan view.

FIG. 7 is a bottom view; and,

FIG. 8 is a perspective view in an open position thereof, the undisclosed portions are not part of the claimed design.

1 Claim, 7 Drawing Sheets

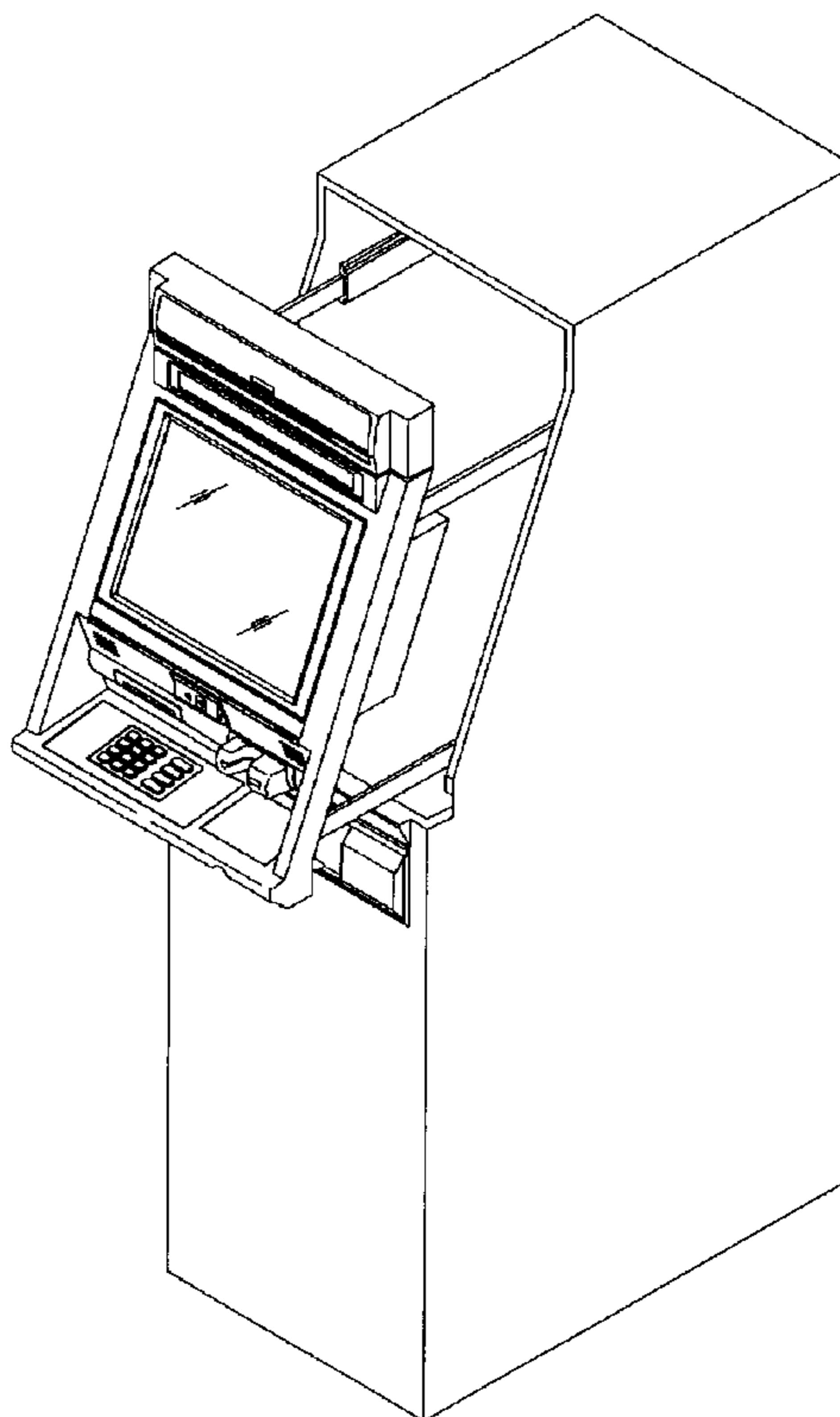

FIGURE 1

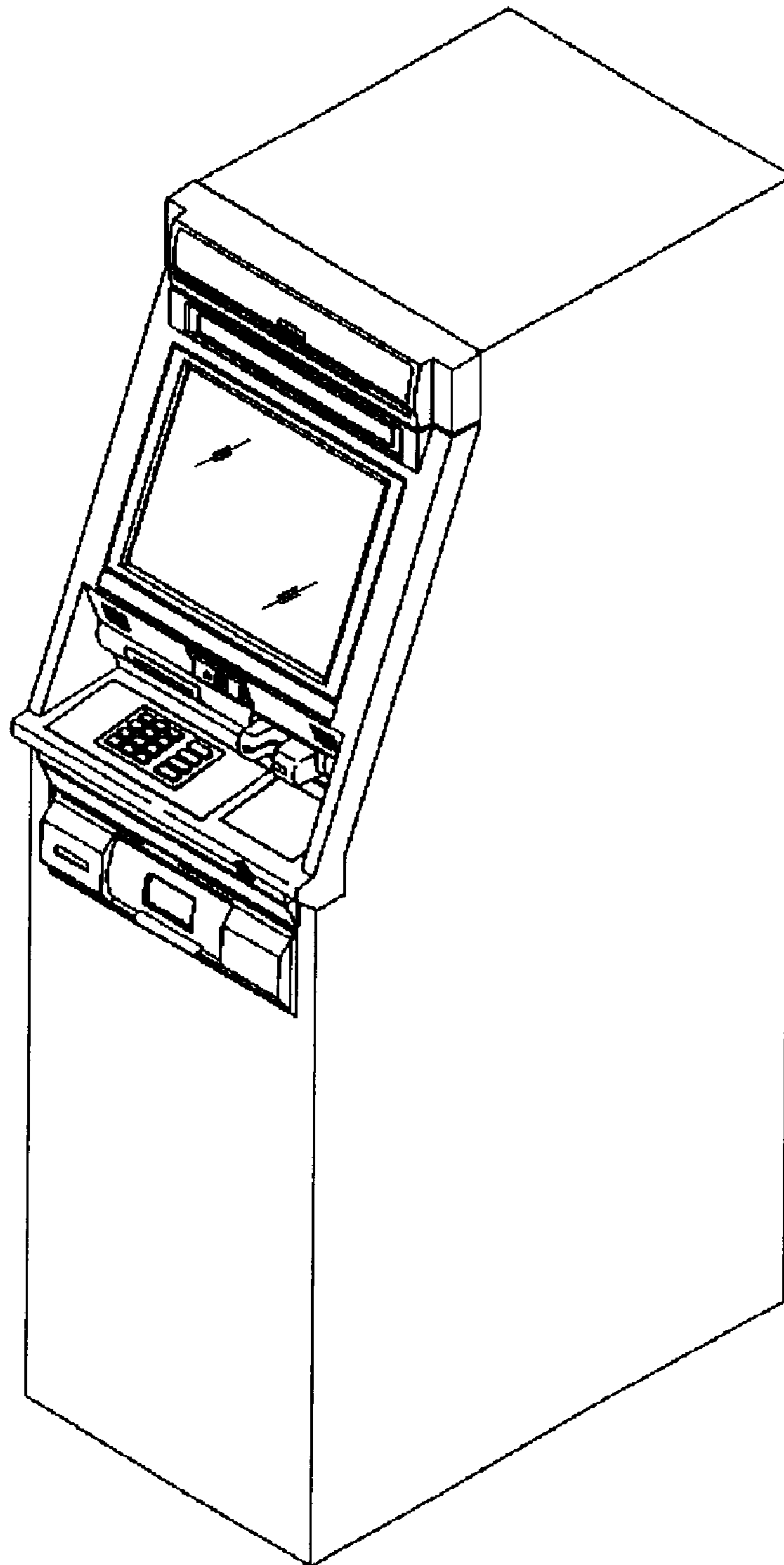

FIGURE 2

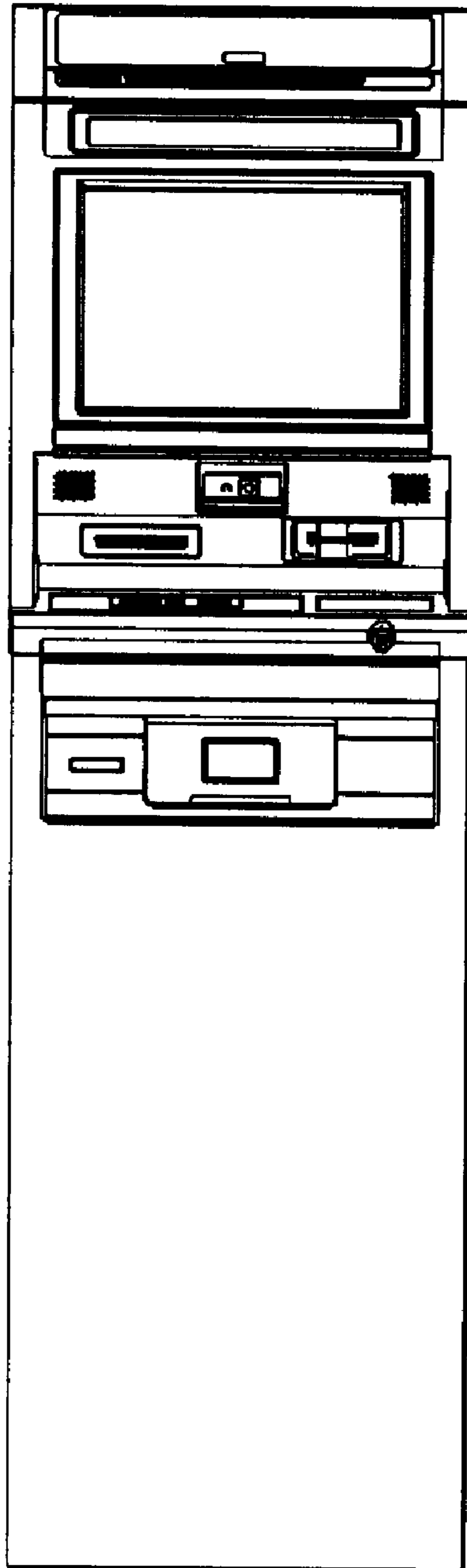

FIGURE 3

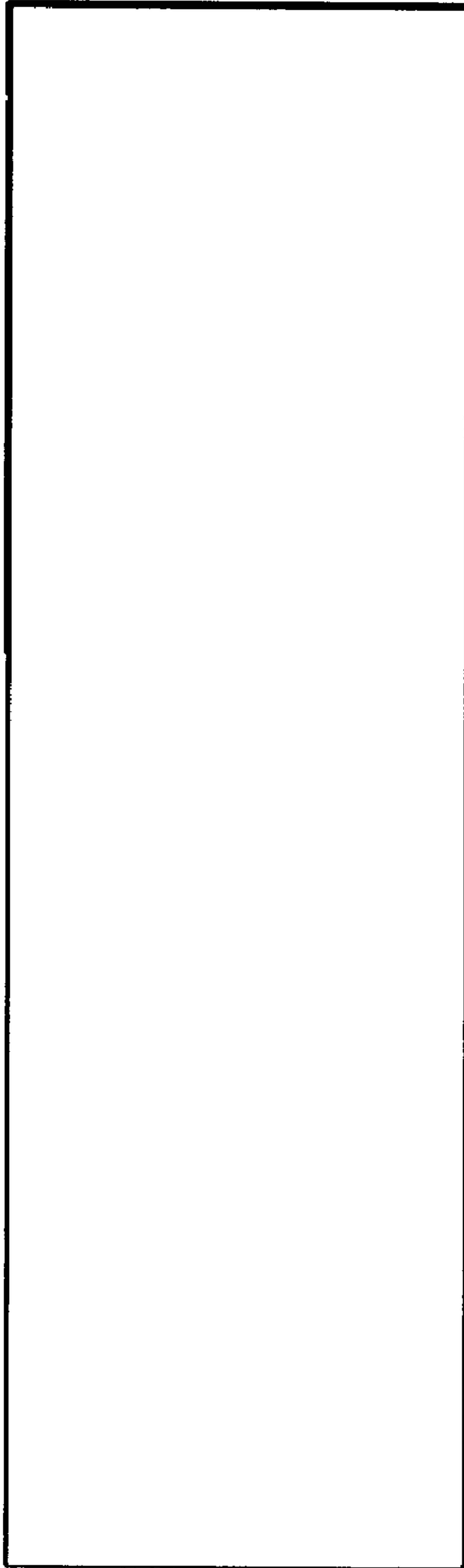

FIGURE 4

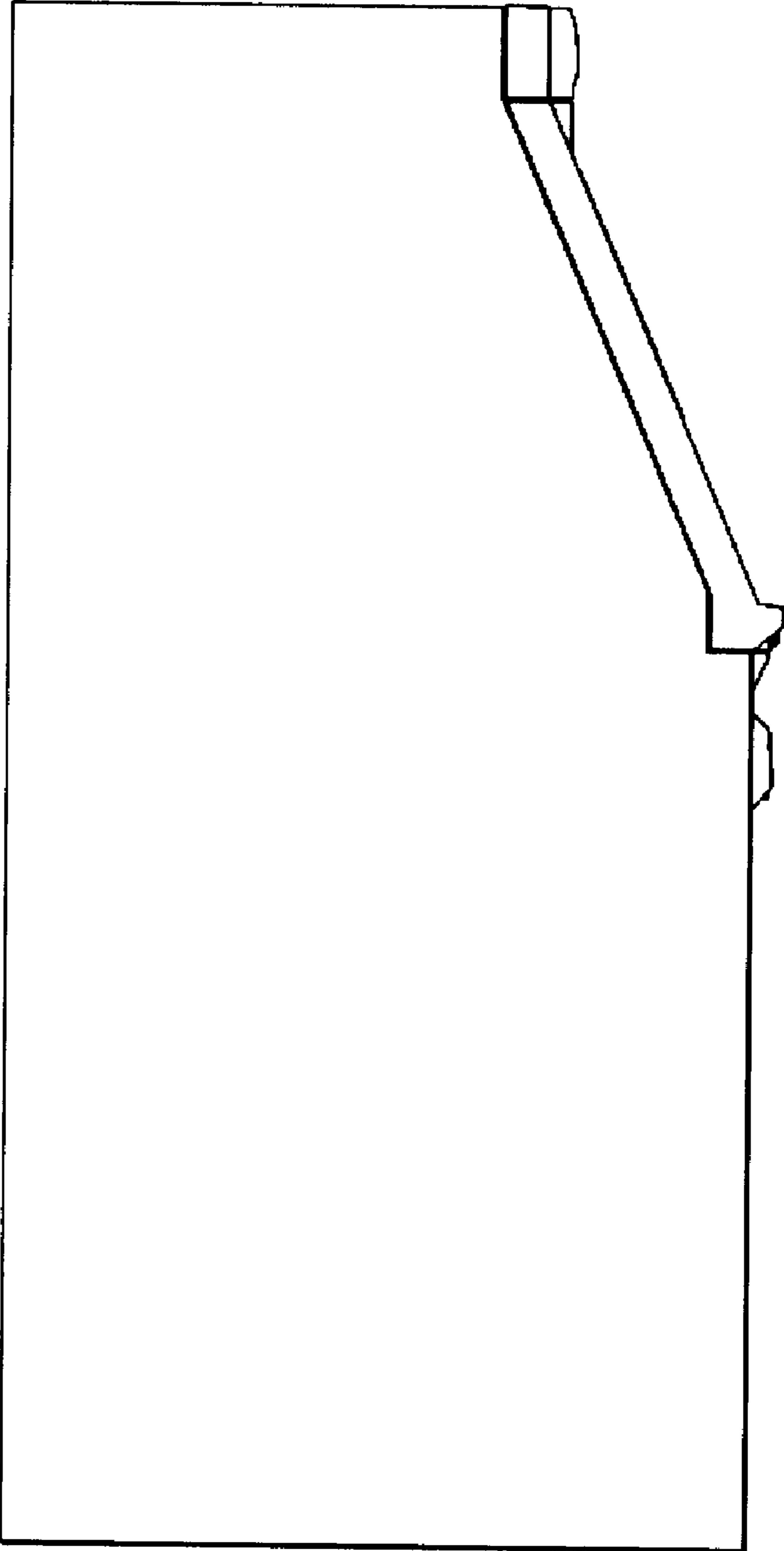

FIGURE 5

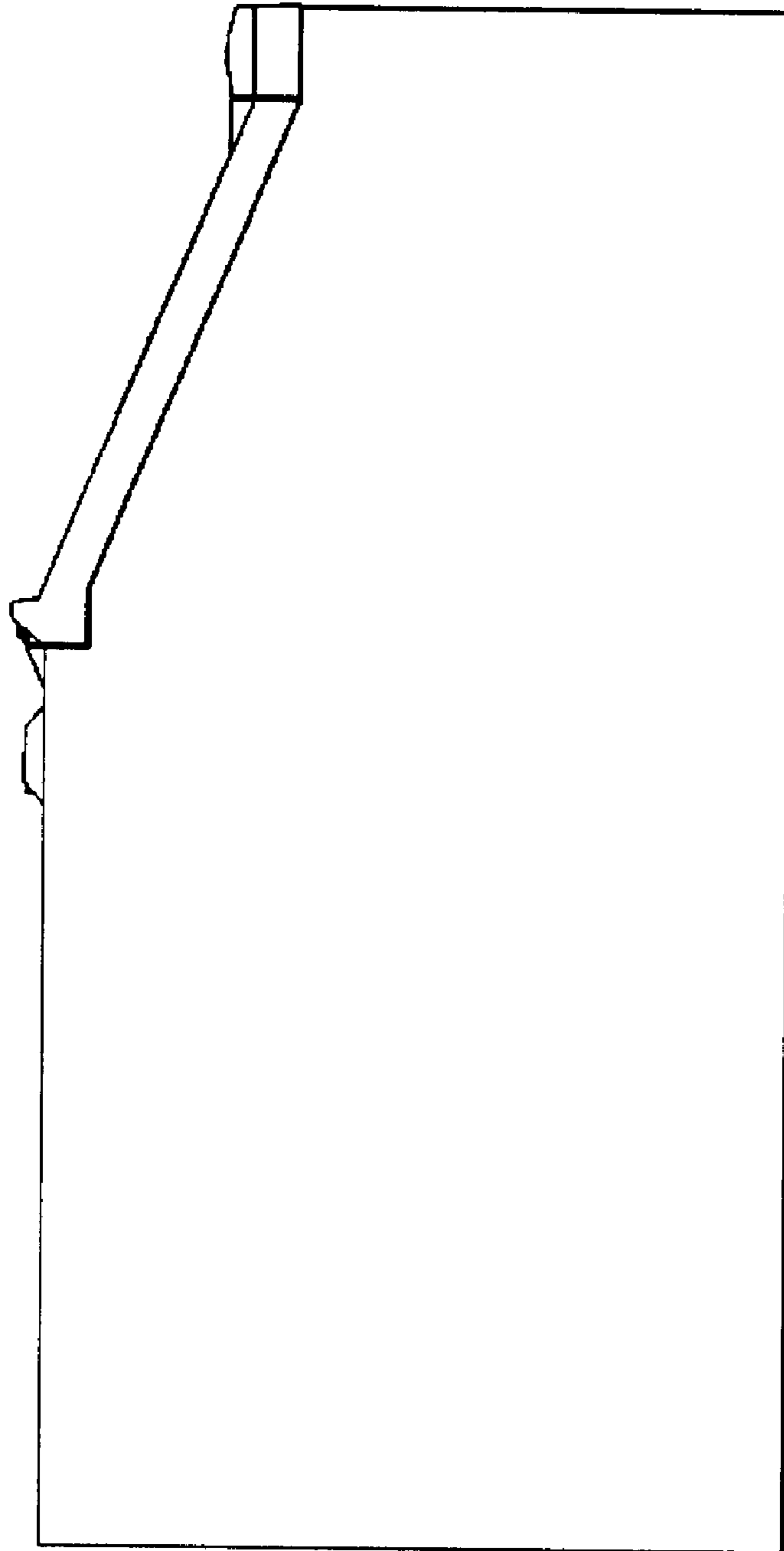

FIGURE 6

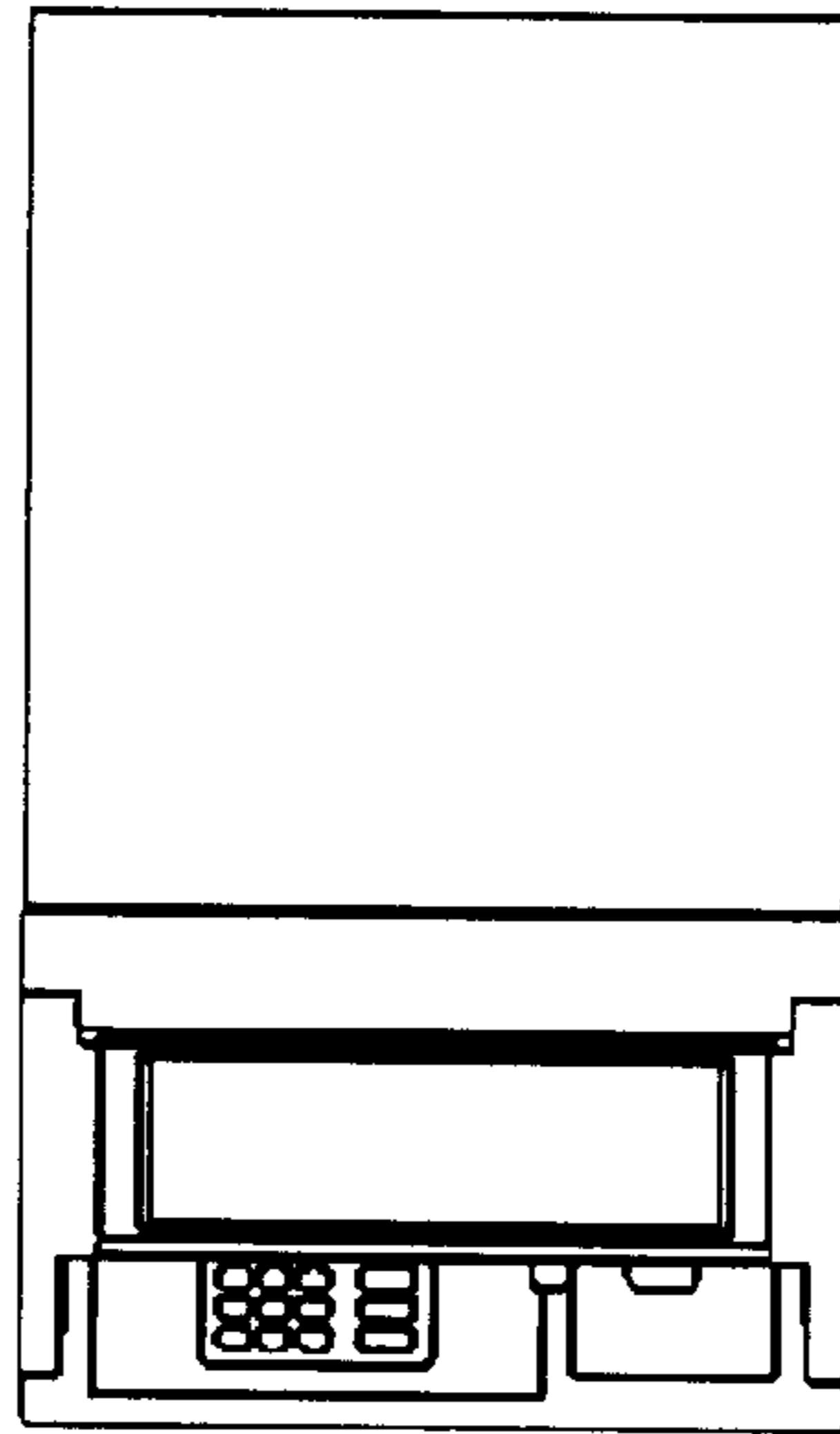

FIGURE 7

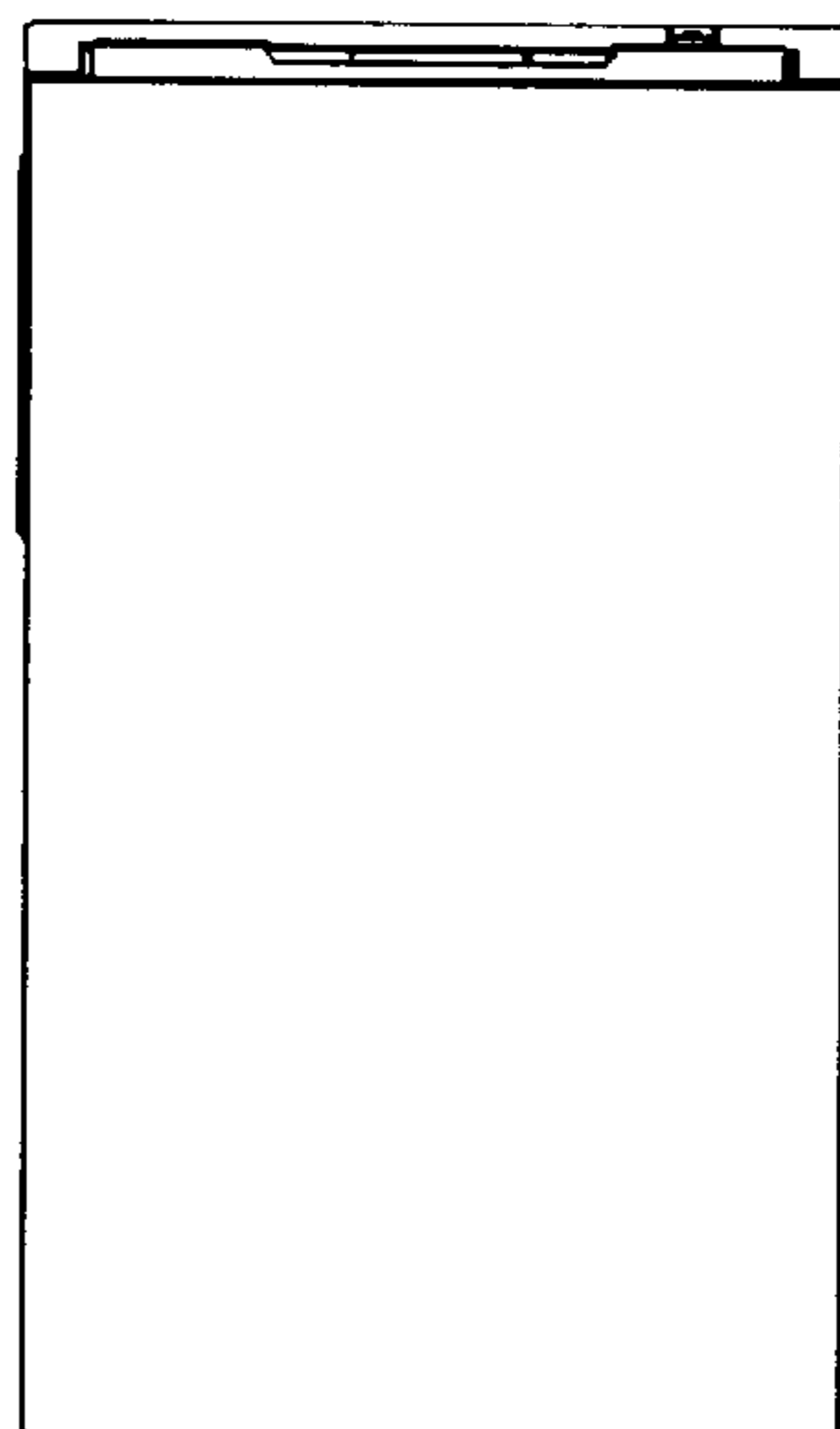

FIGURE 8

