

US00D538269S

(12) **United States Design Patent**
Tragatschnig

(10) **Patent No.:** **US D538,269 S**

(45) **Date of Patent:** **** Mar. 13, 2007**

(54) **FOLDABLE HEADSET**

(75) Inventor: **Joerg Tragatschnig**, Zell am See (AT)

(73) Assignee: **Eton Corporation**, Palo Alto, CA (US)

(**) Term: **14 Years**

(21) Appl. No.: **29/251,273**

(22) Filed: **Jan. 4, 2006**

(51) **LOC (8) Cl.** **14-01**

(52) **U.S. Cl.** **D14/223**

(58) **Field of Classification Search** D14/205,
D14/206, 223, 192, 188; 381/380, 381; 379/430-431;
D29/112; 2/209; 181/129

See application file for complete search history.

(56) **References Cited**

U.S. PATENT DOCUMENTS

D311,609 S	*	10/1990	Stoneburner, Sr.	D29/112
D331,059 S	*	11/1992	Sogabe et al.	D14/205
D347,845 S	*	6/1994	Sumikawa	D14/205
5,459,290 A	*	10/1995	Yamagishi	181/129
D373,360 S	*	9/1996	Kanno	D14/205
D399,206 S	*	10/1998	Yasutomi et al.	D14/205
D404,035 S	*	1/1999	Delazzer	D14/206
6,104,824 A	*	8/2000	Ito	381/381
D444,140 S	*	6/2001	Ishibashi	D14/192
D463,396 S	*	9/2002	Beraut et al.	D14/205

D477,820 S	*	7/2003	Suzuki et al.	D14/205
D502,938 S	*	3/2005	Tokioka et al.	D14/205
D525,614 S	*	7/2006	Lee	D14/205

* cited by examiner

Primary Examiner—Paula A. Greene

(74) *Attorney, Agent, or Firm*—Jones Day; Brett Lovejoy

(57) **CLAIM**

The ornamental design for a foldable headset, as shown and described.

DESCRIPTION

FIG. 1 is a front perspective view of an ornamental design for a foldable headset according to the present invention in which the headset is in a first unfolded configuration;

FIG. 2 is a view of one side thereof;

FIG. 3 is a view of the other side thereof;

FIG. 4 is a bottom view thereof;

FIG. 5 is a back view thereof;

FIG. 6 is a top view thereof;

FIG. 7 is a front view thereof;

FIG. 8 is a side view of the ornamental design for the foldable headset according to the present invention in a second unfolded configuration; and,

FIG. 9 is a front perspective view of the ornamental design for the foldable headset according to the present invention in which the headset is in a folded configuration.

1 Claim, 5 Drawing Sheets

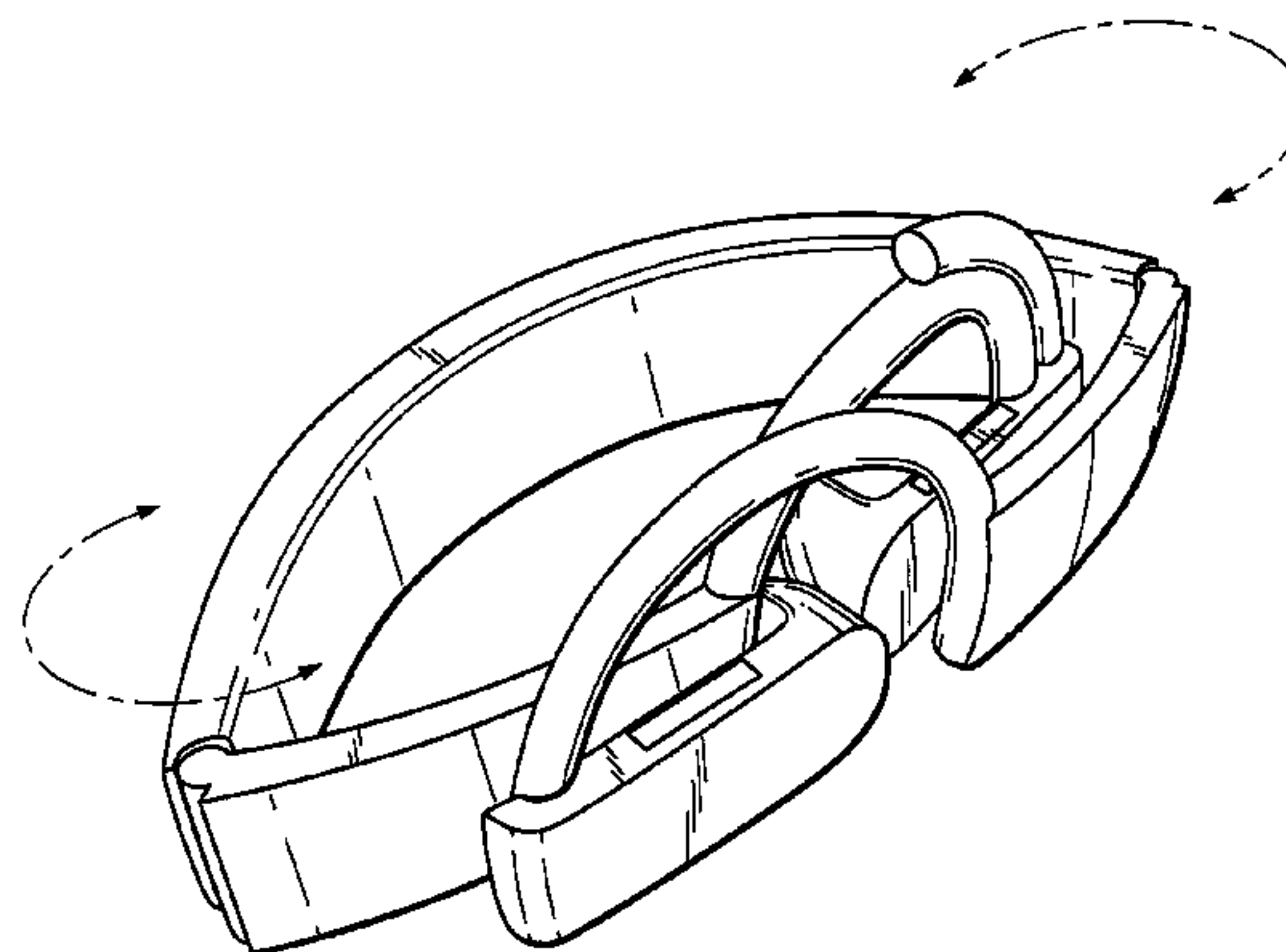
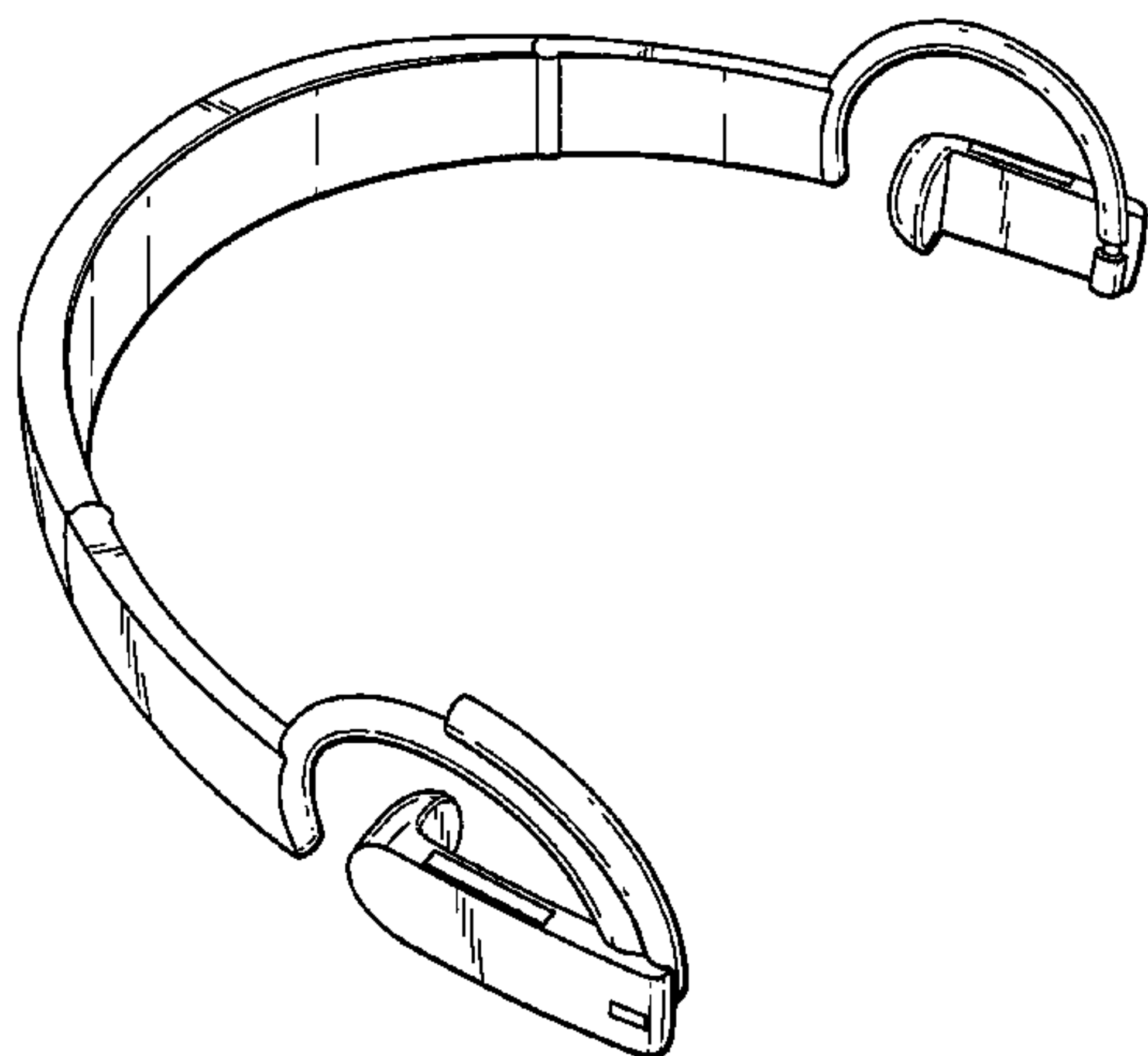

FIG. 1

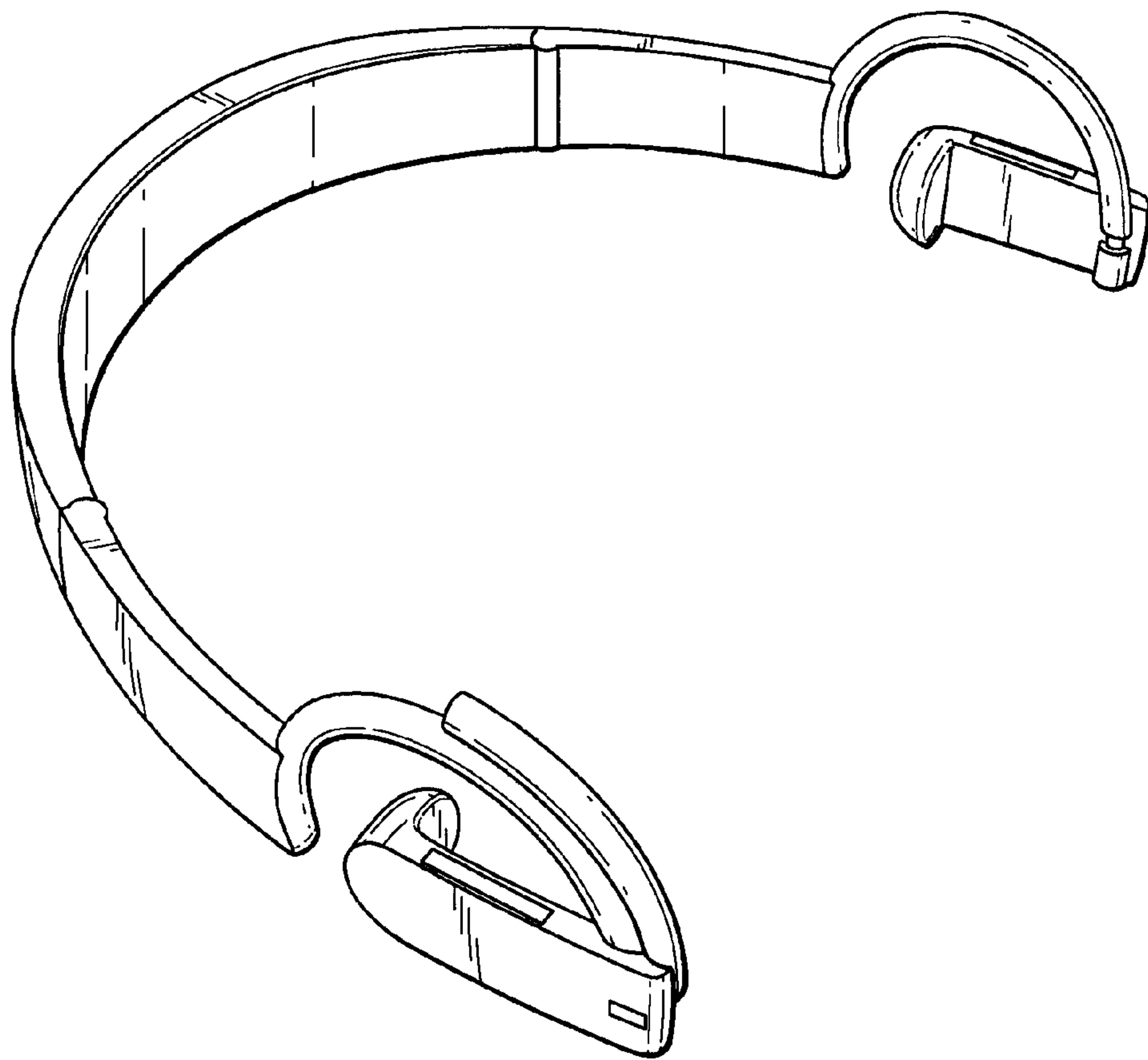

FIG. 2



FIG. 3

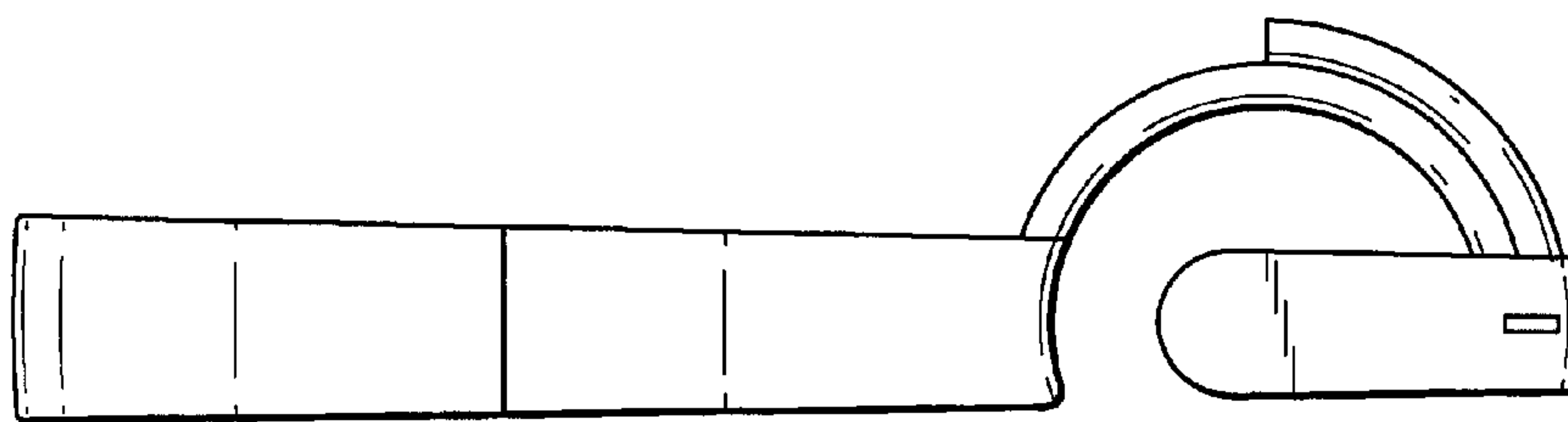

FIG. 4

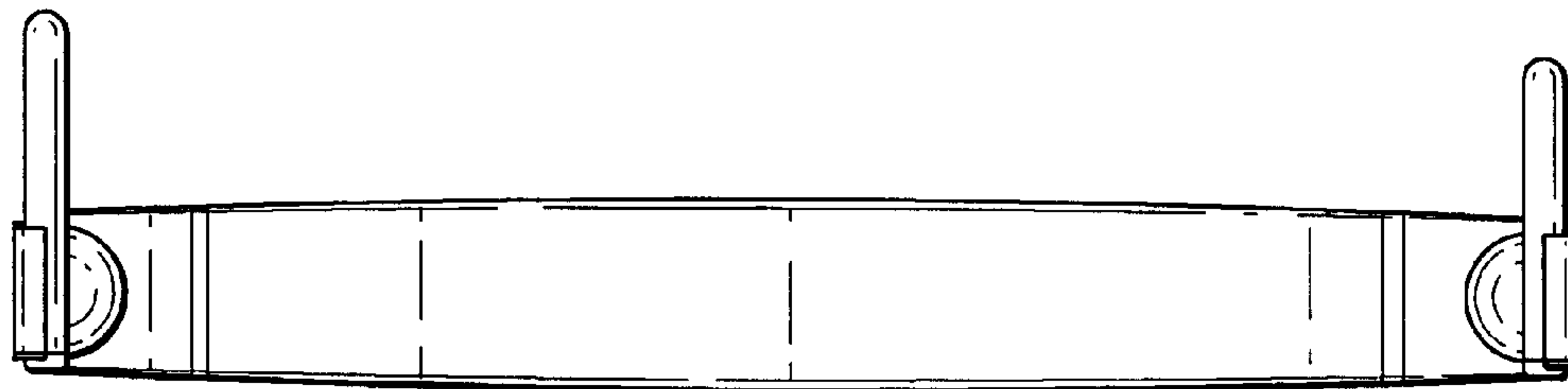

FIG. 5

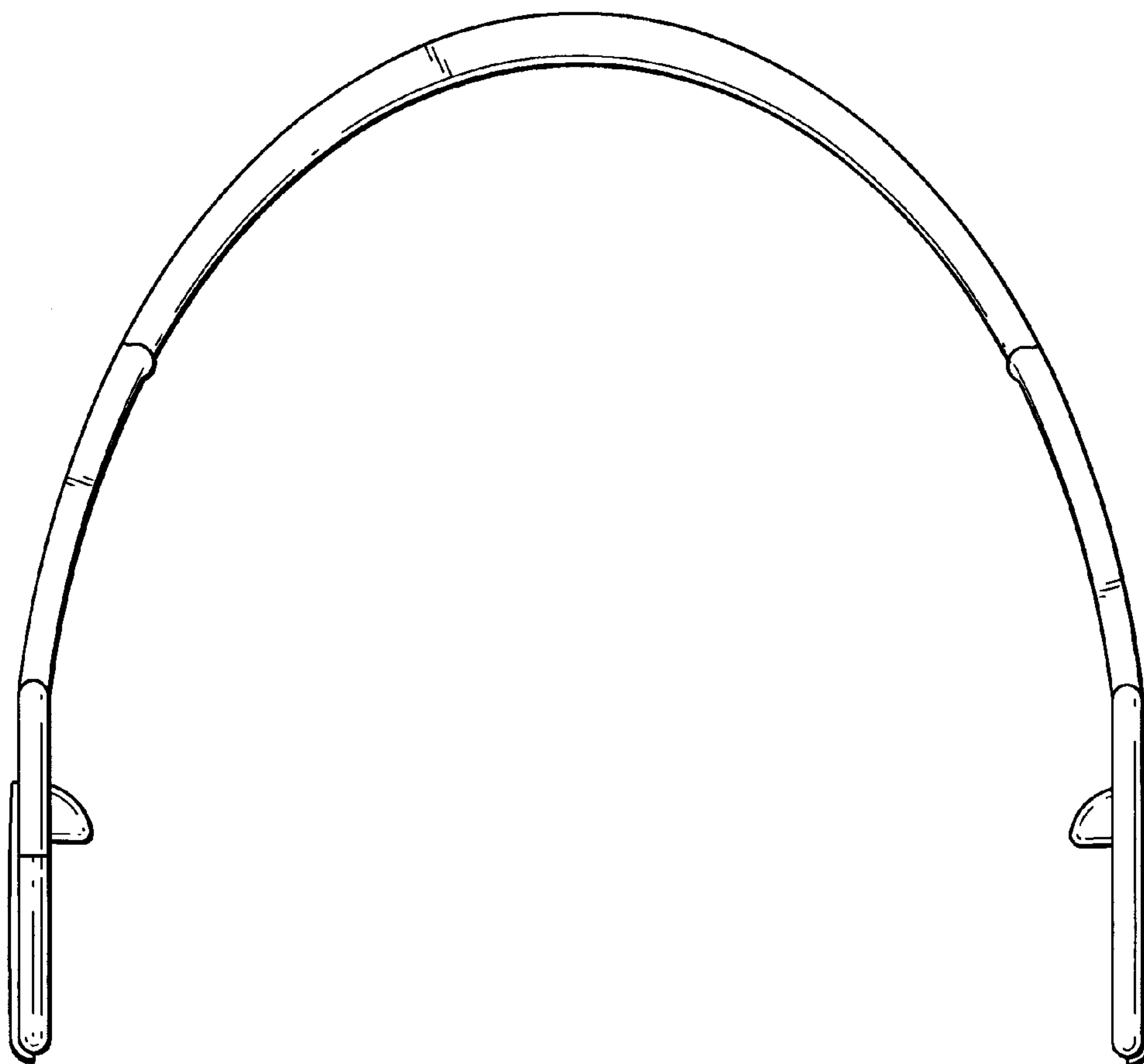

FIG. 6

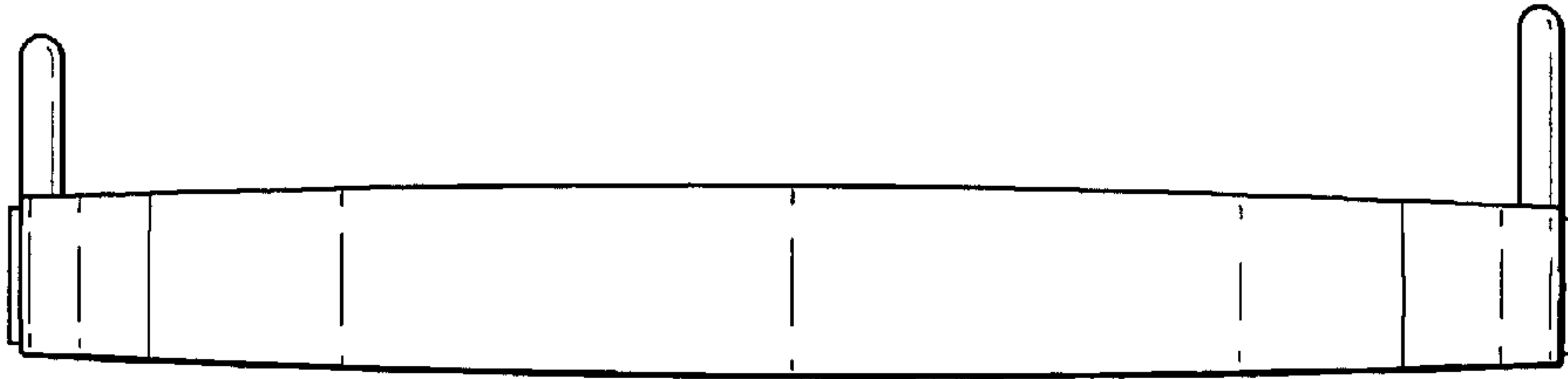

FIG. 7

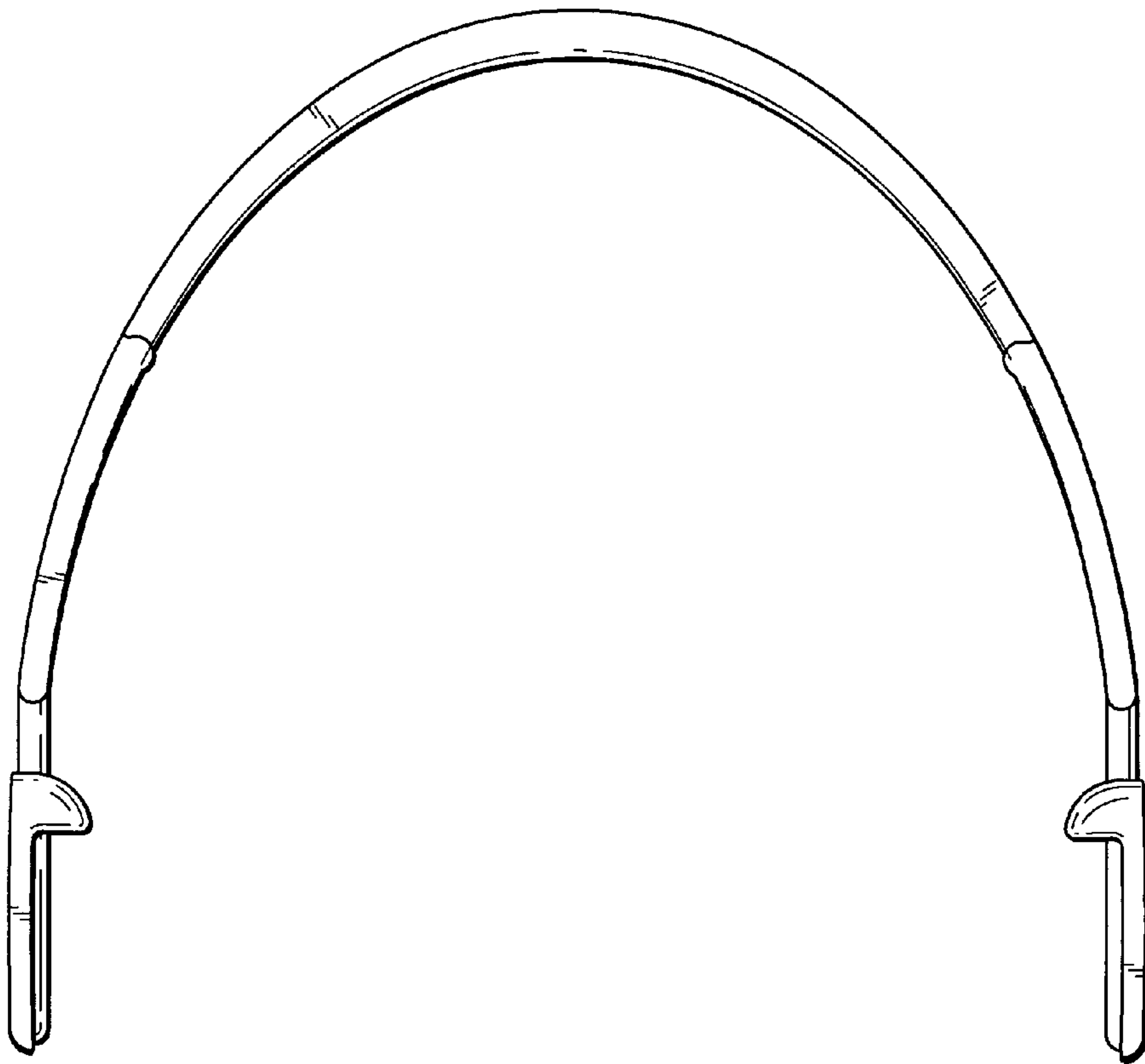

FIG. 8

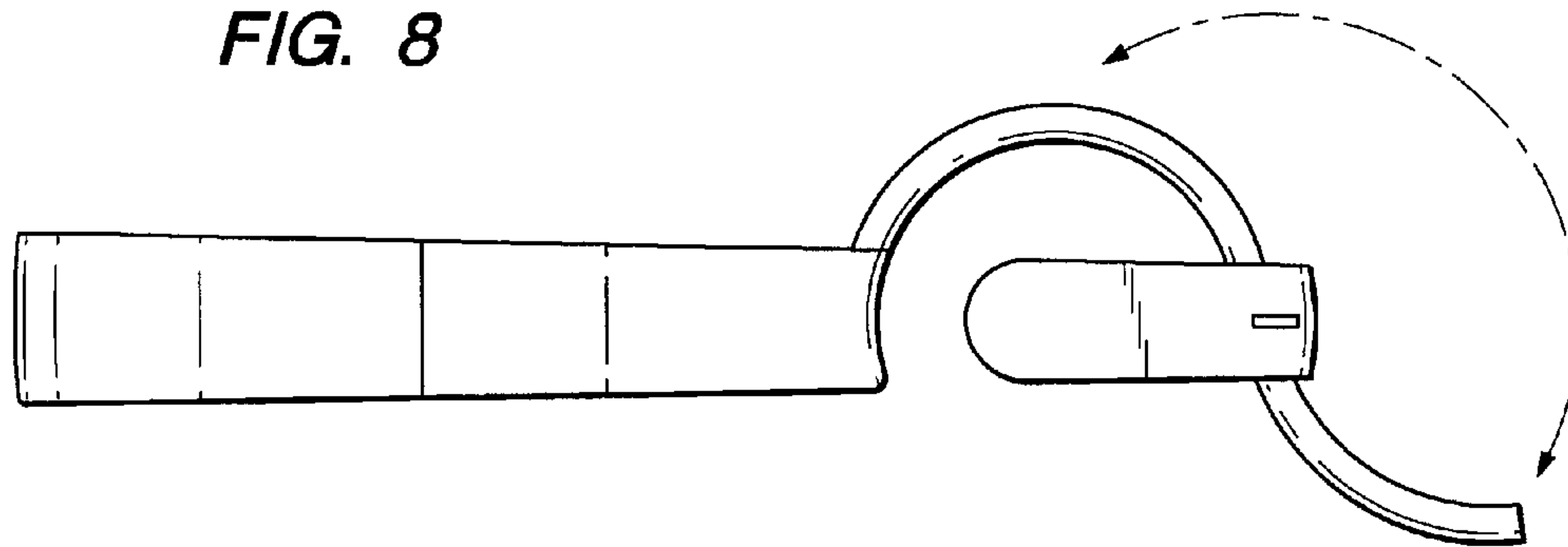

FIG. 9

