



US00D538257S

(12) **United States Design Patent**
Shimizu

(10) **Patent No.:** **US D538,257 S**
(45) **Date of Patent:** **** Mar. 13, 2007**

- (54) **DIGITAL AUDIO DISK PLAYER**
- (75) Inventor: **Akari Shimizu**, Bunkyo-ku (JP)
- (73) Assignee: **Clarion Co., Ltd.**, Tokyo (JP)
- (**) Term: **14 Years**
- (21) Appl. No.: **29/243,323**
- (22) Filed: **Nov. 23, 2005**
- (51) **LOC (8) Cl.** **14-01**
- (52) **U.S. Cl.** **D14/156**
- (58) **Field of Classification Search** D14/135–136,
D14/156–157, 167–168, 192–198, 188, 257,
D14/258, 445; 360/99.02, 99.07; 369/75.11,
369/75.21, 77.21, 77.11; 720/612, 619, 647,
720/655; 455/344, 347–351
See application file for complete search history.

JP	D1229044	5/2002
JP	D1183772	1/2003
JP	D1198278	2/2003
JP	D1211431	11/2003
JP	D1215170	1/2004
JP	D1215171	1/2004
JP	D1216586	2/2004
JP	D1232468	8/2004

* cited by examiner

Primary Examiner—Nanda Bondade
(74) *Attorney, Agent, or Firm*—Oliff & Berridge, PLC

(57) **CLAIM**

The ornamental design for digital audio disk player, as shown and described.

DESCRIPTION

FIG. 1 is a perspective view of a digital audio disk player; FIG. 2 is a front view thereof; FIG. 3 is a rear view thereof; FIG. 4 is a left side view thereof; FIG. 5 is a right side view thereof; FIG. 6 is a top view thereof; FIG. 7 is a bottom view thereof; FIG. 8 is a cross-sectional view thereof taken along the lines 8—8 of FIG. 2; and, FIG. 9 is a cross-sectional view thereof taken along the lines 9—9 of FIG. 2.

The broken lines are for illustrative purposes only and form no part of the claimed design.

(56) **References Cited**

U.S. PATENT DOCUMENTS

D415,491 S	*	10/1999	Yano et al.	D14/168
D421,007 S	*	2/2000	Nagai	D14/156
D427,990 S	*	7/2000	Ito et al.	D14/156
D429,705 S	*	8/2000	Ito et al.	D14/135
D443,868 S	*	6/2001	Ito et al.	D14/168
D475,690 S	*	6/2003	Nose et al.	D14/157

FOREIGN PATENT DOCUMENTS

JP	D1120922	4/2000
JP	D1150107	2/2001

1 Claim, 6 Drawing Sheets

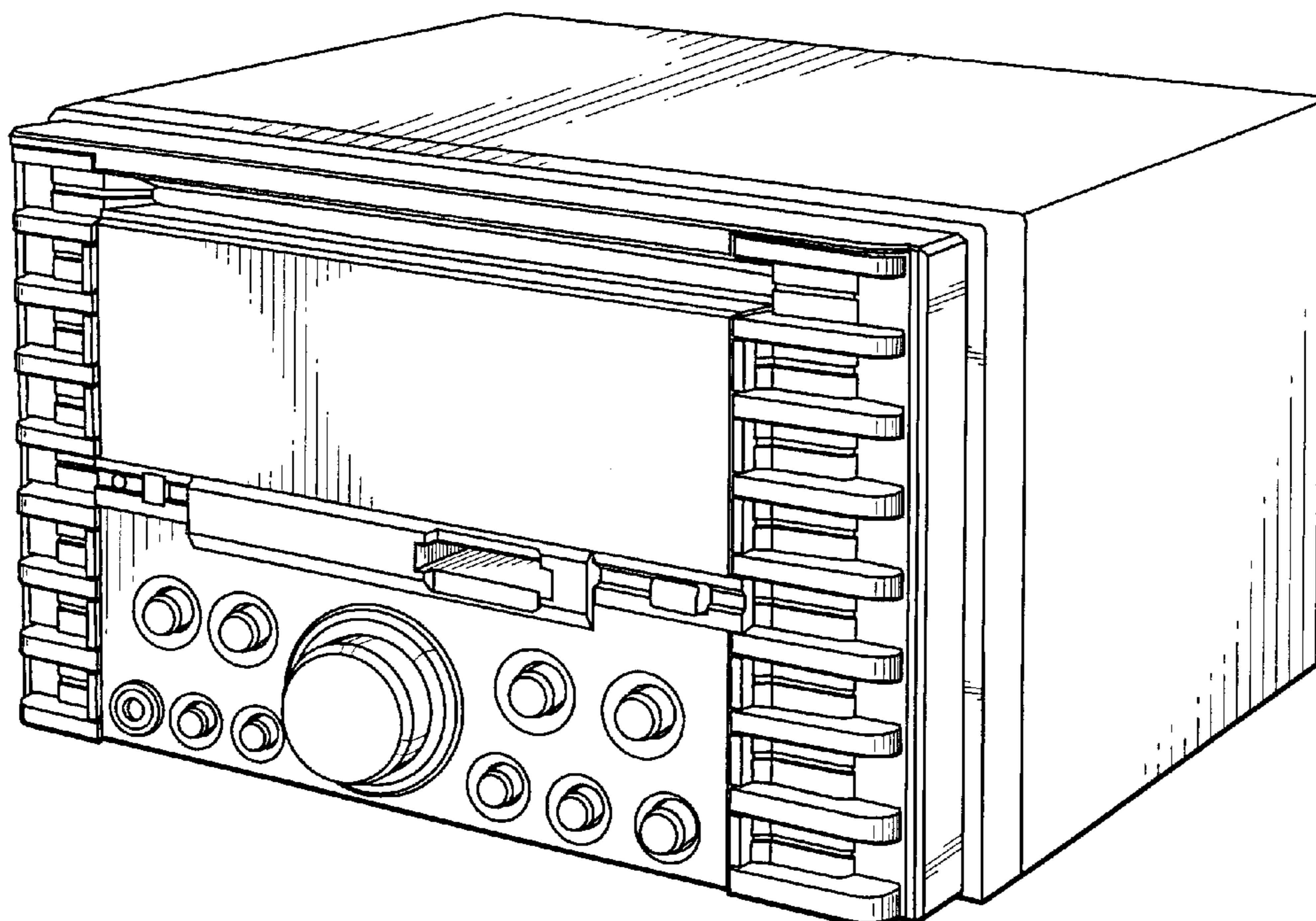

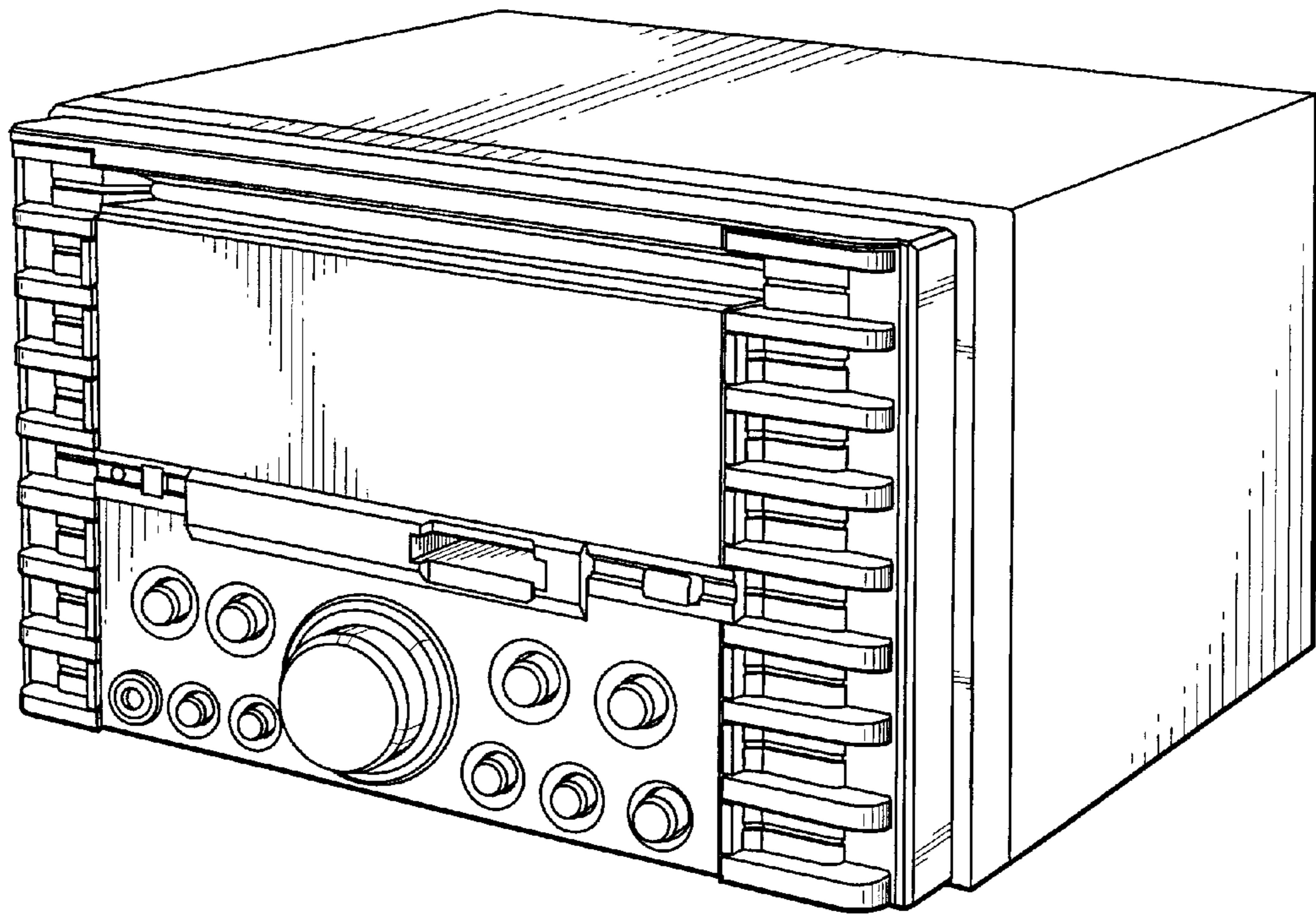

FIG. 1

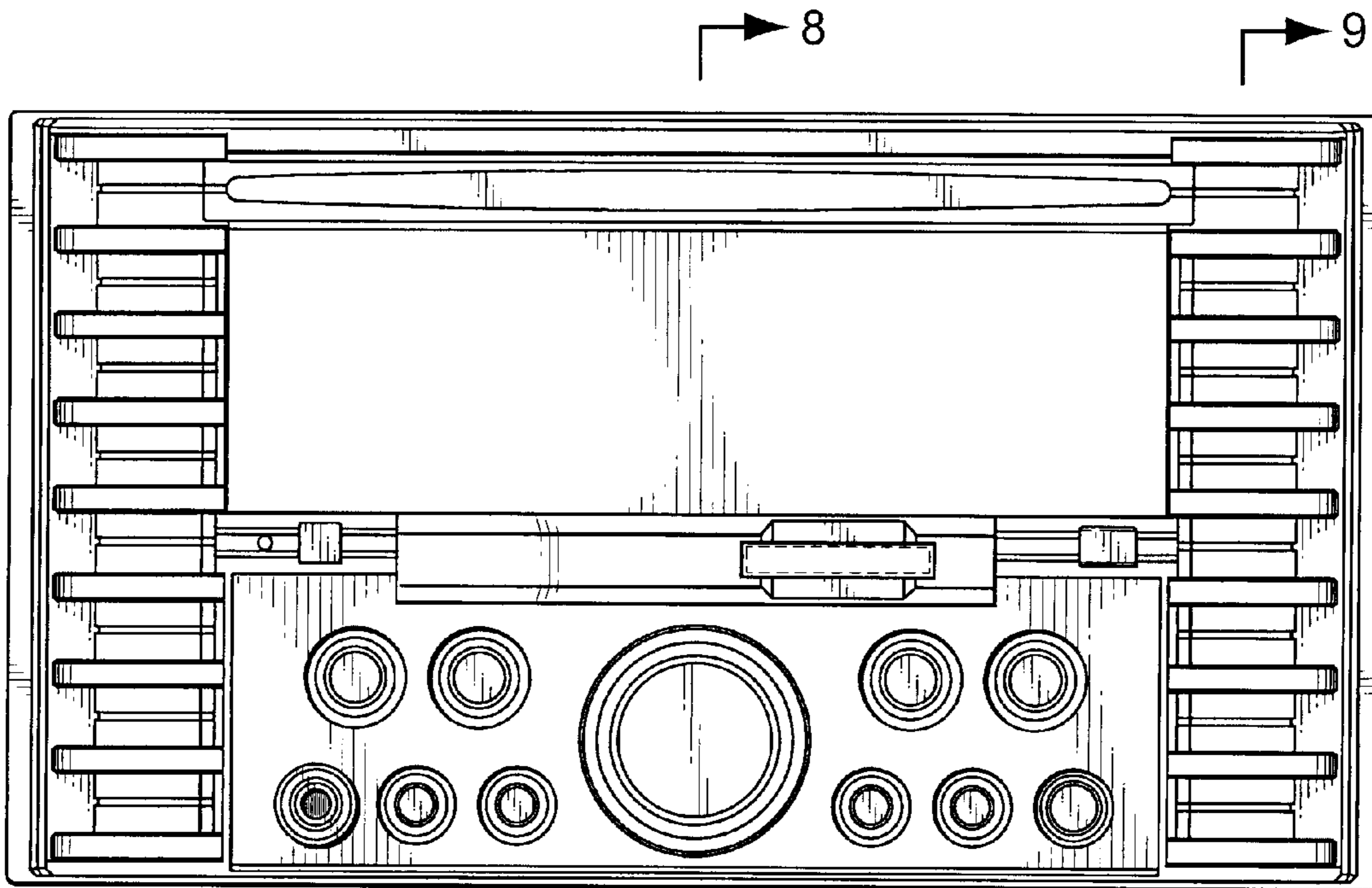

FIG. 2

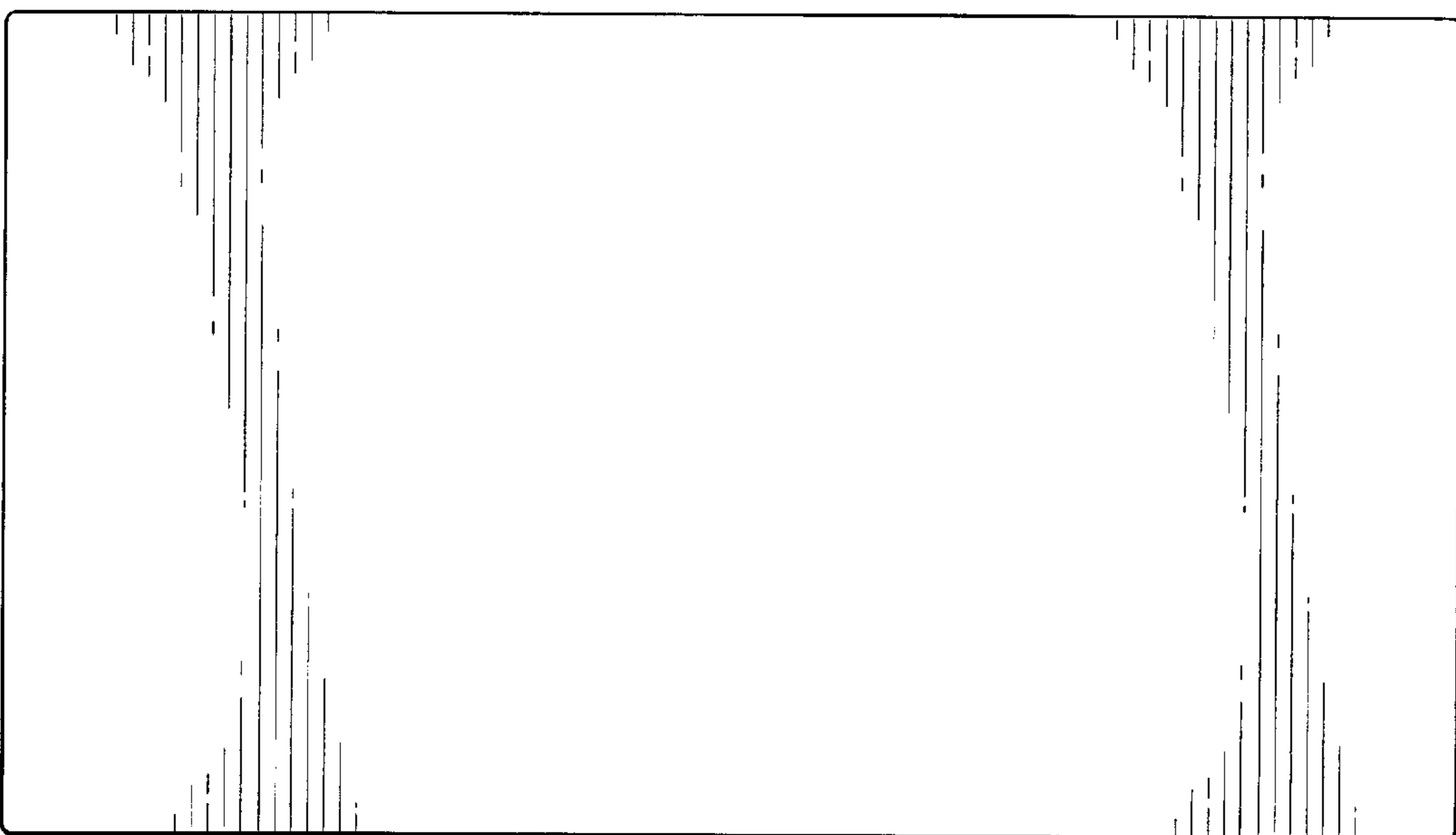

FIG. 3

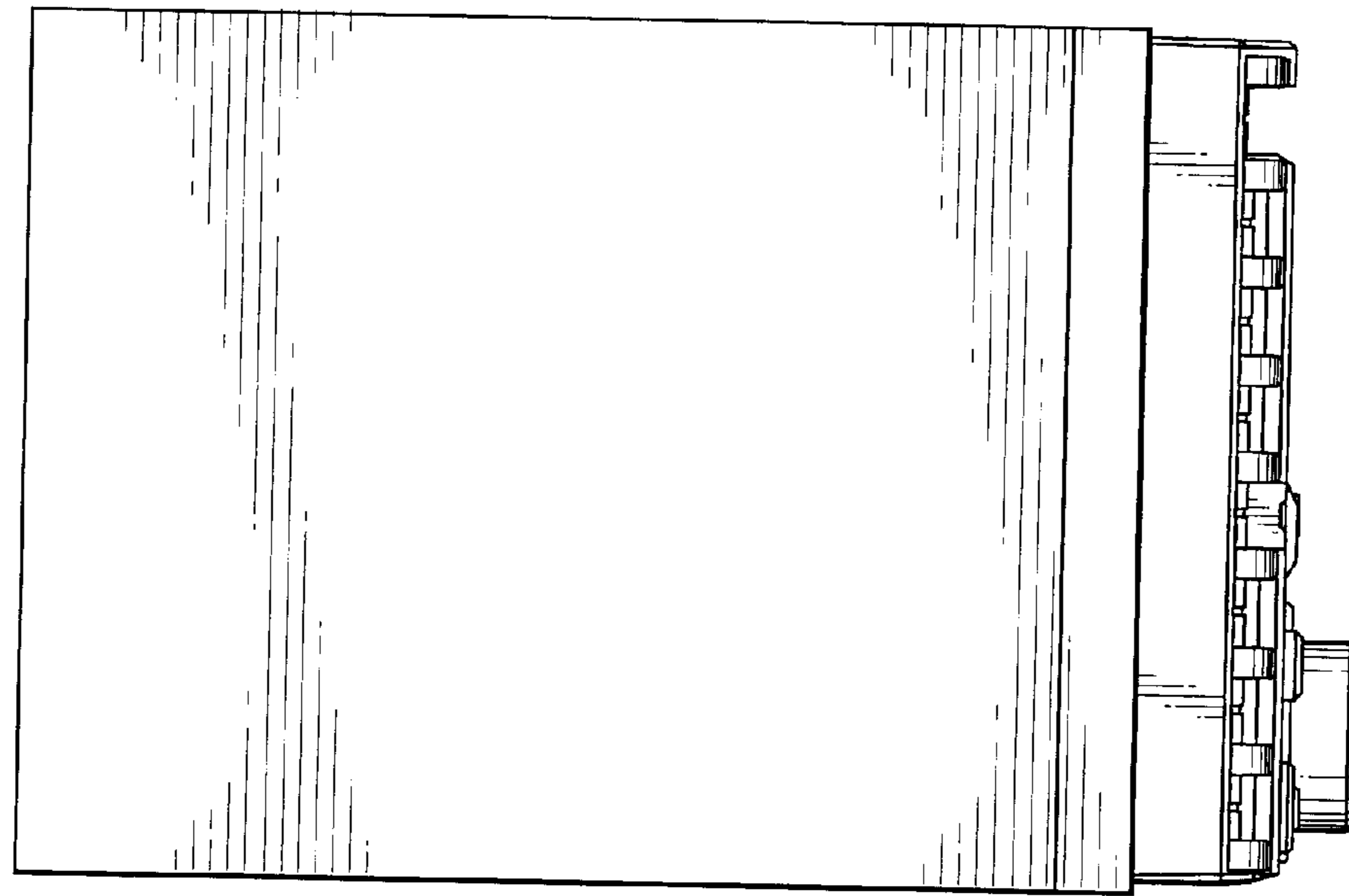

FIG. 4

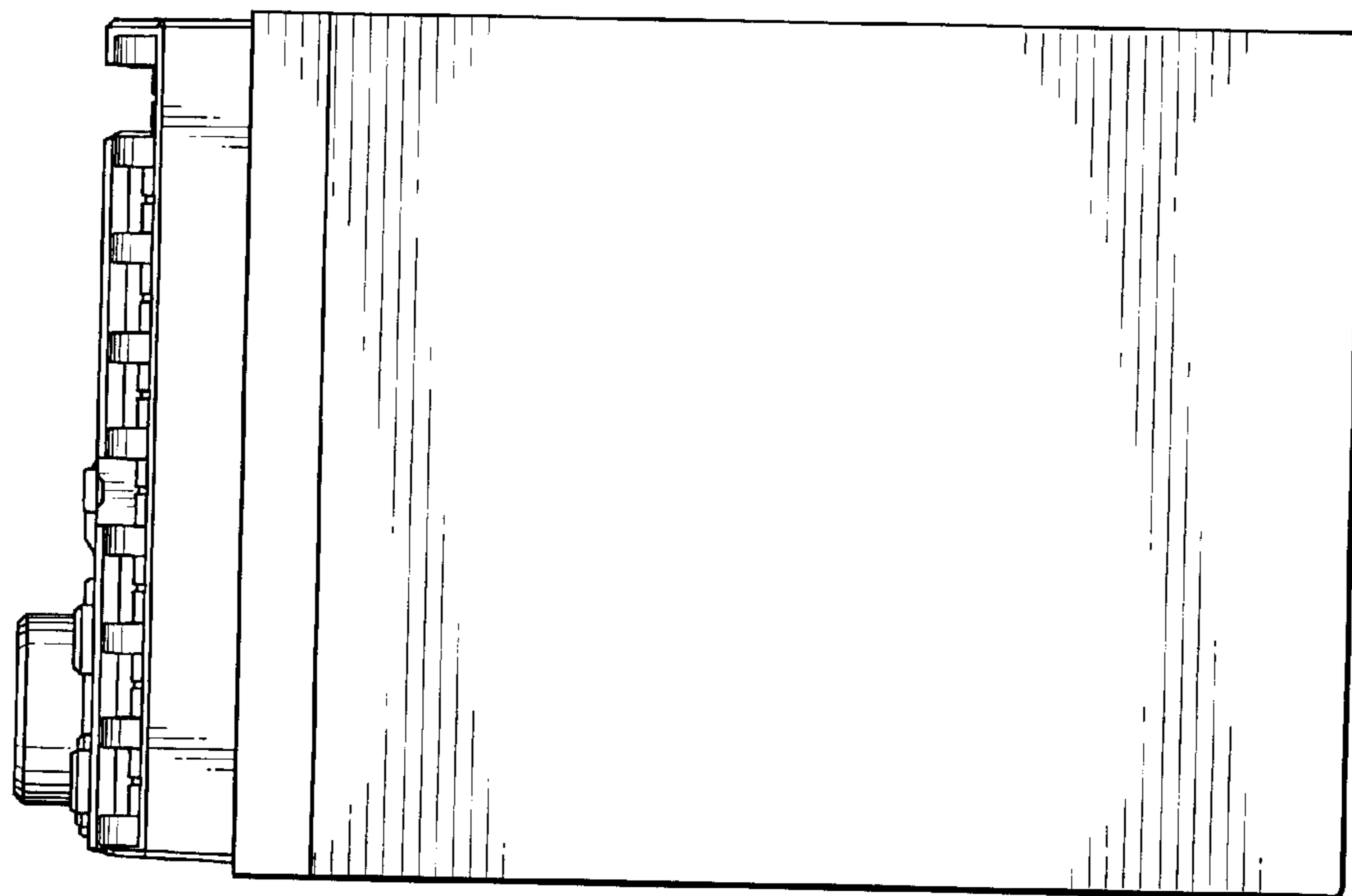

FIG. 5

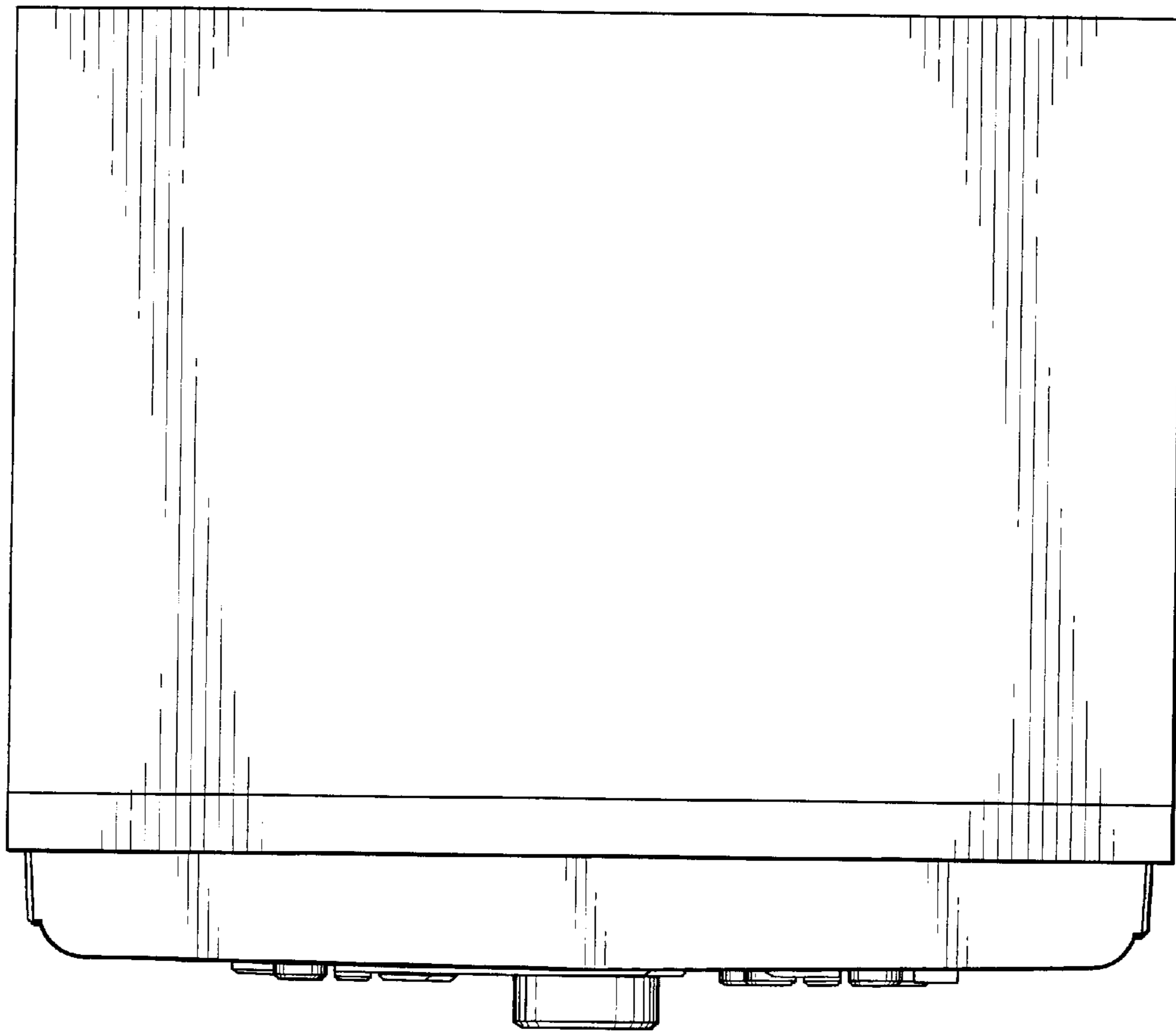

FIG. 6

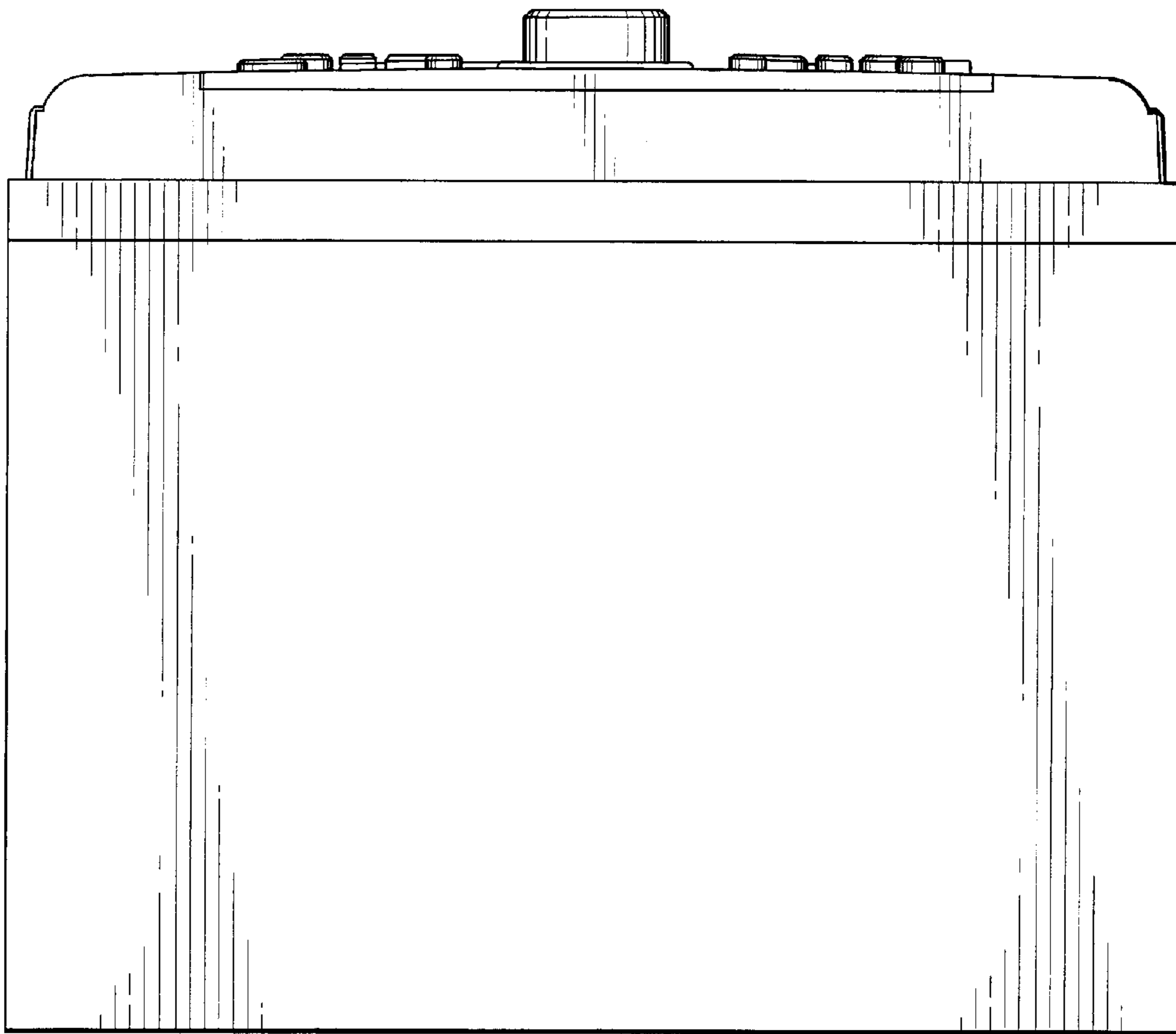

FIG. 7

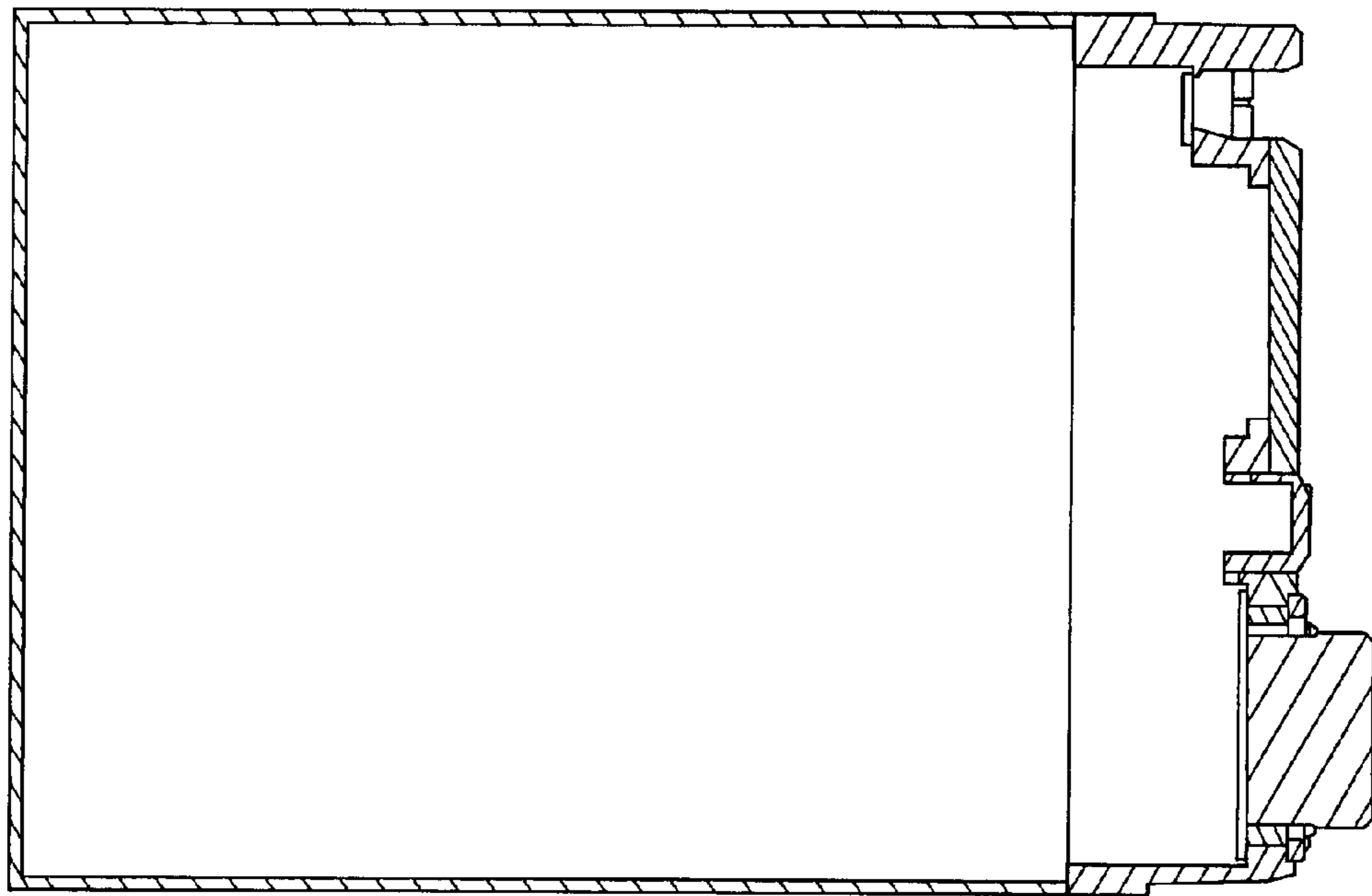

FIG. 8

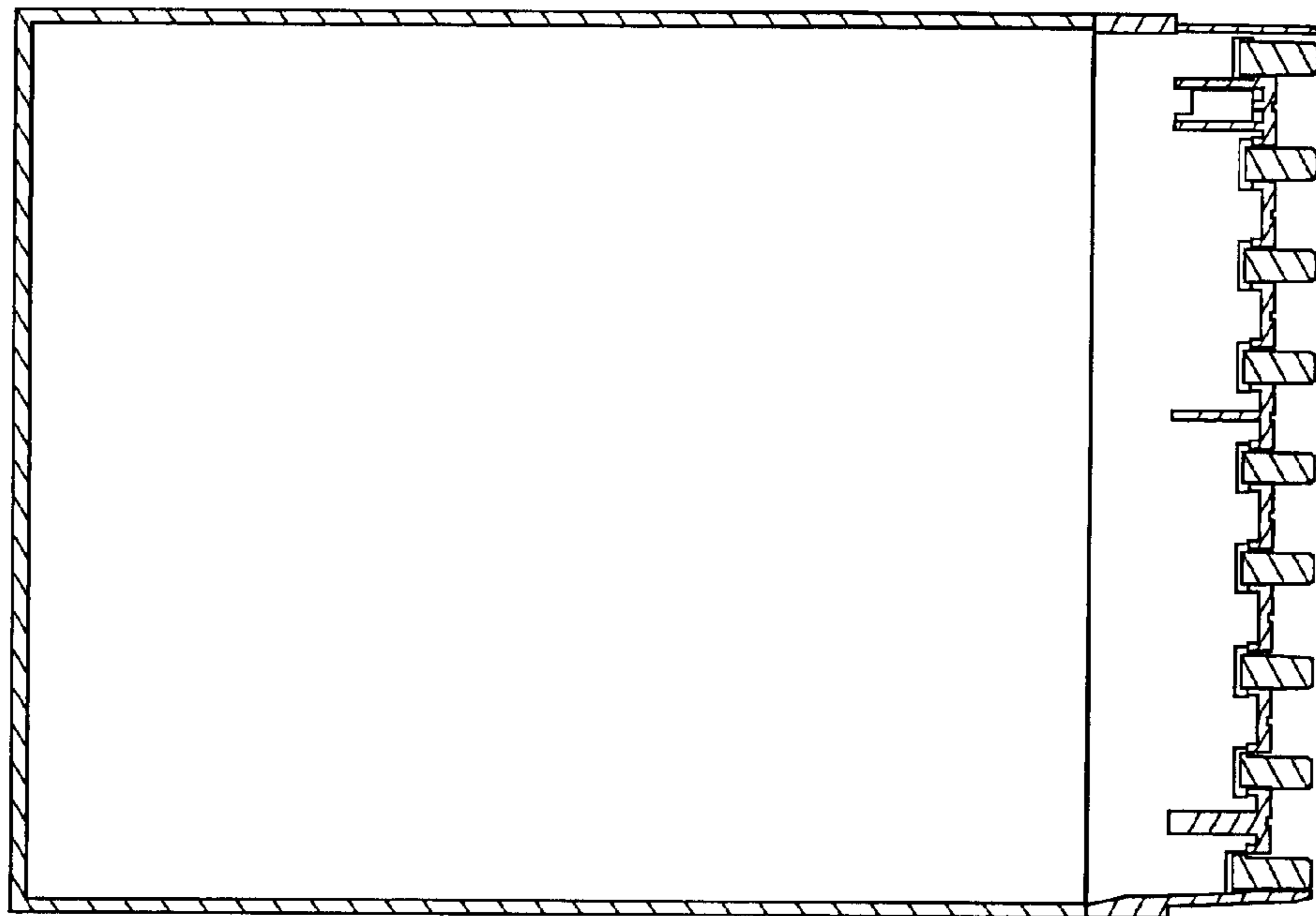

FIG. 9