



US00D538176S

(12) **United States Design Patent**
Wilburn

(10) **Patent No.:** **US D538,176 S**

(45) **Date of Patent:** **** Mar. 13, 2007**

(54) **RACE CAR SOLID STICK DEODORANT DISPENSER**

(75) Inventor: **Connie Wilburn**, Lafayette, TN (US)

(73) Assignee: **WorkHorse L.L.C.**, Lebanon, TN (US)

(**) Term: **14 Years**

(21) Appl. No.: **29/239,599**

(22) Filed: **Sep. 30, 2005**

(51) **LOC (8) Cl.** **09-01**

(52) **U.S. Cl.** **D9/675; D9/729**

(58) **Field of Classification Search** D3/270-271.1,
D3/271.11-271.12; D9/600, 672-675, 723,
D9/727-729; D21/548-549; 220/890; 206/457,
206/459.1, 822, 823; D7/606, 613, 619.2,
D7/628

See application file for complete search history.

(56) **References Cited**

U.S. PATENT DOCUMENTS

D317,118 S	5/1991	Crawford	
D322,395 S	12/1991	Sommer	
D333,977 S	* 3/1993	Gatrost et al. D9/729
D349,632 S	* 8/1994	Nicholson et al. D7/613
D393,021 S	* 3/1998	Box D9/675

D397,868 S	* 9/1998	Huang D3/271.12
D430,279 S	8/2000	Bunce et al.	
6,112,887 A	* 9/2000	Harrison 206/457
D431,457 S	10/2000	Bunce et al.	
D436,527 S	* 1/2001	Bergersen D9/675
D462,431 S	9/2002	Bunce et al.	
D506,036 S	* 6/2005	Mitchell et al. D21/549

* cited by examiner

Primary Examiner—Sandra L. Morris

(74) *Attorney, Agent, or Firm*—Sturm & Fix LLP

(57) **CLAIM**

The ornamental design for a race car solid stick deodorant dispenser, as shown and described.

DESCRIPTION

FIG. 1 is a perspective view of the race car solid stick deodorant dispenser showing my new design;
 FIG. 2 is a perspective view thereof showing the cap of the dispenser removed;
 FIG. 3 is a right side elevational view thereof, the left side elevational view being identical thereto;
 FIG. 4 is a top plan view thereof;
 FIG. 5 is a bottom plan view thereof;
 FIG. 6 is a front elevational view thereof; and,
 FIG. 7 is a rear elevational view thereof.

1 Claim, 3 Drawing Sheets

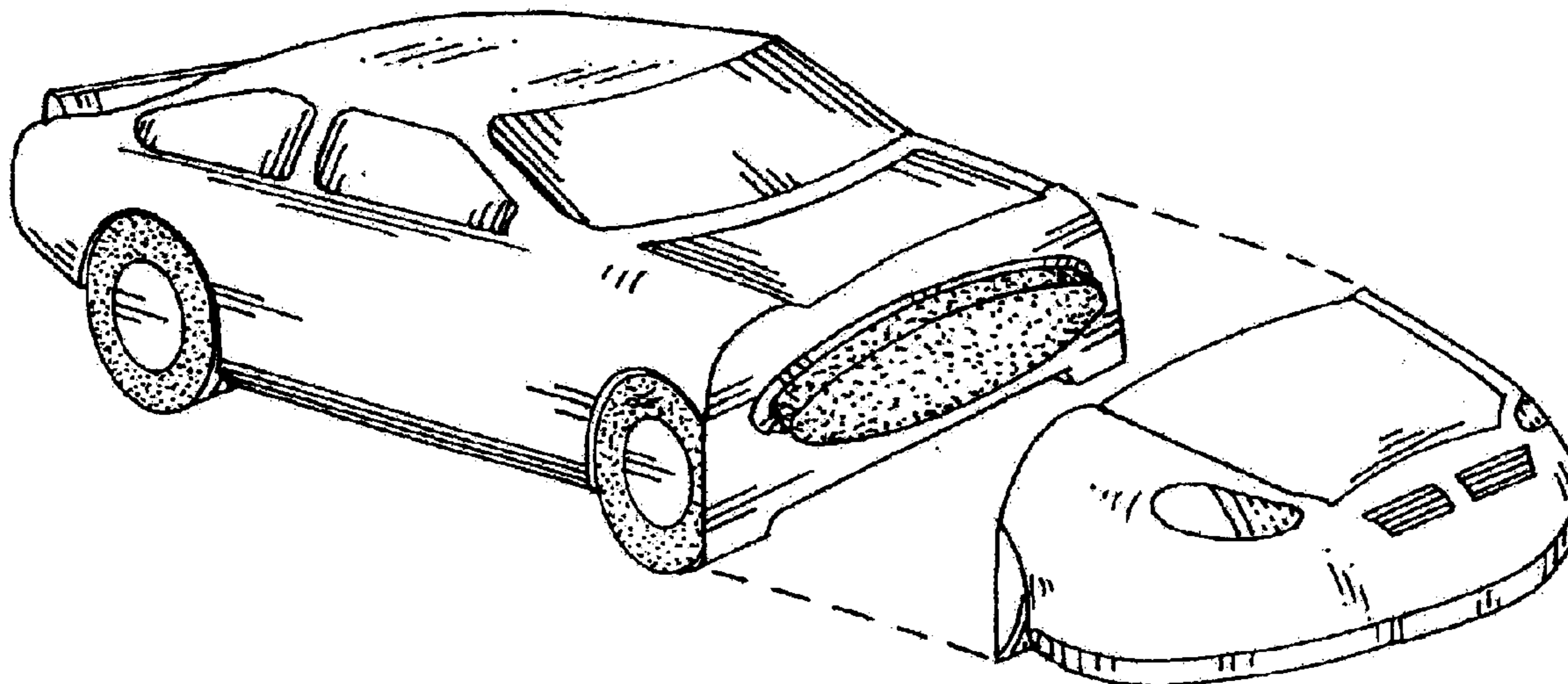

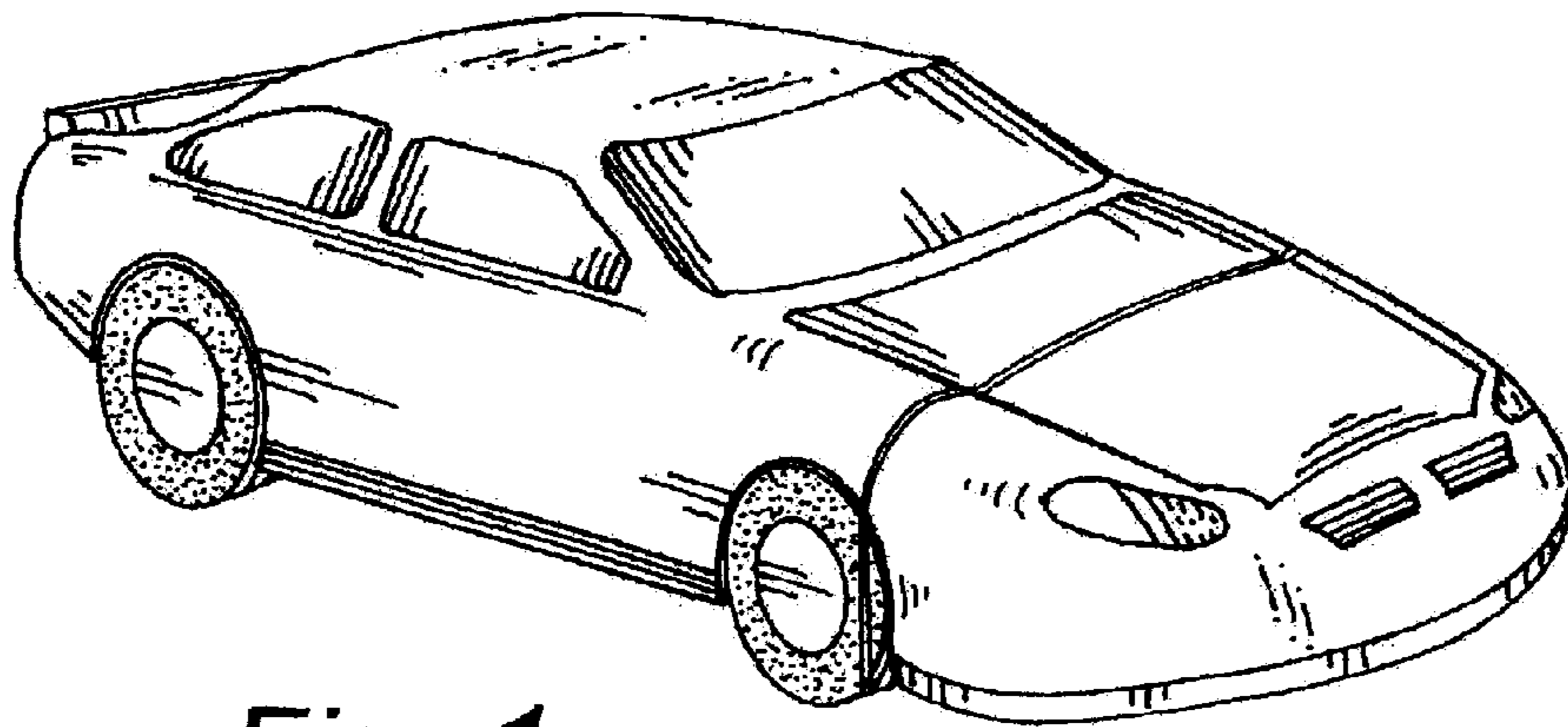

Fig. 1

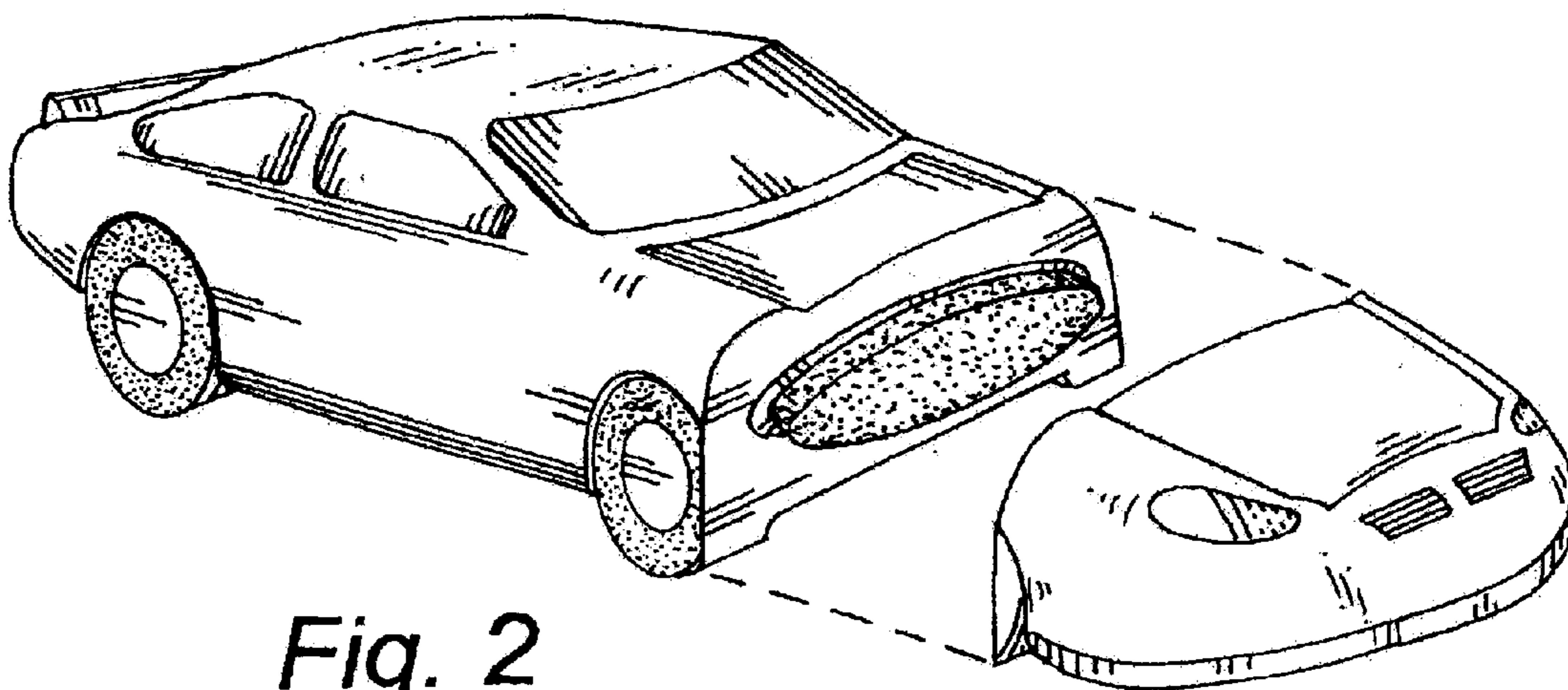

Fig. 2

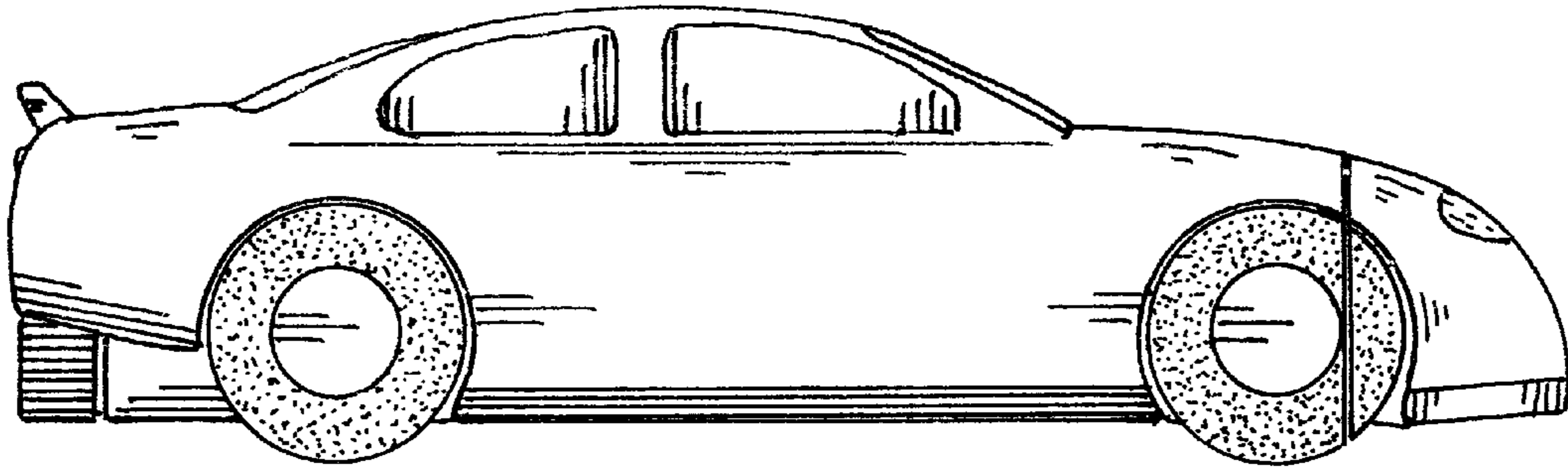

Fig. 3

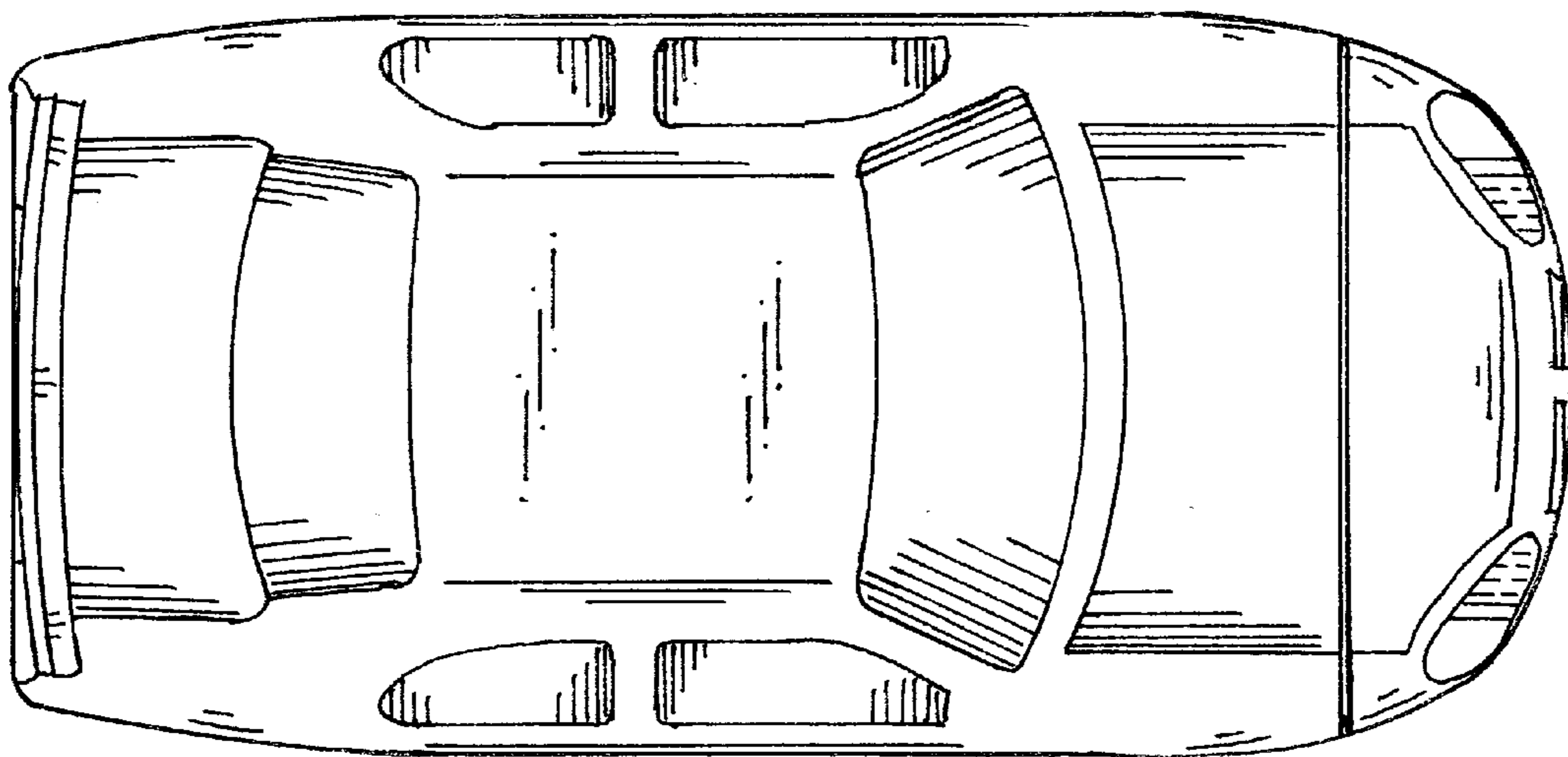

Fig. 4

Fig. 5

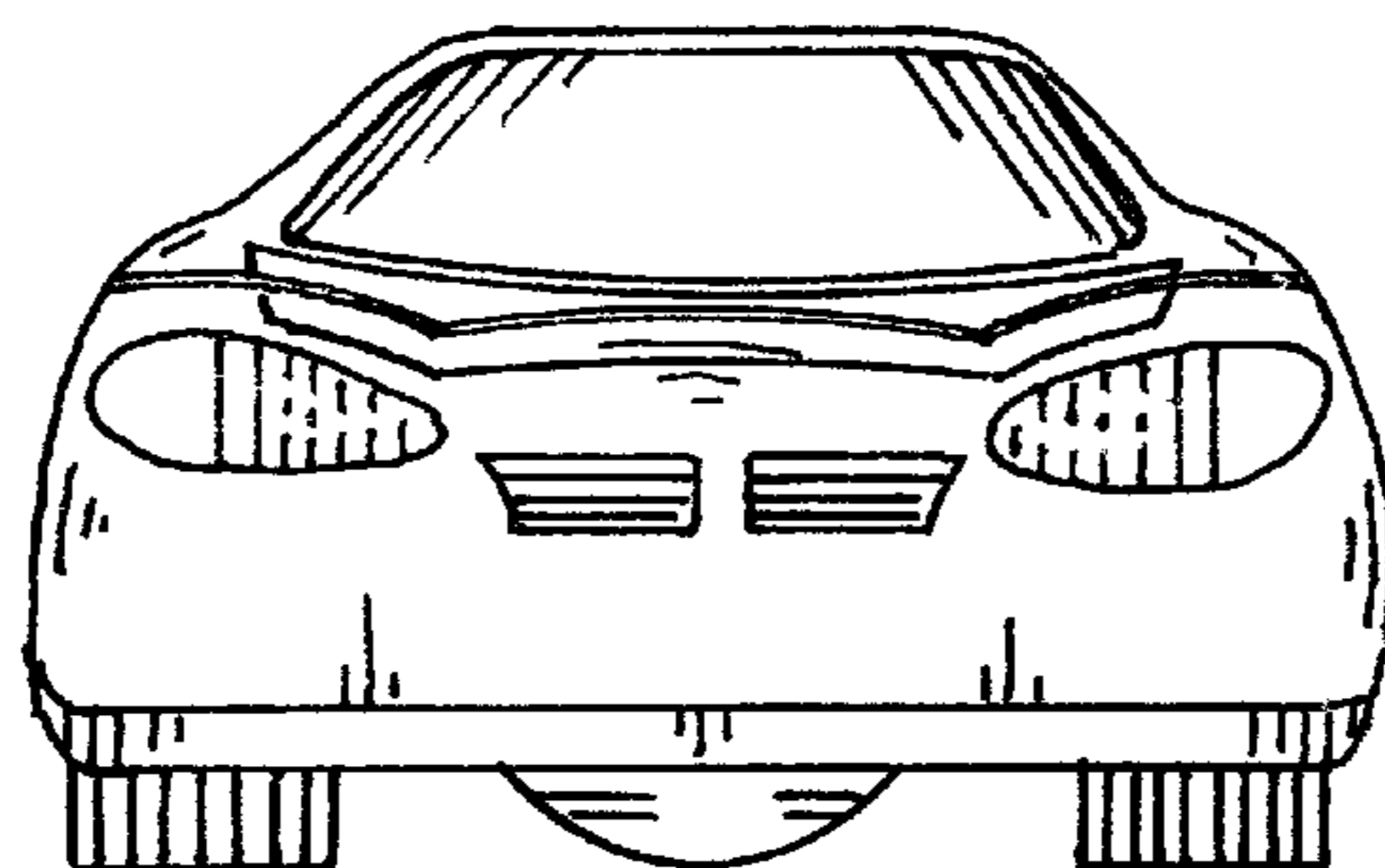
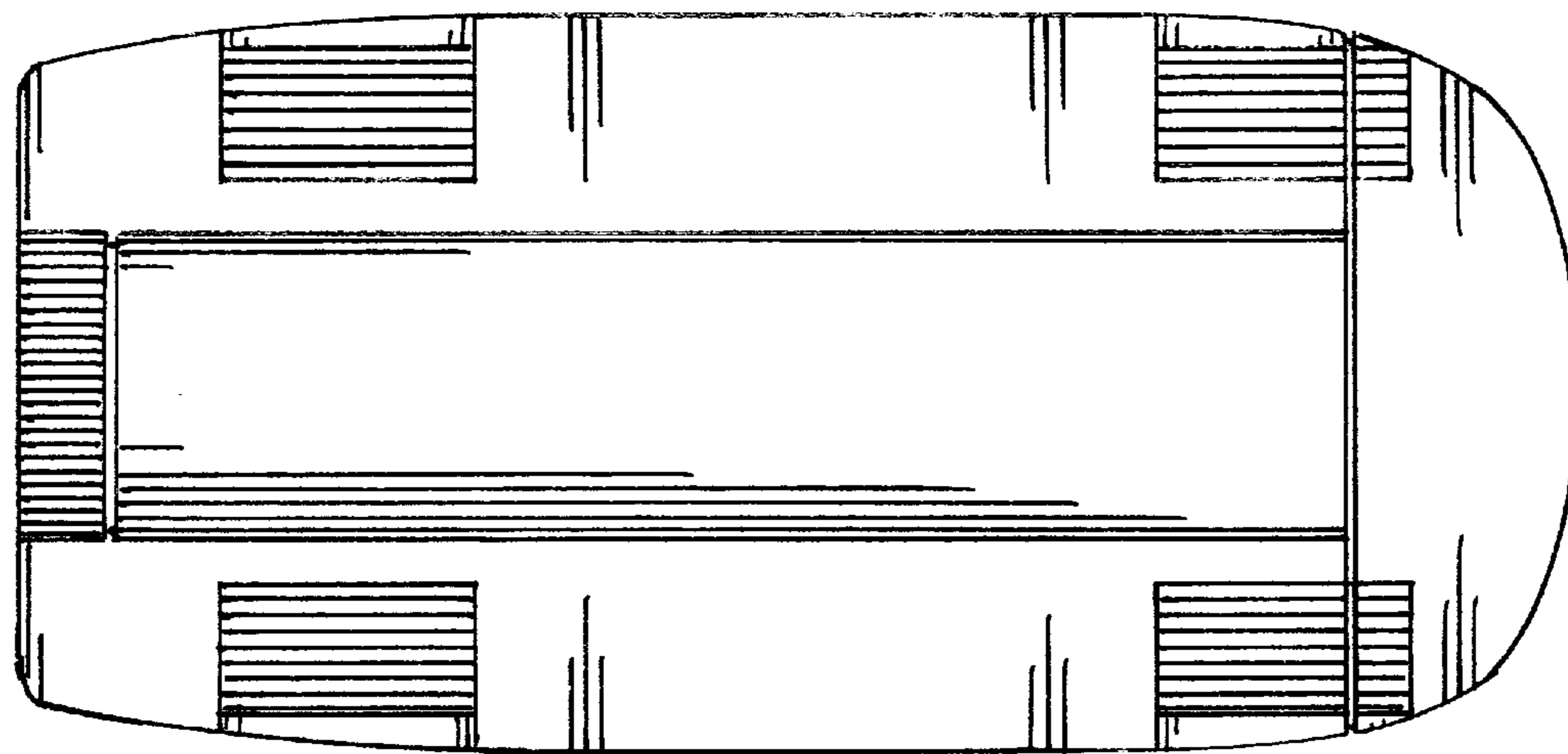

Fig. 6

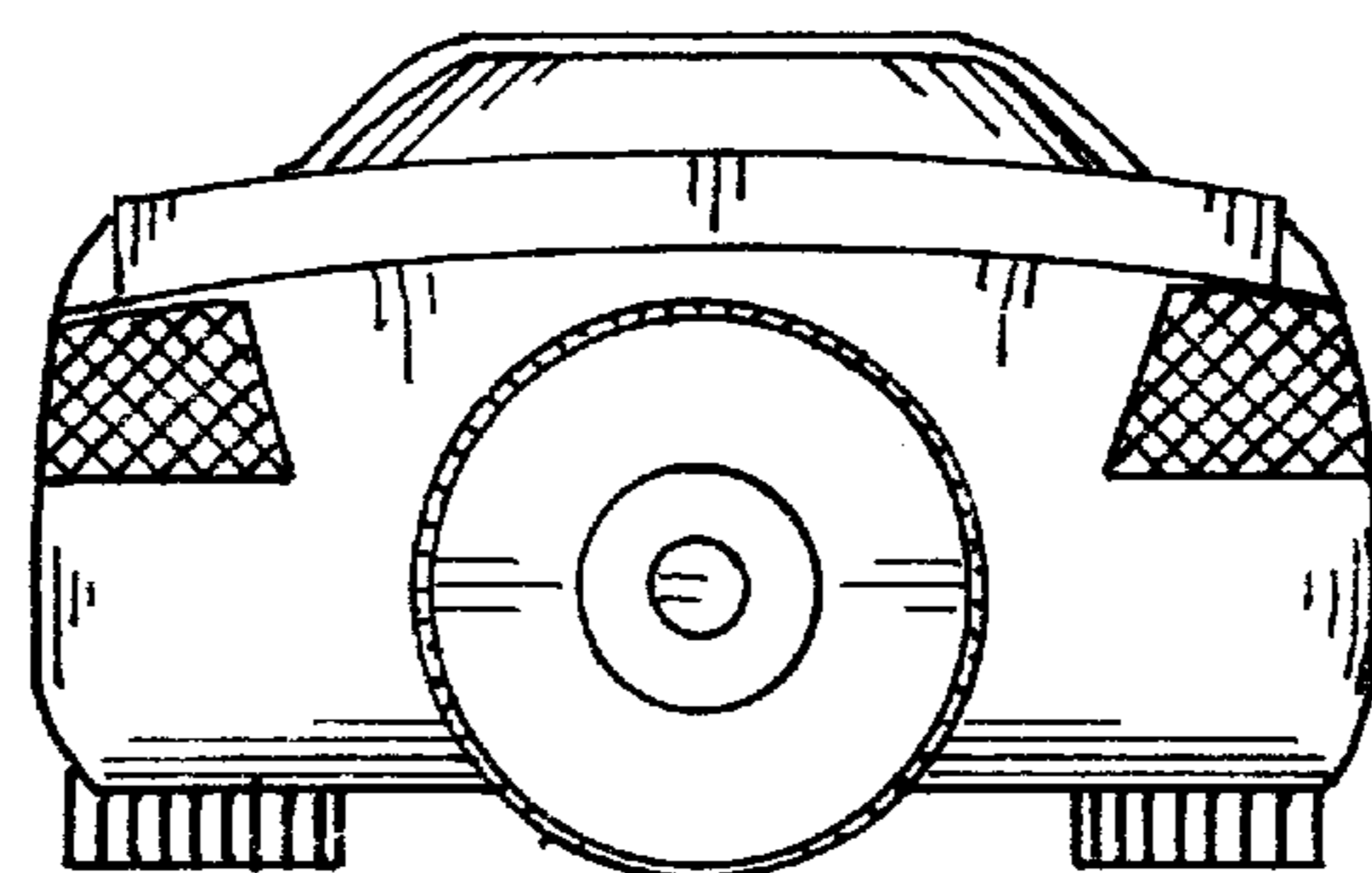

Fig. 7