



US00D537809S

(12) **United States Design Patent**  
**Shiono**

(10) **Patent No.:** **US D537,809 S**  
(45) **Date of Patent:** **\*\* Mar. 6, 2007**

(54) **DISC PLAYER**  
(75) Inventor: **Daisuke Shiono**, Tokyo (JP)  
(73) Assignee: **Sony Corporation**, Tokyo (JP)  
(\*\*) Term: **14 Years**

D487,447 S \* 3/2004 Sadatsuki ..... D14/156  
D487,448 S \* 3/2004 Sadatsuki ..... D14/157  
D496,647 S 9/2004 Sogabe  
D506,456 S \* 6/2005 Shindo ..... D14/156

\* cited by examiner

(21) Appl. No.: **29/245,285**  
(22) Filed: **Dec. 22, 2005**

*Primary Examiner*—Nanda Bondade  
(74) *Attorney, Agent, or Firm*—Rader, Fishman & Grauer PLLC

(30) **Foreign Application Priority Data**

Jul. 26, 2005 (JP) ..... 2005-021655

(57) **CLAIM**

The ornamental design for a disc player, as shown.

(51) **LOC (8) Cl.** ..... **14-01**  
(52) **U.S. Cl.** ..... **D14/156; D14/157**  
(58) **Field of Classification Search** ..... D14/135–136,  
D14/156–157, 167–168, 192–198, 188, 257,  
D14/258, 445; 360/99.02, 99.07; 369/75.11,  
369/75.21, 77.21, 77.11; 720/612, 619, 647,  
720/655; 455/344, 347–351

**DESCRIPTION**

FIG. 1 is a perspective view of a disc player showing my new design.  
FIG. 2 is a front elevational view thereof;  
FIG. 3 is a rear elevational view thereof;  
FIG. 4 is a left side elevational view thereof;  
FIG. 5 is a right side elevational view thereof;  
FIG. 6 is a top plan view thereof; and,  
FIG. 7 is a bottom plan view thereof.

See application file for complete search history.

All the material from the Japanese Application which is essential to the claimed design is included in this application. Any material in the Japanese application which is not present in this application forms no part of the claimed design.

(56) **References Cited**

**U.S. PATENT DOCUMENTS**

D400,529 S \* 11/1998 Kakizaki ..... D14/157  
5,859,828 A \* 1/1999 Ishibashi ..... 720/655  
D480,701 S \* 10/2003 Sogabe ..... D14/156  
D481,373 S 10/2003 Sogabe

**1 Claim, 7 Drawing Sheets**

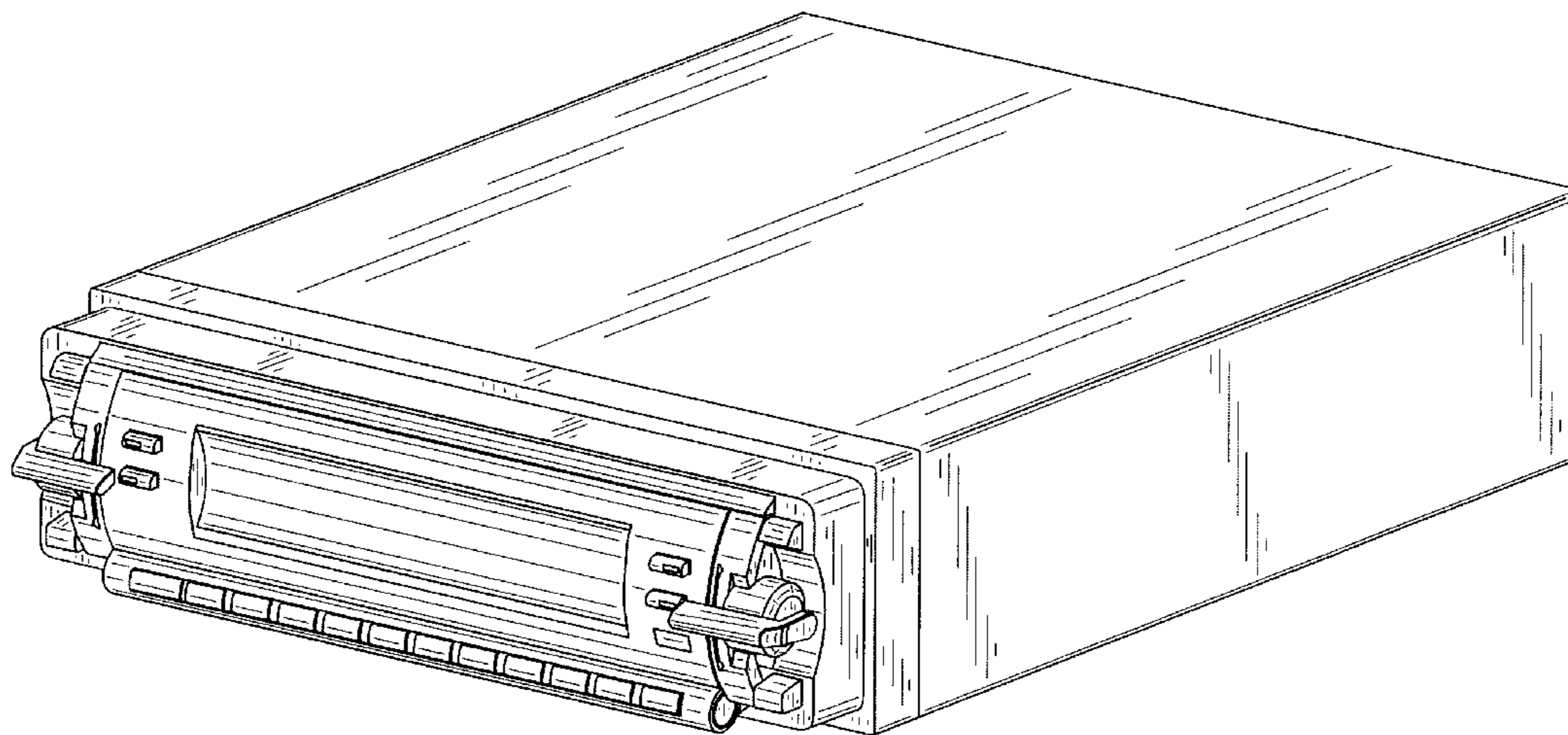

Fig. 1

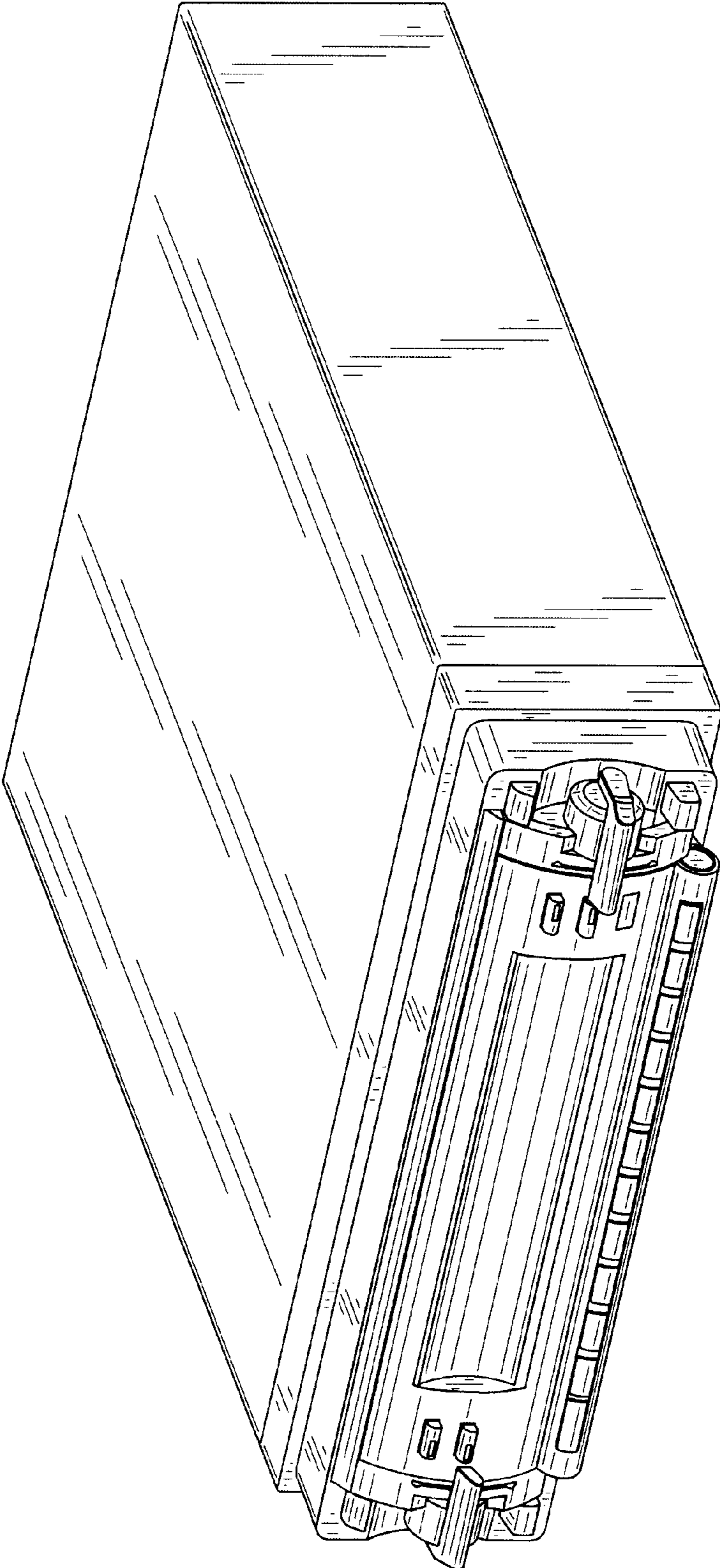

Fig.2

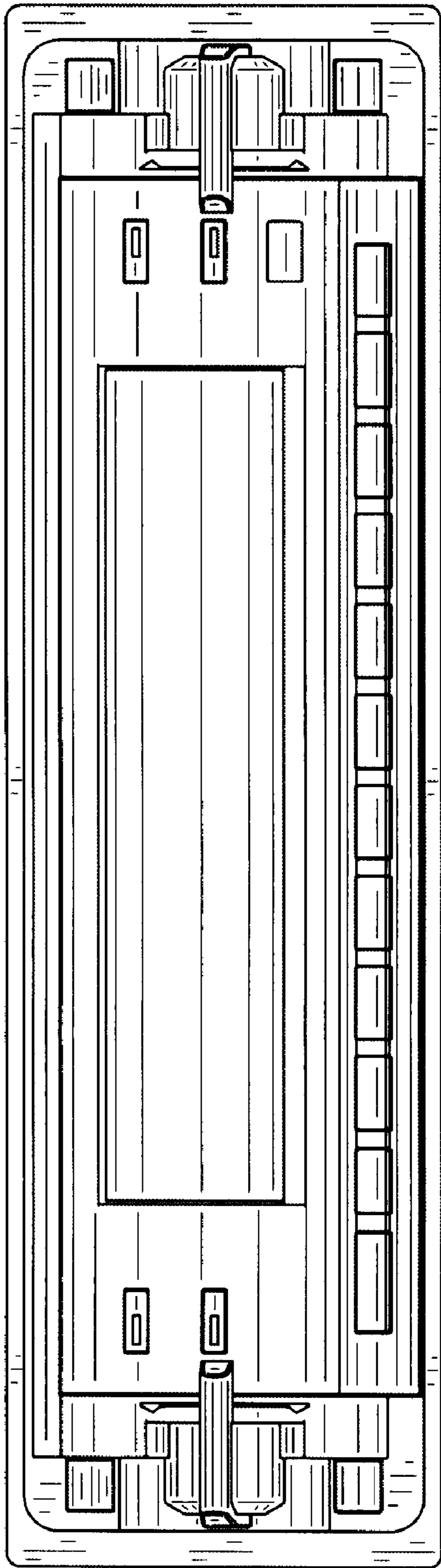

Fig.3

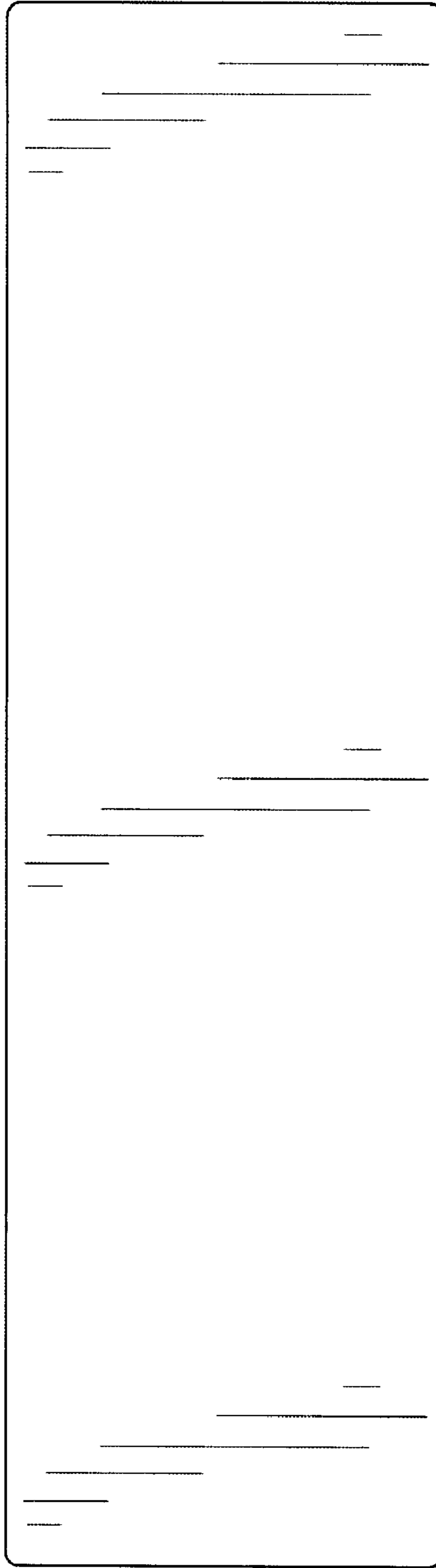

Fig. 4

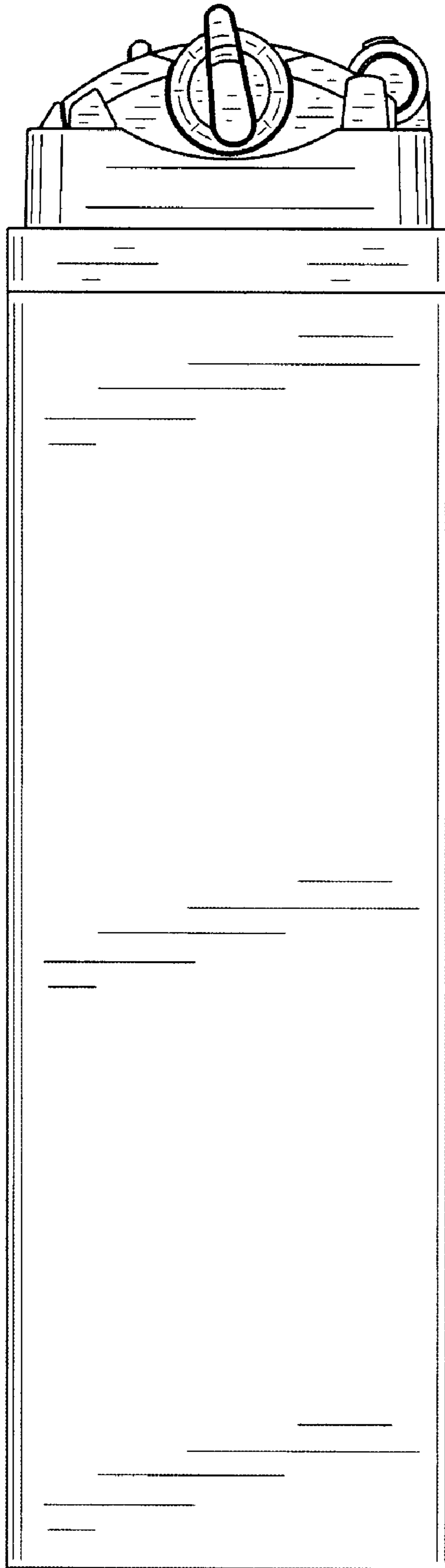

Fig. 5

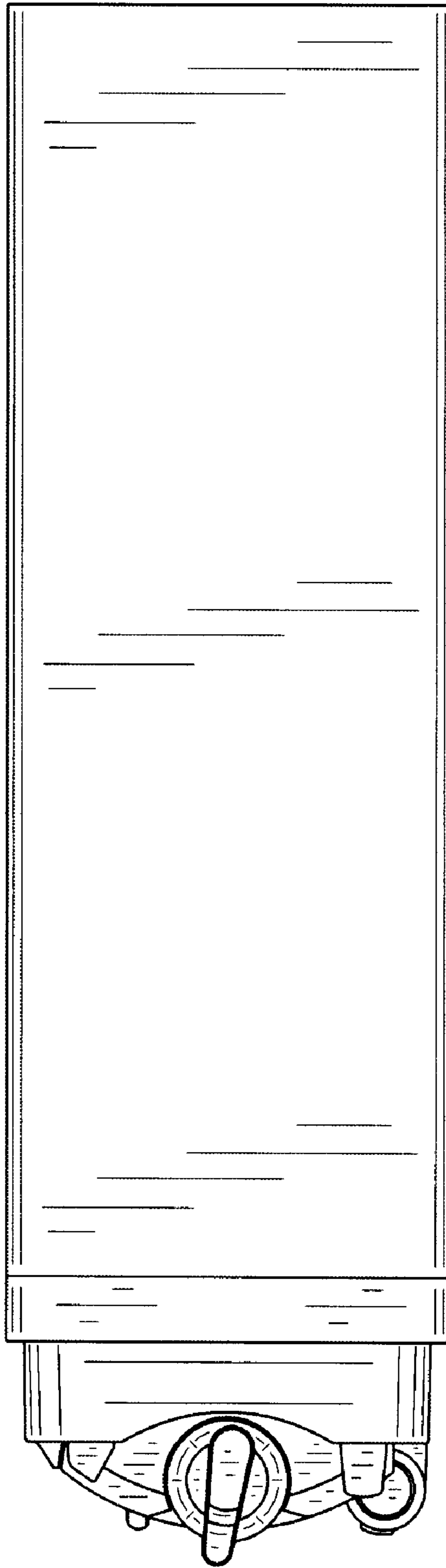

Fig.6

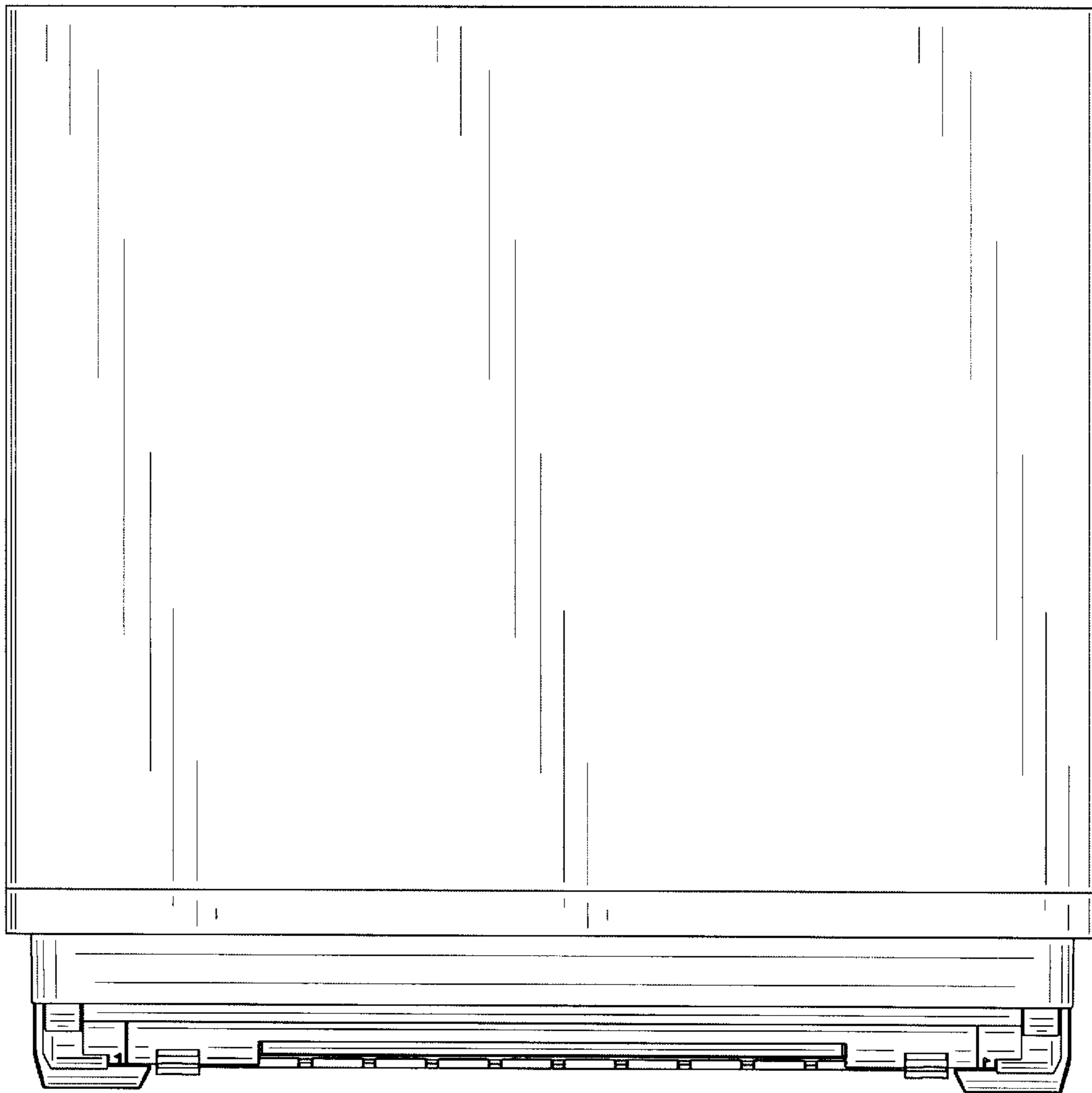

Fig.7

