



US00D537780S

(12) **United States Design Patent**  
**Suckle**

(10) **Patent No.:** **US D537,780 S**

(45) **Date of Patent:** **\*\* Mar. 6, 2007**

(54) **HDMI EXTENDER**

D478,548 S \* 8/2003 Wu ..... D13/133

(75) Inventor: **Mitchell Suckle**, Long Beach, CA (US)

\* cited by examiner

(73) Assignee: **Belkin Corporation**, Compton, CA (US)

*Primary Examiner*—Alan P. Douglas  
*Assistant Examiner*—Deanna Fluegeman

(\*\*) Term: **14 Years**

(74) *Attorney, Agent, or Firm*—Bryan Cave LLP

(21) Appl. No.: **29/220,749**

(57) **CLAIM**

(22) Filed: **Jan. 4, 2005**

I claim the ornamental design for an HDMI extender, as shown and described.

(51) **LOC (8) Cl.** ..... **13-03**

(52) **U.S. Cl.** ..... **D13/133**

(58) **Field of Classification Search** ..... D13/133,  
D13/154; 439/607

See application file for complete search history.

**DESCRIPTION**

(56) **References Cited**

**U.S. PATENT DOCUMENTS**

- D363,269 S \* 10/1995 Riley et al. .... D13/133
- D373,567 S \* 9/1996 Rak et al. .... D13/133
- D411,175 S \* 6/1999 Doren et al. .... D13/154
- 6,454,462 B2 \* 9/2002 Nguyen et al. .... 385/53
- D470,819 S \* 2/2003 Sass et al. .... D13/133

FIG. 1 is a top view of the HDMI extender;  
 FIG. 2 is a bottom view thereof;  
 FIG. 3 is a front elevational view thereof;  
 FIG. 4 is a rear elevational view thereof;  
 FIG. 5 is a left side elevational view thereof;  
 FIG. 6 is a right side elevational view thereof;  
 FIG. 7 is a front, left, bottom perspective view thereof; and,  
 FIG. 8 is a rear, right, bottom perspective view thereof.  
 The broken lines in the drawings are for illustrative purposes only and form no part of the claimed design.

**1 Claim, 2 Drawing Sheets**

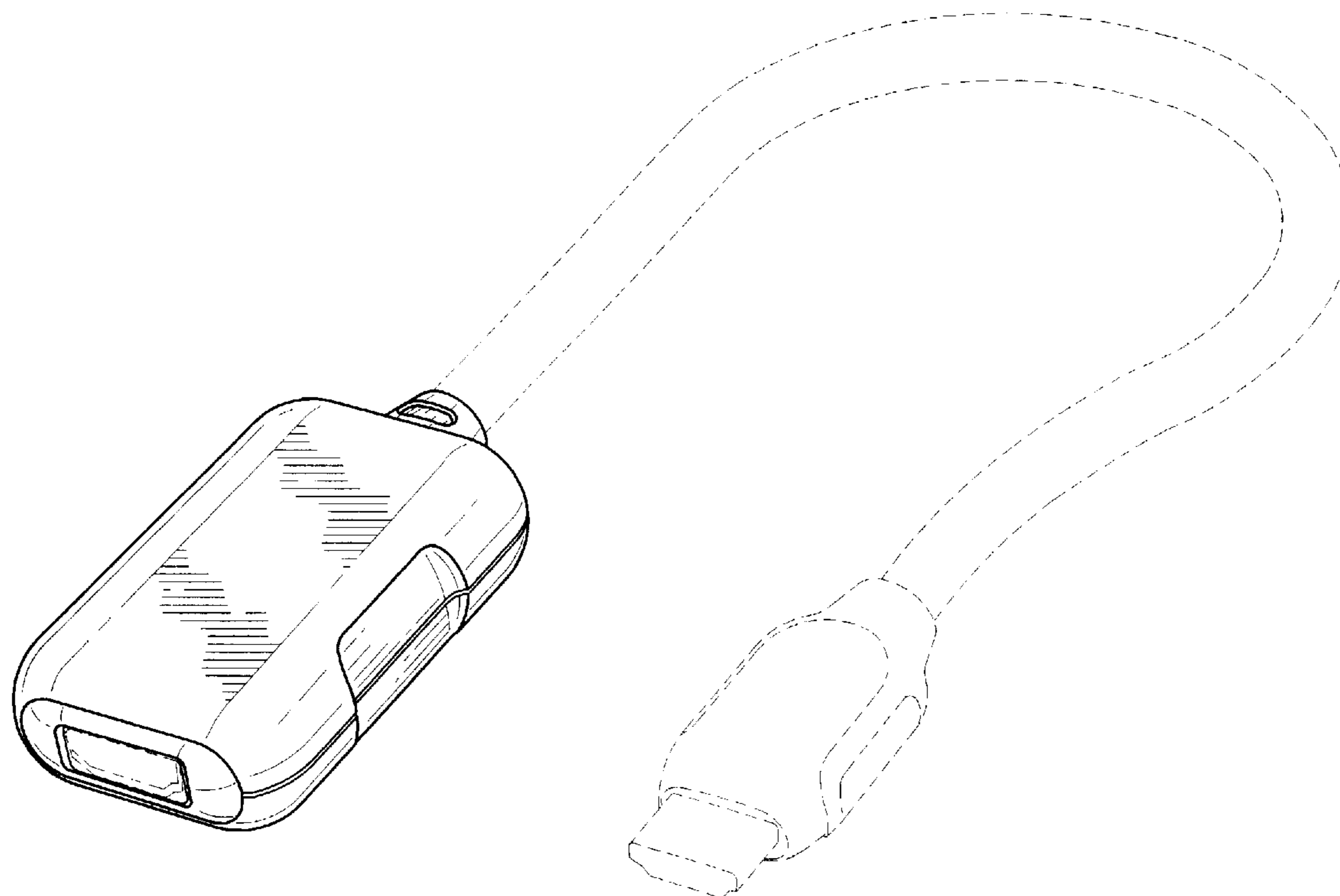

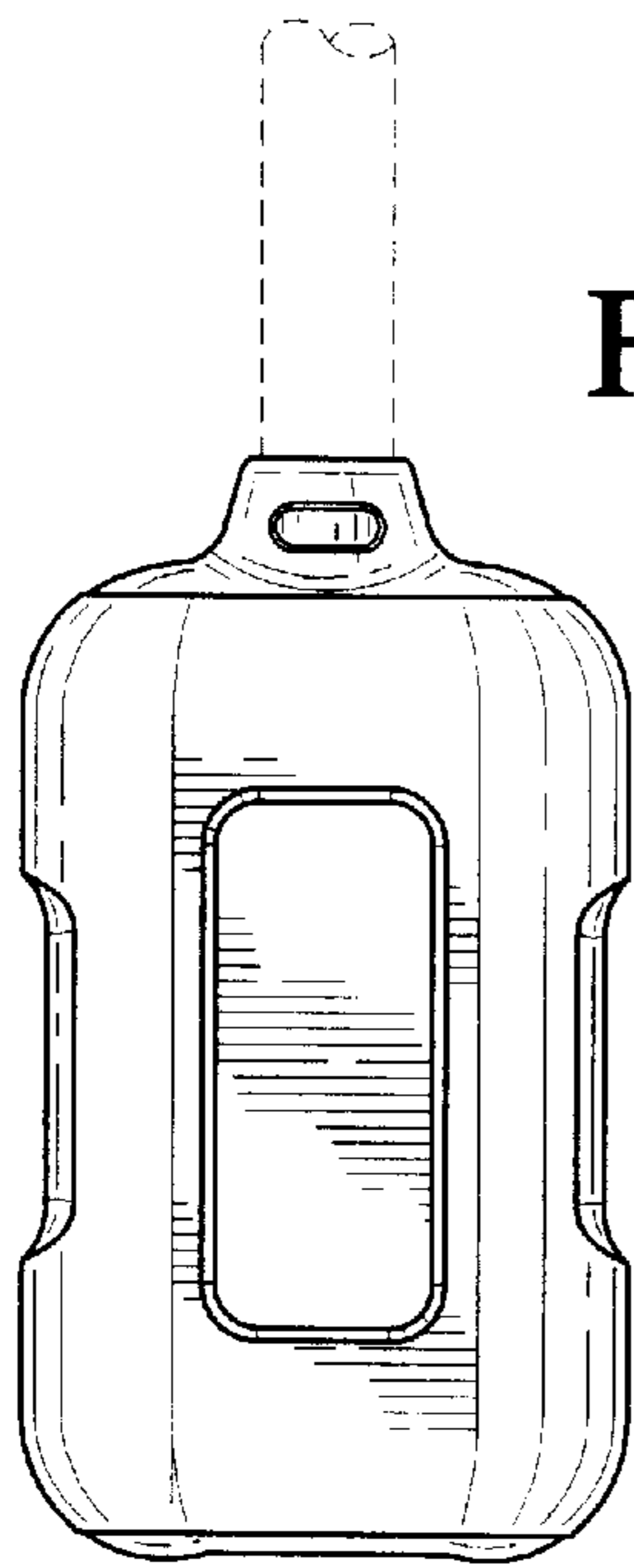

FIG. 1

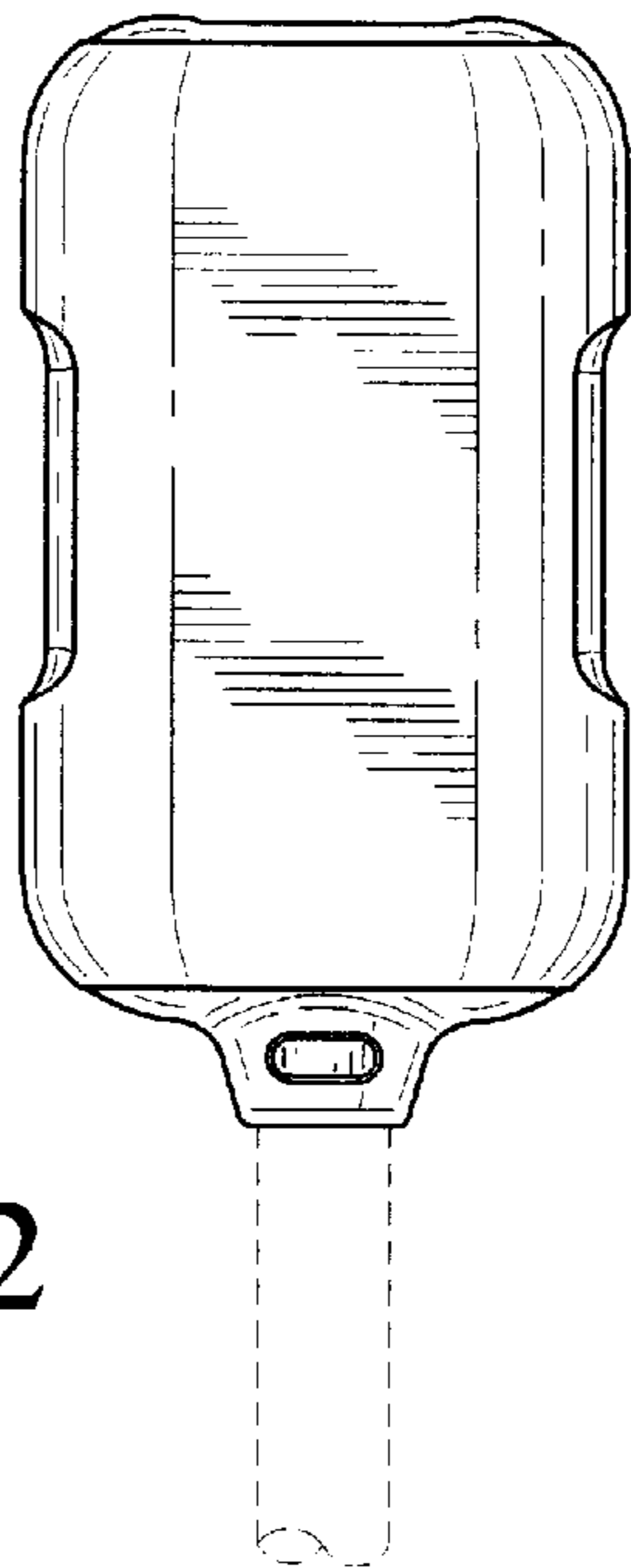

FIG. 2

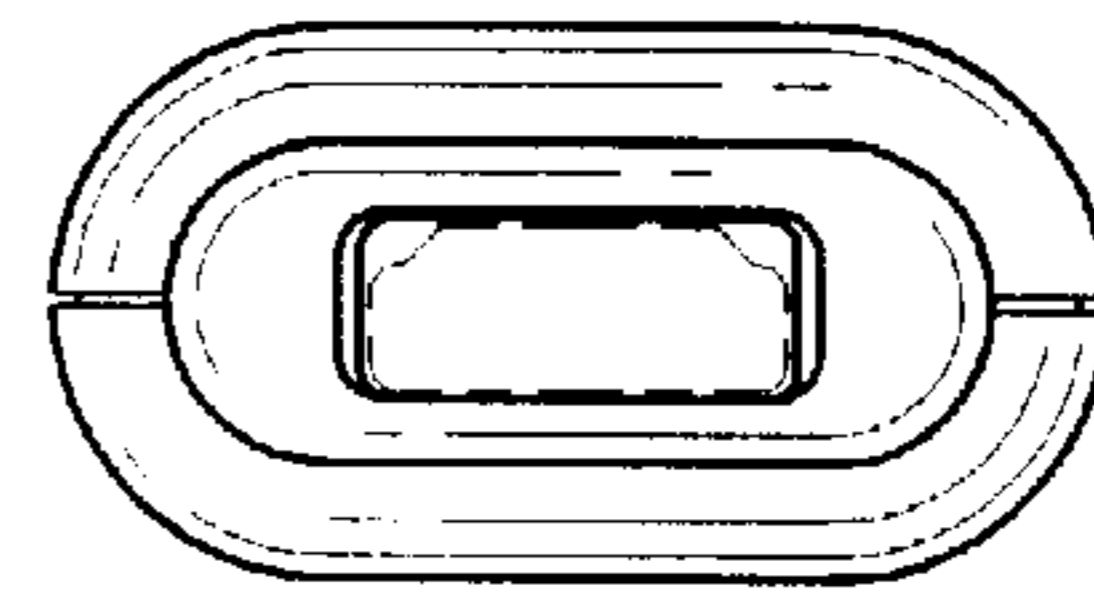

FIG. 3

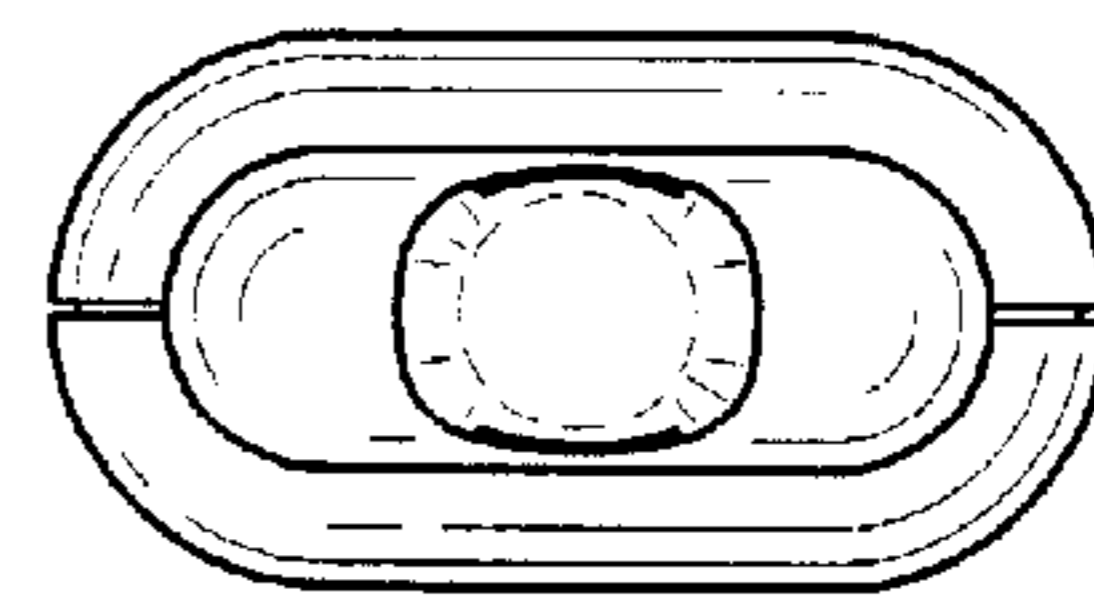

FIG. 4

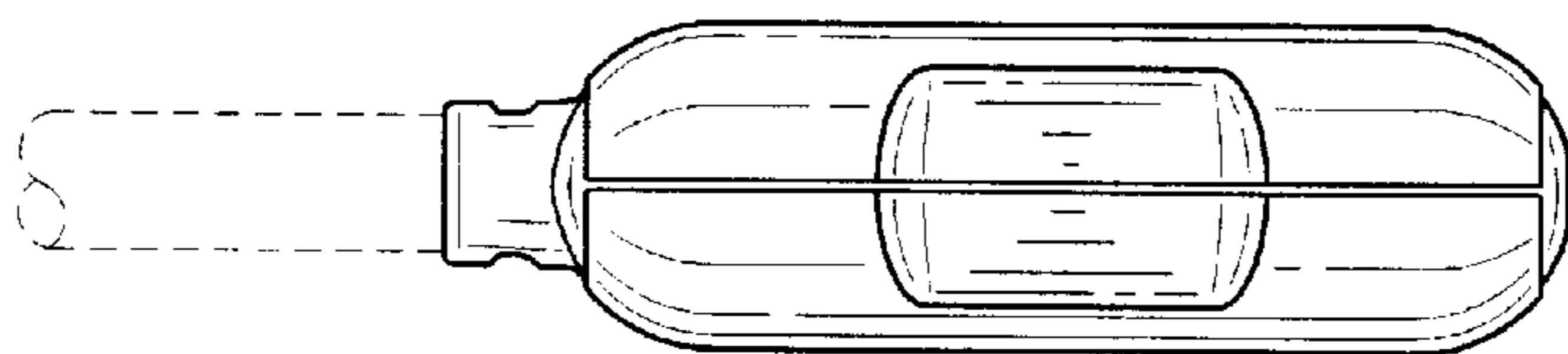

FIG. 5

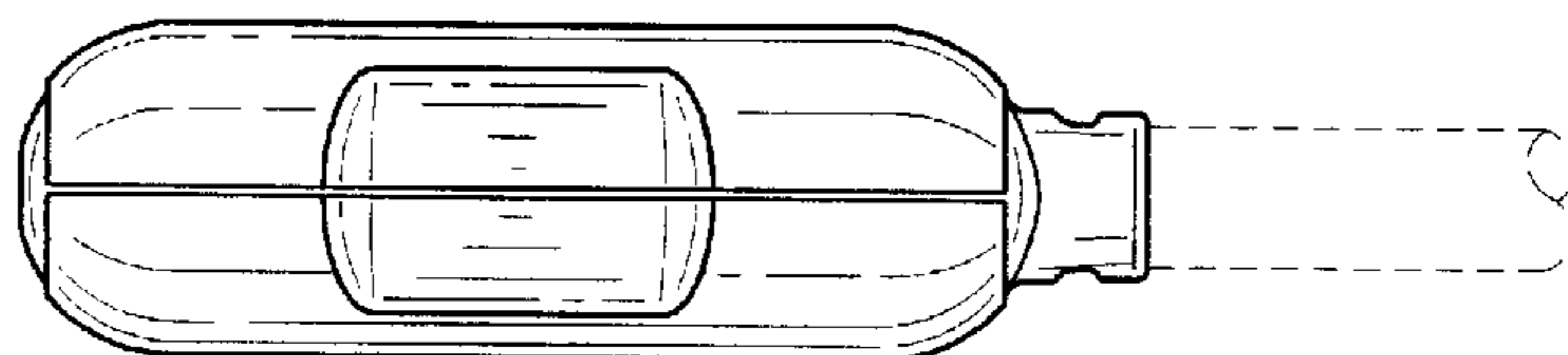

FIG. 6

FIG. 7

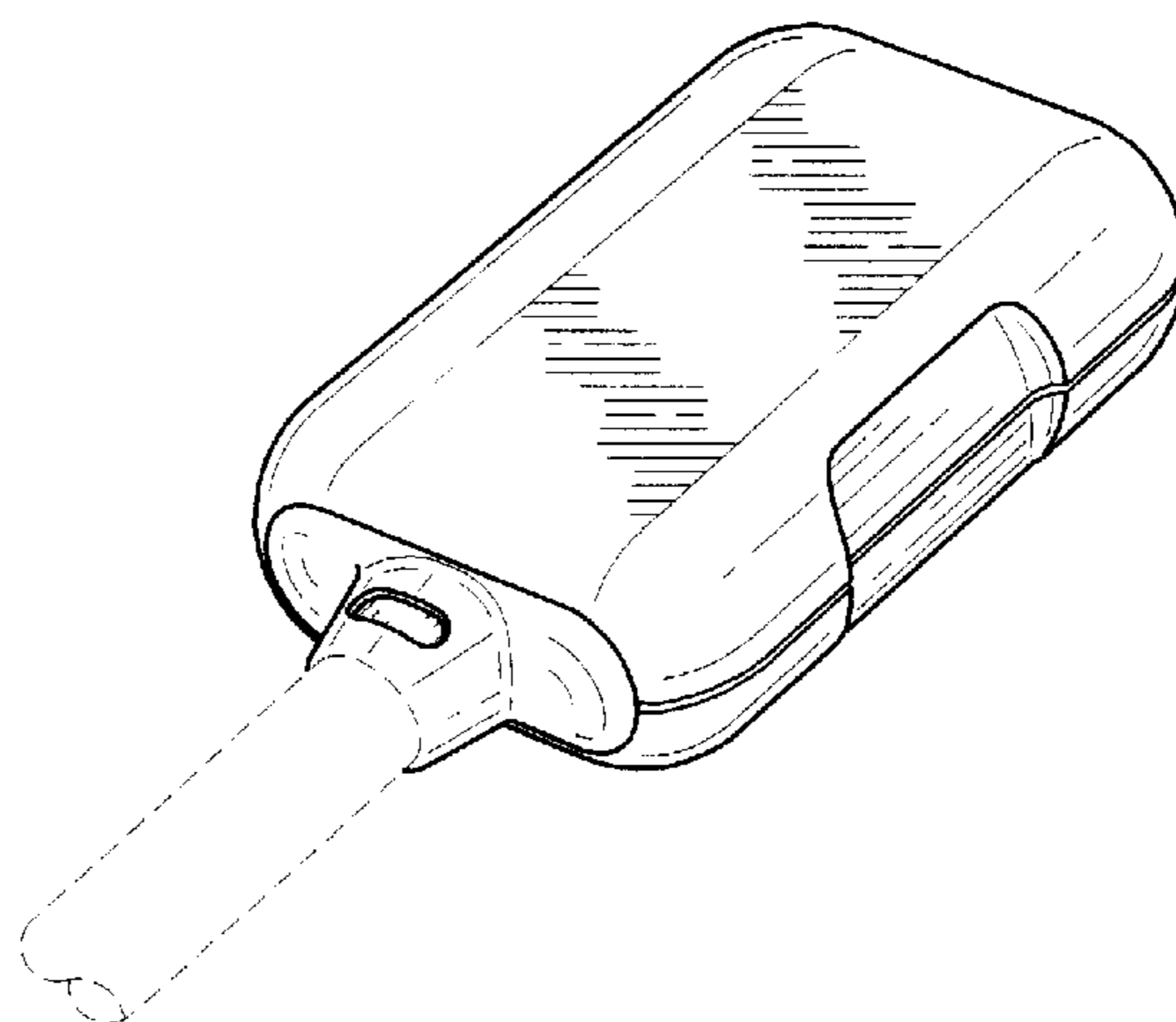
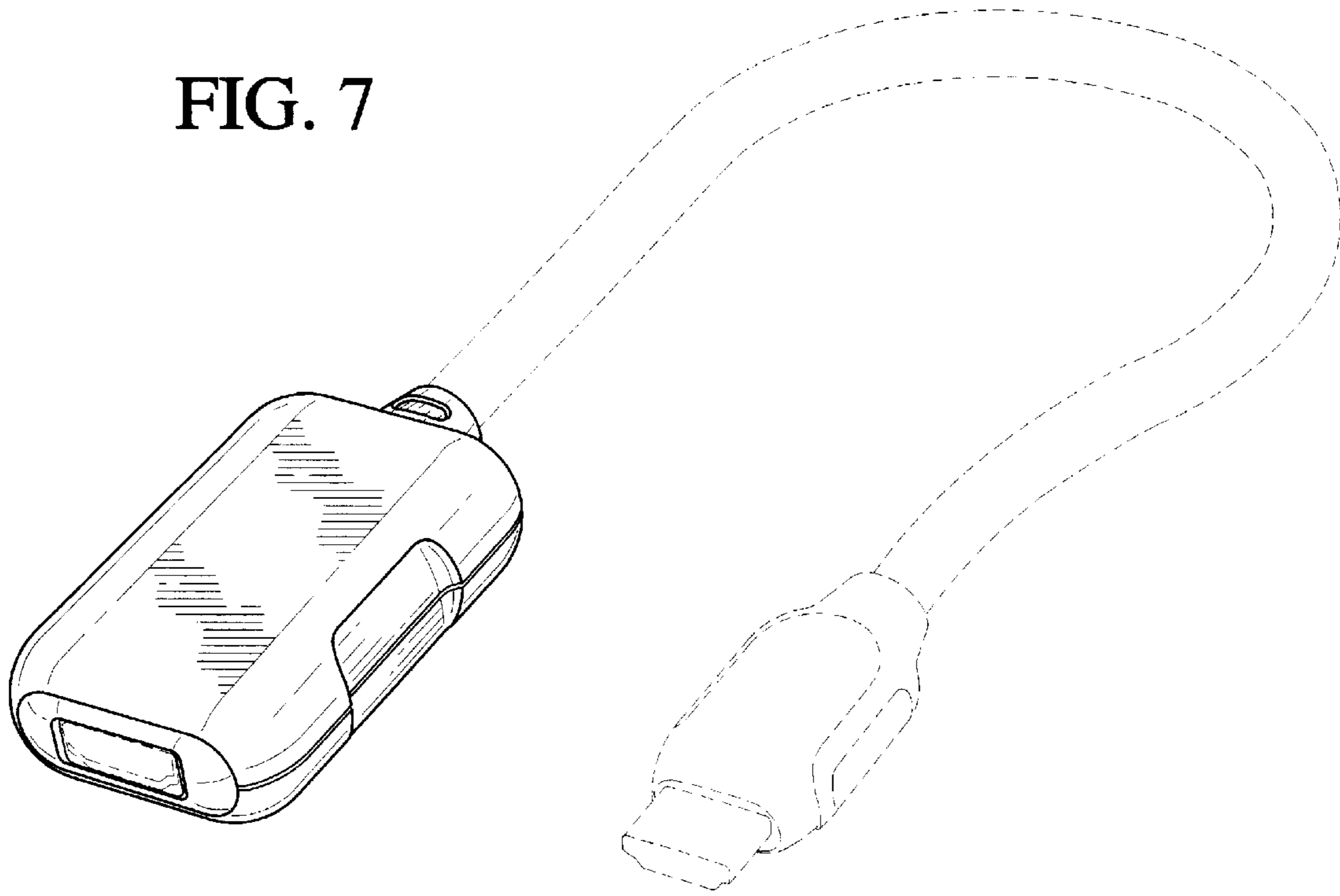

FIG. 8