



US00D537740S

(12) **United States Design Patent**
Grosjean

(10) **Patent No.:** **US D537,740 S**

(45) **Date of Patent:** **** Mar. 6, 2007**

(54) **WATCH**

(75) **Inventor:** **Anne Grosjean, La Chaux-de-Fonds (CH)**

(73) **Assignee:** **Swatch AG (Swatch SA) , (Swatch Ltd.), Bienne (CH)**

(**) **Term:** **14 Years**

(21) **Appl. No.:** **29/199,472**

(22) **Filed:** **Feb. 12, 2004**

(30) **Foreign Application Priority Data**

Oct. 8, 2003 (WO) DM/064 396

(51) **LOC (8) Cl.** **10-02**

(52) **U.S. Cl.** **D10/38**

(58) **Field of Classification Search** D10/30-39,
D10/122-132; 368/276-278, 281-283, 285,
368/228, 232, 223, 28, 294, 295, 308, 319-321,
368/239-242, 82-84, 316, 317
See application file for complete search history.

(56) **References Cited**

U.S. PATENT DOCUMENTS

- D244,916 S * 7/1977 Ueno D10/38
- D250,634 S * 12/1978 Porsche D10/32
- D303,636 S * 9/1989 Ciarfeo et al. D10/39
- D303,937 S * 10/1989 King et al. D10/39
- 5,272,683 A * 12/1993 Jackl 368/282
- 5,297,121 A * 3/1994 Sepehri 368/228
- D356,270 S * 3/1995 Kaneko D10/32
- 5,455,808 A * 10/1995 Grupp et al. 368/82
- 5,473,580 A * 12/1995 Gilomen et al. 368/28
- D368,229 S * 3/1996 Crocco D10/30
- 5,668,781 A * 9/1997 Jeannet et al. 368/28
- 5,696,741 A * 12/1997 Nussbaum 368/281

- D402,565 S * 12/1998 Sato et al. D10/32
- D413,530 S * 9/1999 Flury et al. D10/32
- D413,816 S * 9/1999 Schiavo et al. D10/30
- D451,819 S * 12/2001 Streltsov D10/30
- 6,356,512 B1 * 3/2002 Martin et al. 368/10
- D457,818 S * 5/2002 Avranches D10/39
- 6,540,396 B1 * 4/2003 Barras 368/281
- D476,905 S * 7/2003 El Kadiri D10/30
- D476,906 S * 7/2003 Nussbaum D10/30
- D477,234 S * 7/2003 El Kadiri D10/30
- D477,235 S * 7/2003 El Kadiri D10/30
- 6,672,758 B2 * 1/2004 Ehram et al. 368/190
- 6,714,485 B2 * 3/2004 Albisetti et al. 368/27
- 6,809,993 B1 * 10/2004 Muller et al. 368/242
- D502,409 S * 3/2005 Figueiredo D10/30

OTHER PUBLICATIONS

Uhrmacher Zeitschrift, Mar. 1983, p. 108, Swatch watches.*
Swatch Catalog, Spring-Summer Collection 2000, "Bleu Travail" watch #GK 735.*

* cited by examiner

Primary Examiner—Lucy Lieberman

(74) *Attorney, Agent, or Firm*—Collen IP; Donald J. Ramft

(57) **CLAIM**

The ornamental design for watch, as shown.

DESCRIPTION

FIG. 1 is a front view of the watch;
FIG. 2 is a back view thereof;
FIG. 3 is a right side view thereof;
FIG. 4 is a left side view thereof;
FIG. 5 is a bottom view thereof;
FIG. 6 is a back perspective view thereof; and,
FIG. 7 is a front perspective view thereof.

1 Claim, 7 Drawing Sheets

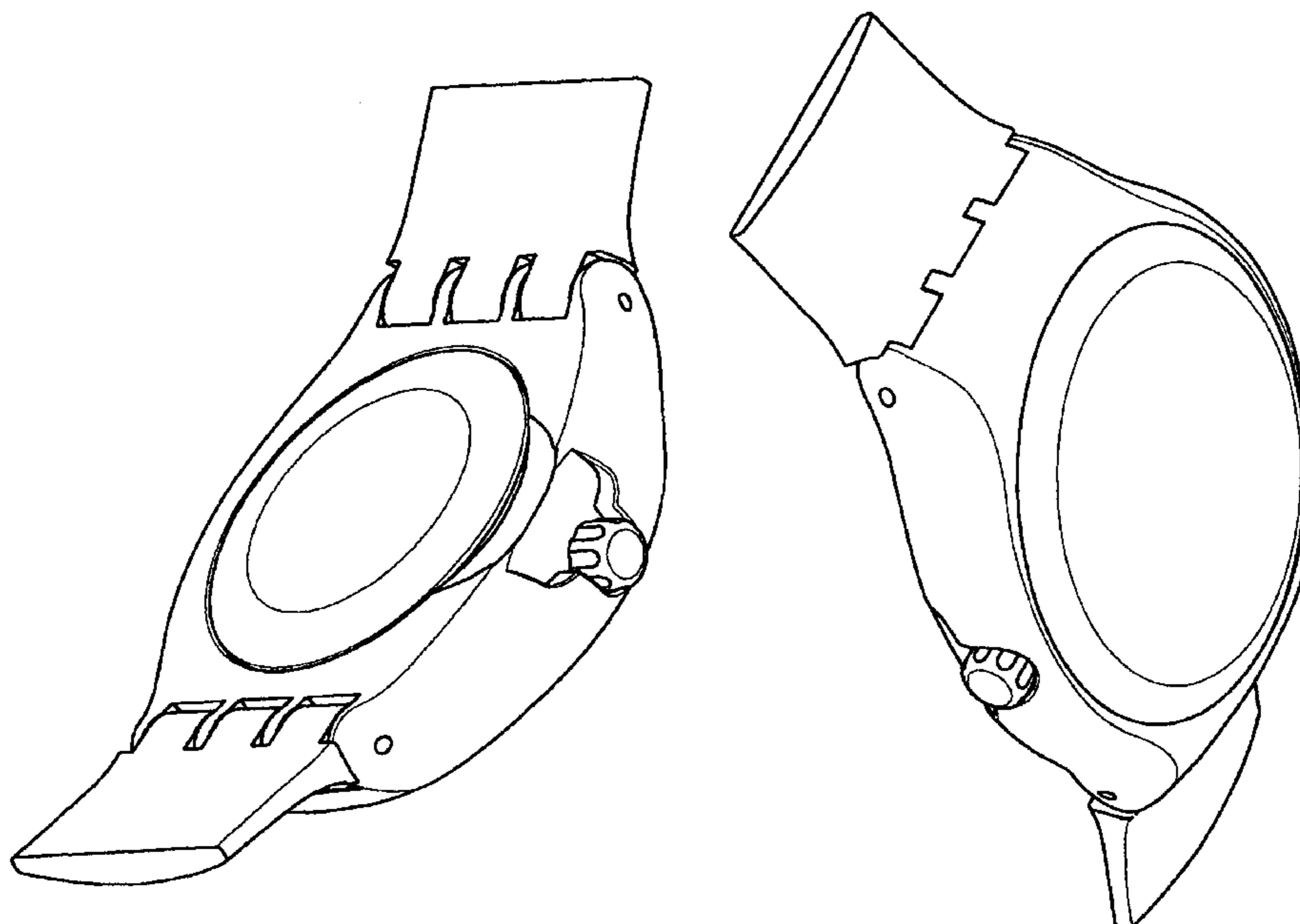

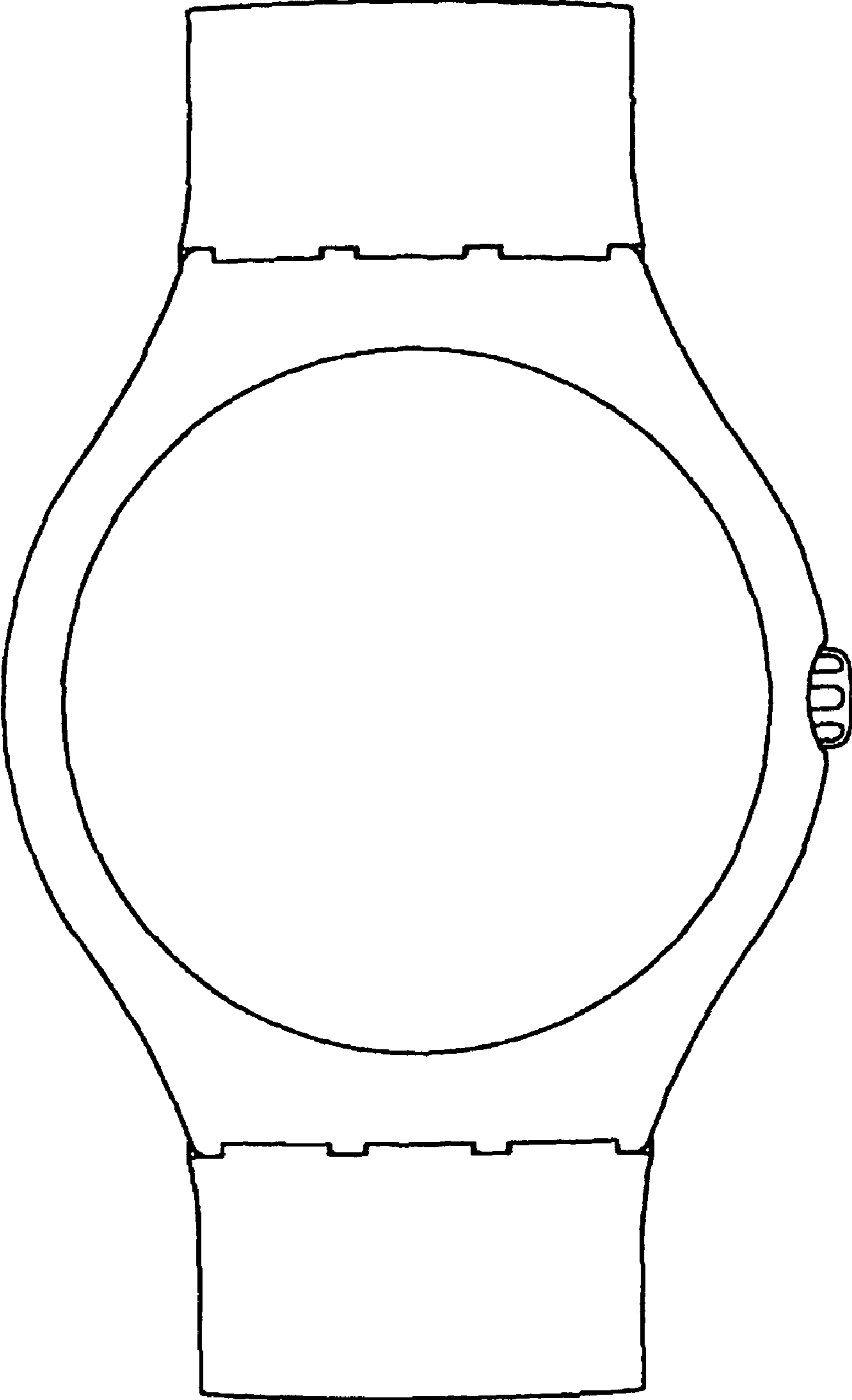

Figure 1

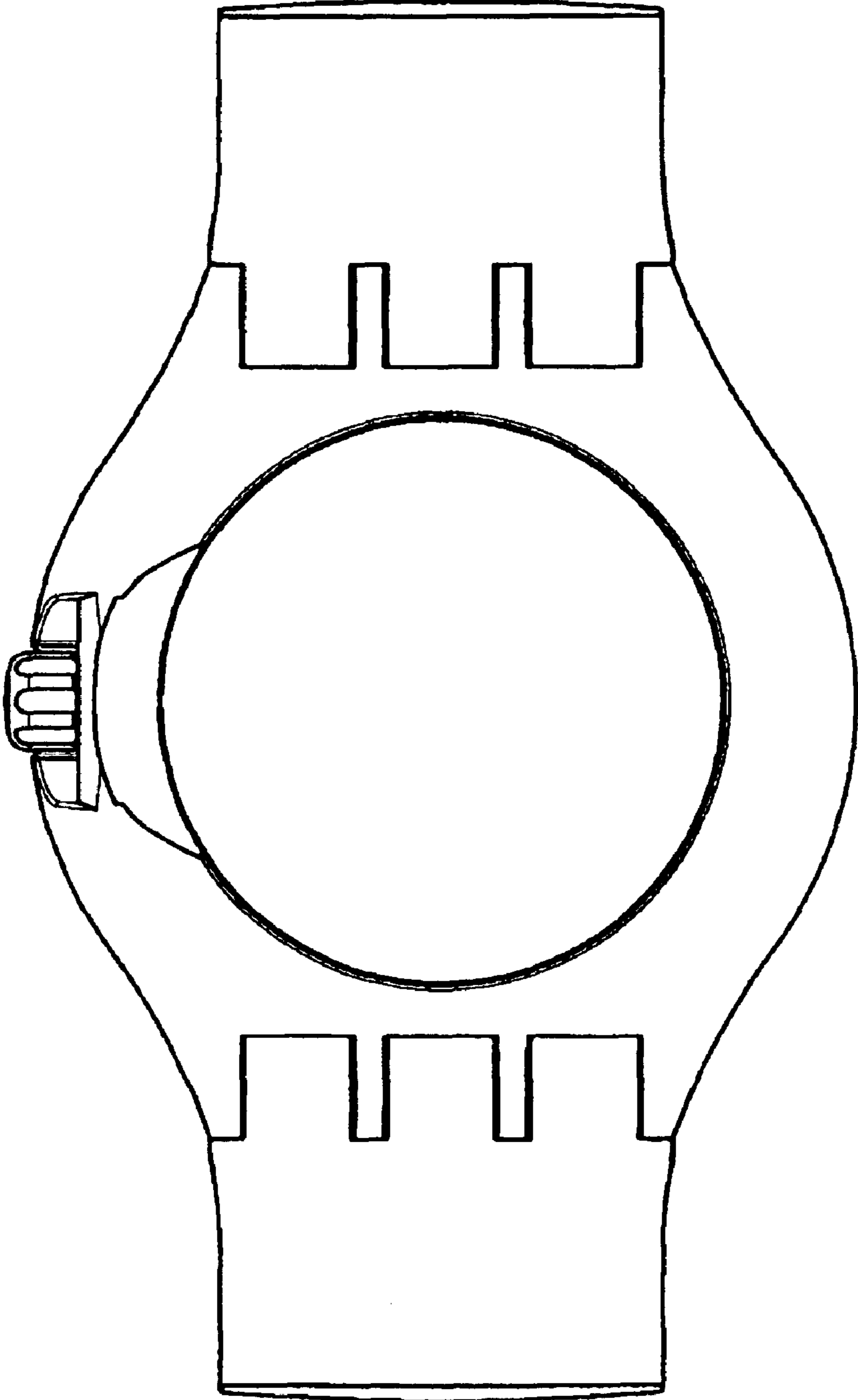

Figure 2

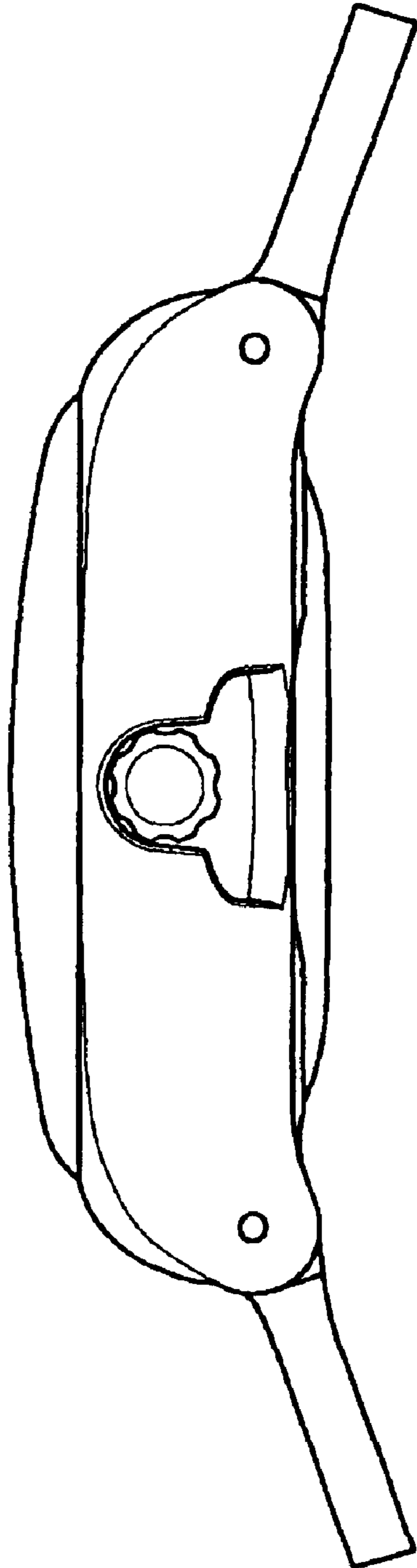

Figure 3

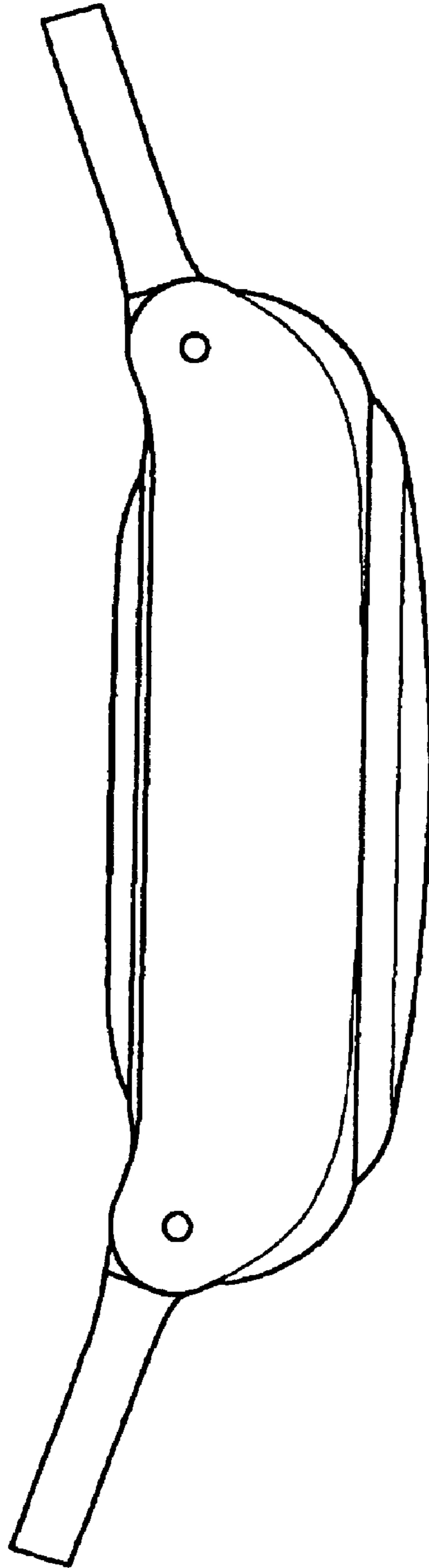

Figure 4

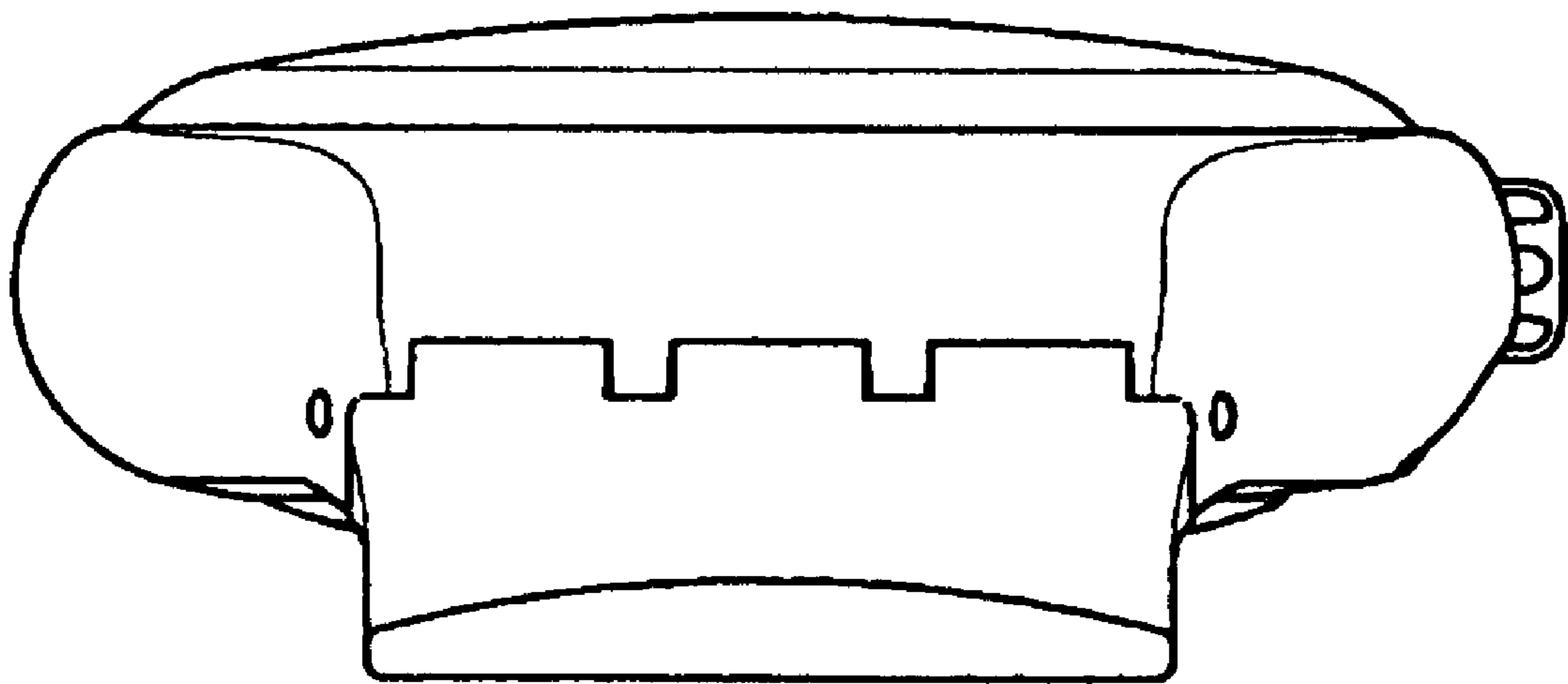

Figure 5

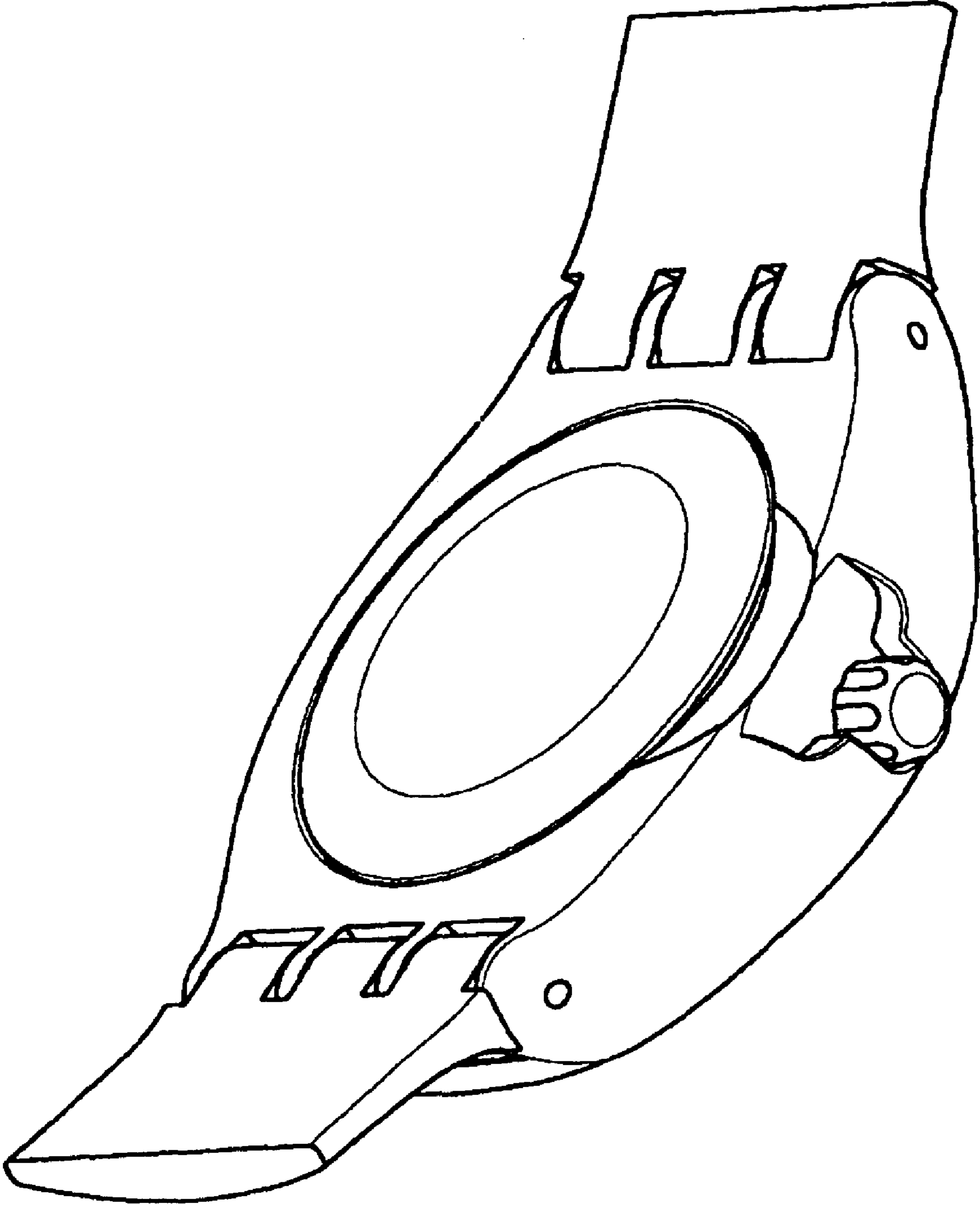

Figure 6

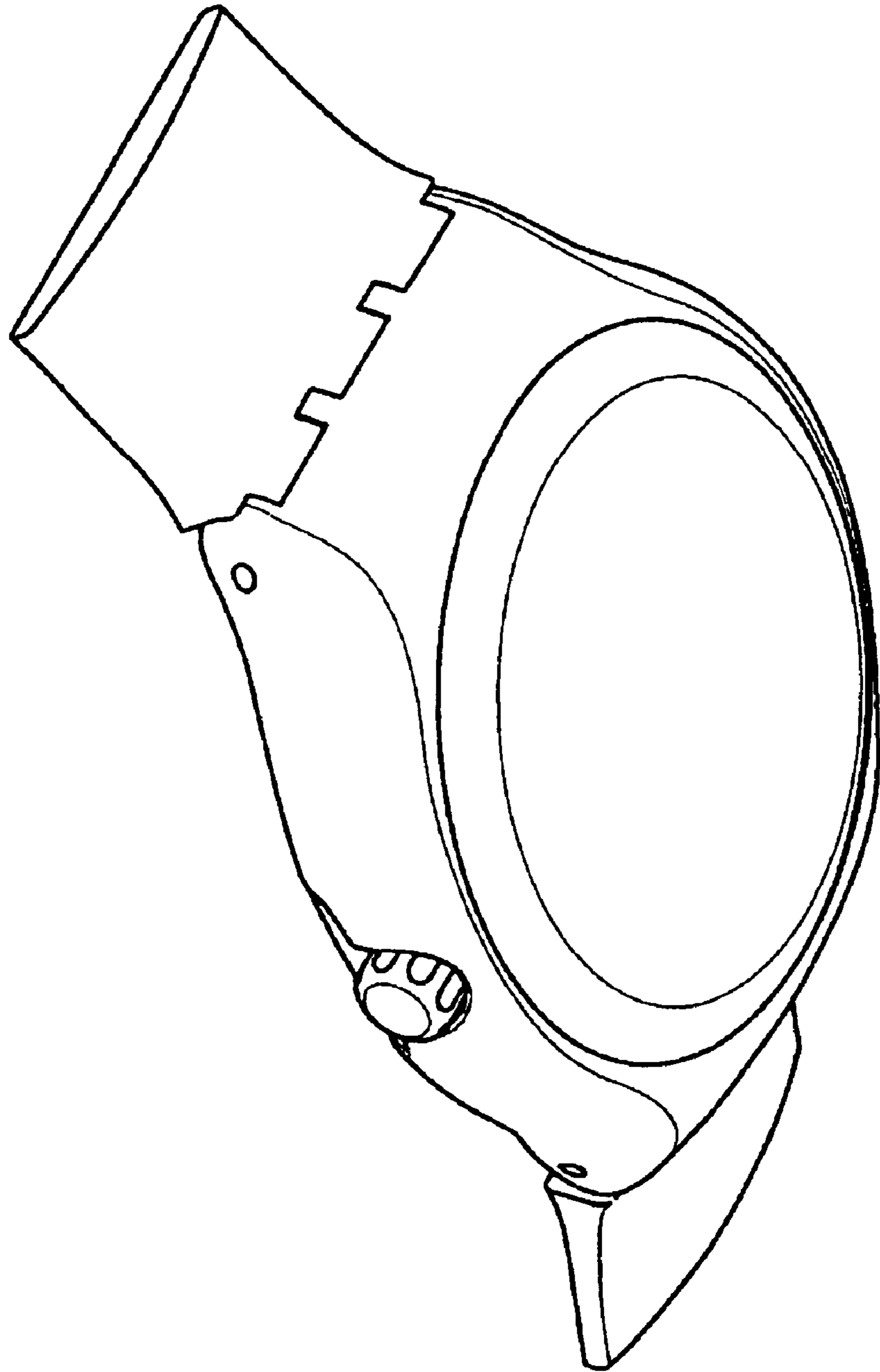

Figure 7