

US00D537646S

(12) **United States Design Patent**
Potter et al.

(10) **Patent No.:** **US D537,646 S**
(45) **Date of Patent:** **** Mar. 6, 2007**

(54) **MESSAGE CHAIR**

(75) Inventors: **David Potter**, Los Angeles, CA (US);
Xu Lifeng, Suzhou (CN)

(73) Assignee: **Interactive Health, LLC.**, Long Beach,
CA (US)

(**) Term: **14 Years**

(21) Appl. No.: **29/255,126**

(22) Filed: **Mar. 3, 2006**

(51) **LOC (8) Cl.** **06-01**

(52) **U.S. Cl.** **D6/367**

(58) **Field of Classification Search** D6/334-336,
D6/360, 361, 367, 371, 373, 379, 492, 500-502;
297/68, 271.1, 271.2, 271.3, 411.45, 423.19,
297/423.3, 353, 354.1, 217.3; 601/49, 57-59,
601/97-99, 102, 115, 116, 148, 149
See application file for complete search history.

(56) **References Cited**

U.S. PATENT DOCUMENTS

D390,018 S	*	2/1998	Lee	D6/334
D430,974 S	*	9/2000	Yang	D6/367
D433,243 S	*	11/2000	Garcia	D6/360
D476,492 S	*	7/2003	Yamamoto et al.	D6/335
D500,212 S	*	12/2004	Potter	D6/367
D500,608 S	*	1/2005	Potter et al.	D6/367
D508,617 S	*	8/2005	Potter	D6/367
D511,900 S	*	11/2005	Inada et al.	D6/367

* cited by examiner

Primary Examiner—Mimosa De

(74) *Attorney, Agent, or Firm*—Christie, Parker & Hale,
LLP.

(57) **CLAIM**

The ornamental design for massage chair, as shown and described.

DESCRIPTION

FIG. 1 is perspective view of a first embodiment a massage chair according to the present invention;

FIG. 2 is a side view of the massage chair according to FIG. 1;

FIG. 3 is a front view of the massage chair according to FIG. 1;

FIG. 4 is another side view of the massage chair according to FIG. 1;

FIG. 5 is a back view of the massage chair according to FIG. 1;

FIG. 6 is a top view of the massage chair according to FIG. 1;

FIG. 7 is a perspective view of a second embodiment of the massage chair according to FIG. 1;

FIG. 8 is a side view of the massage chair according to FIG. 7;

FIG. 9 is a front view of the massage chair according to FIG. 7;

FIG. 10 is another side view of the massage chair according to FIG. 7;

FIG. 11 is a back view of the massage chair according to FIG. 7; and,

FIG. 12 is a top view of the massage chair according to FIG. 7.

The broken lines shown in the drawing are for illustrative purposes only and form no part of the claimed design.

1 Claim, 12 Drawing Sheets

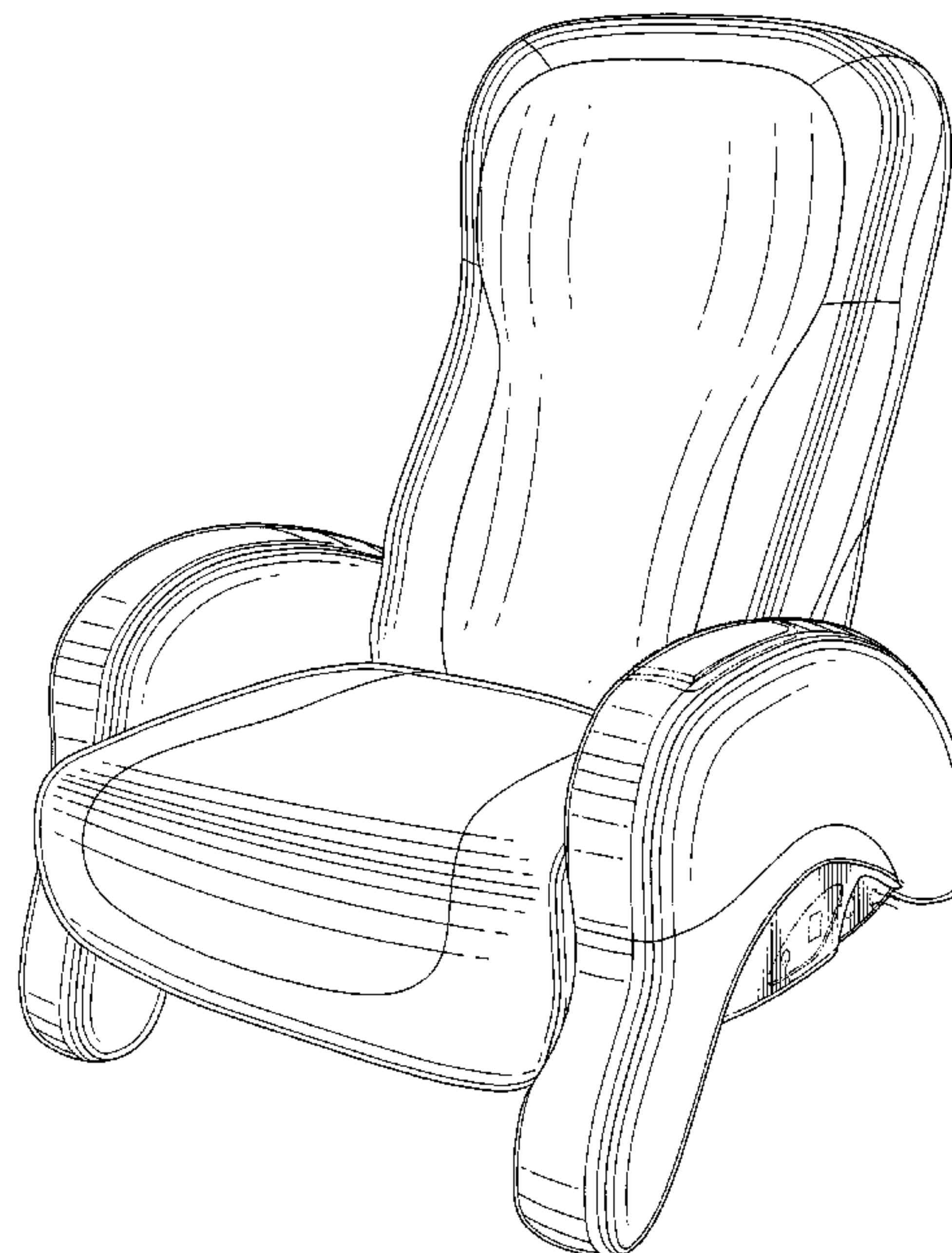
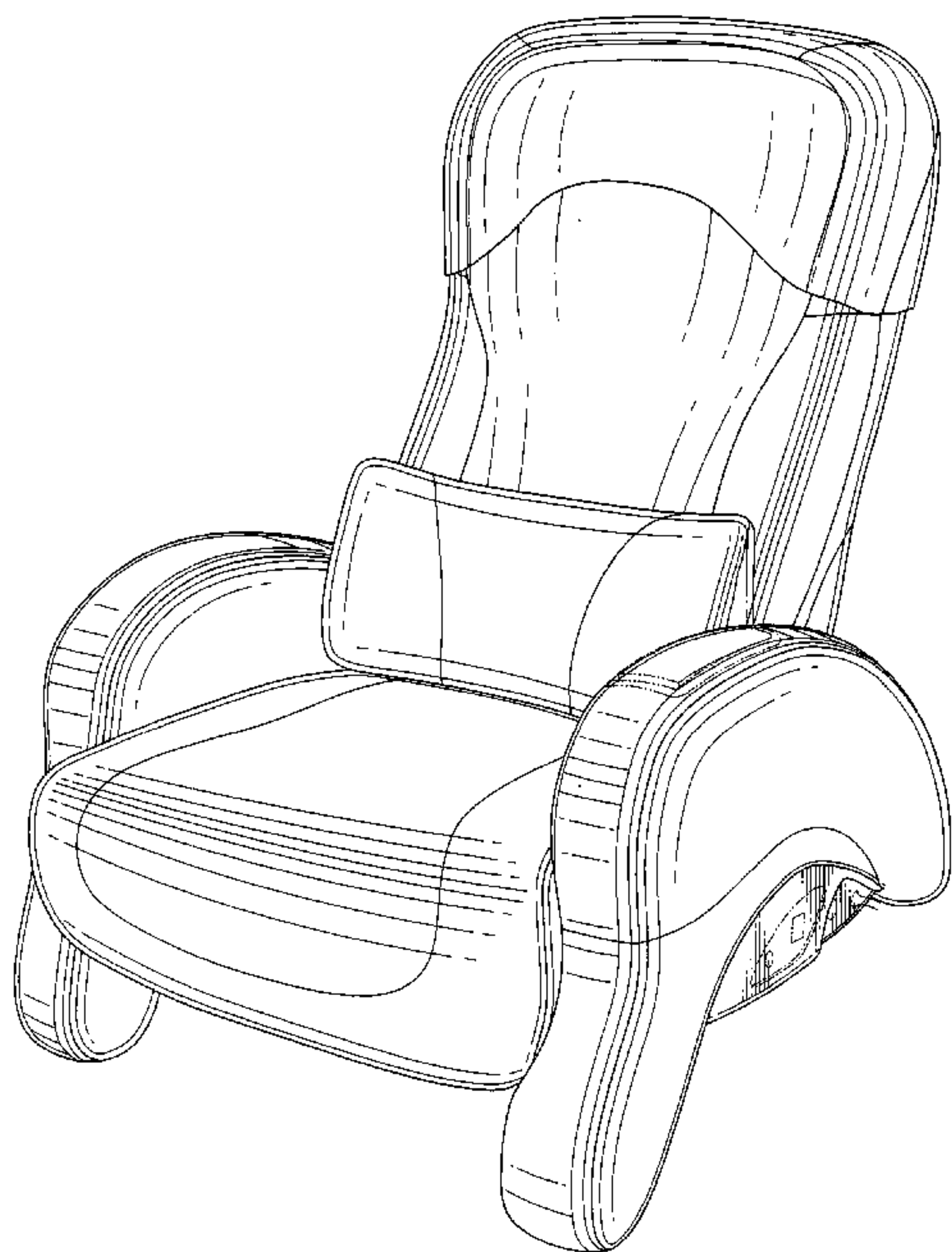

FIG. 1

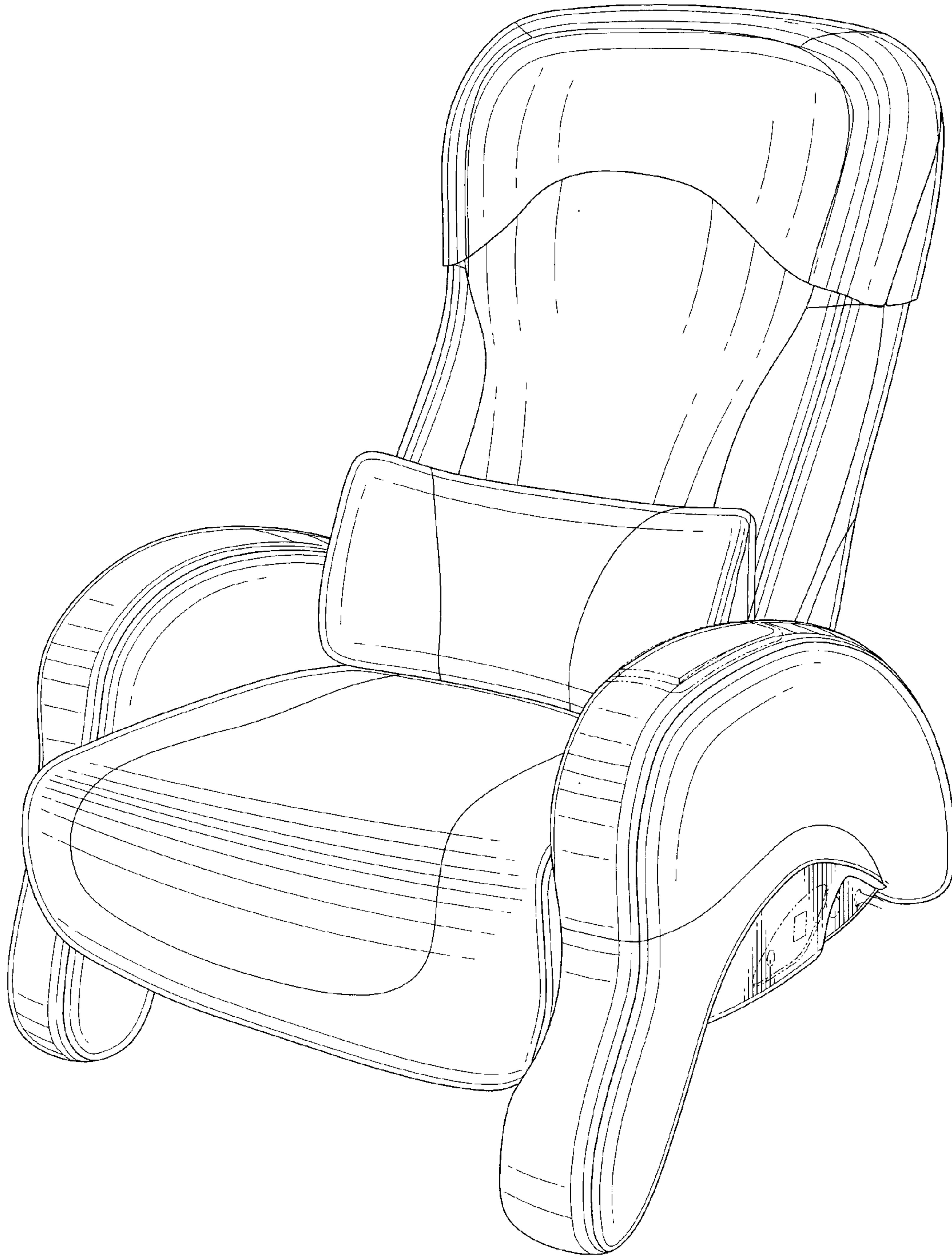

FIG. 2

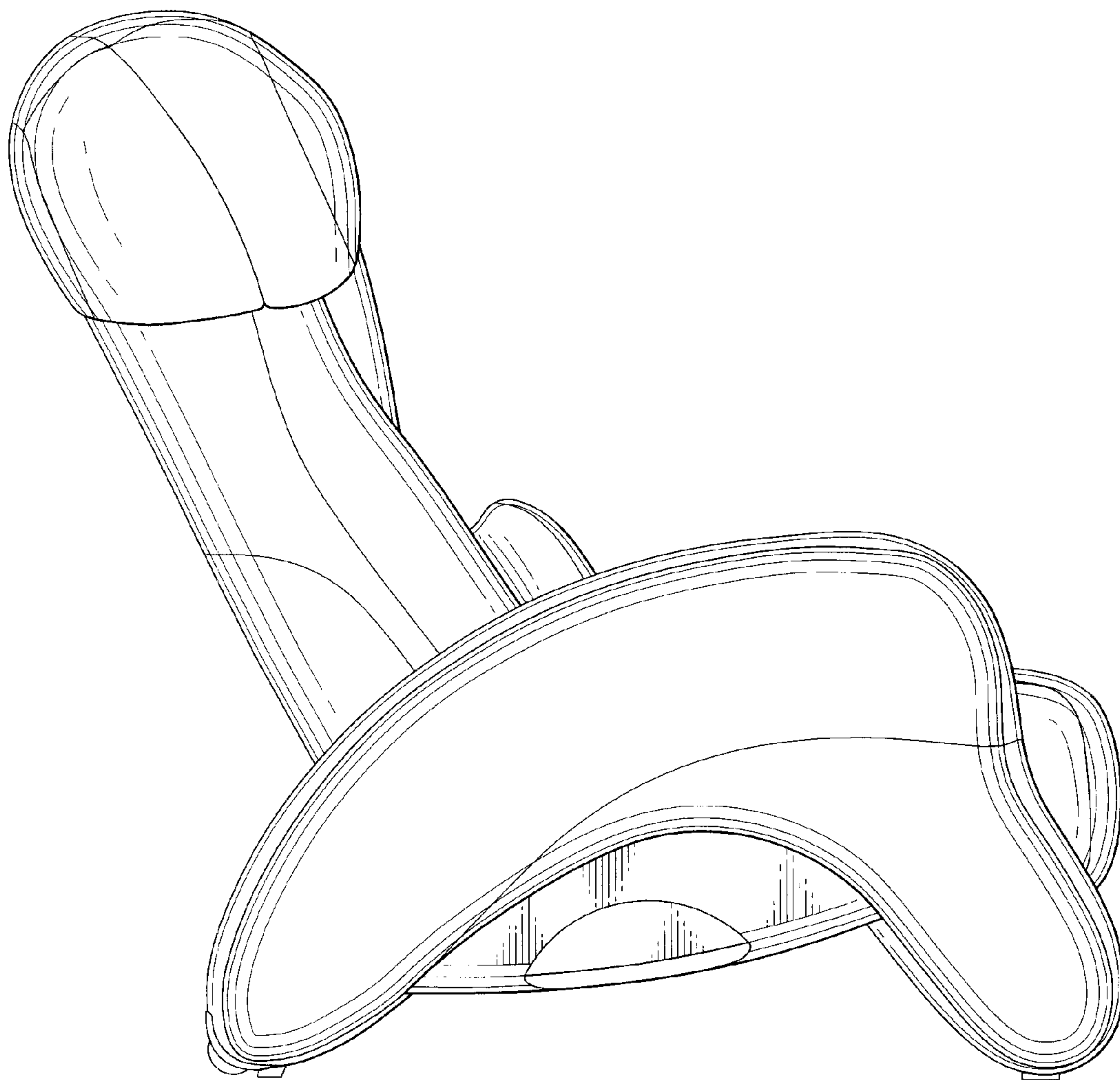

FIG. 3

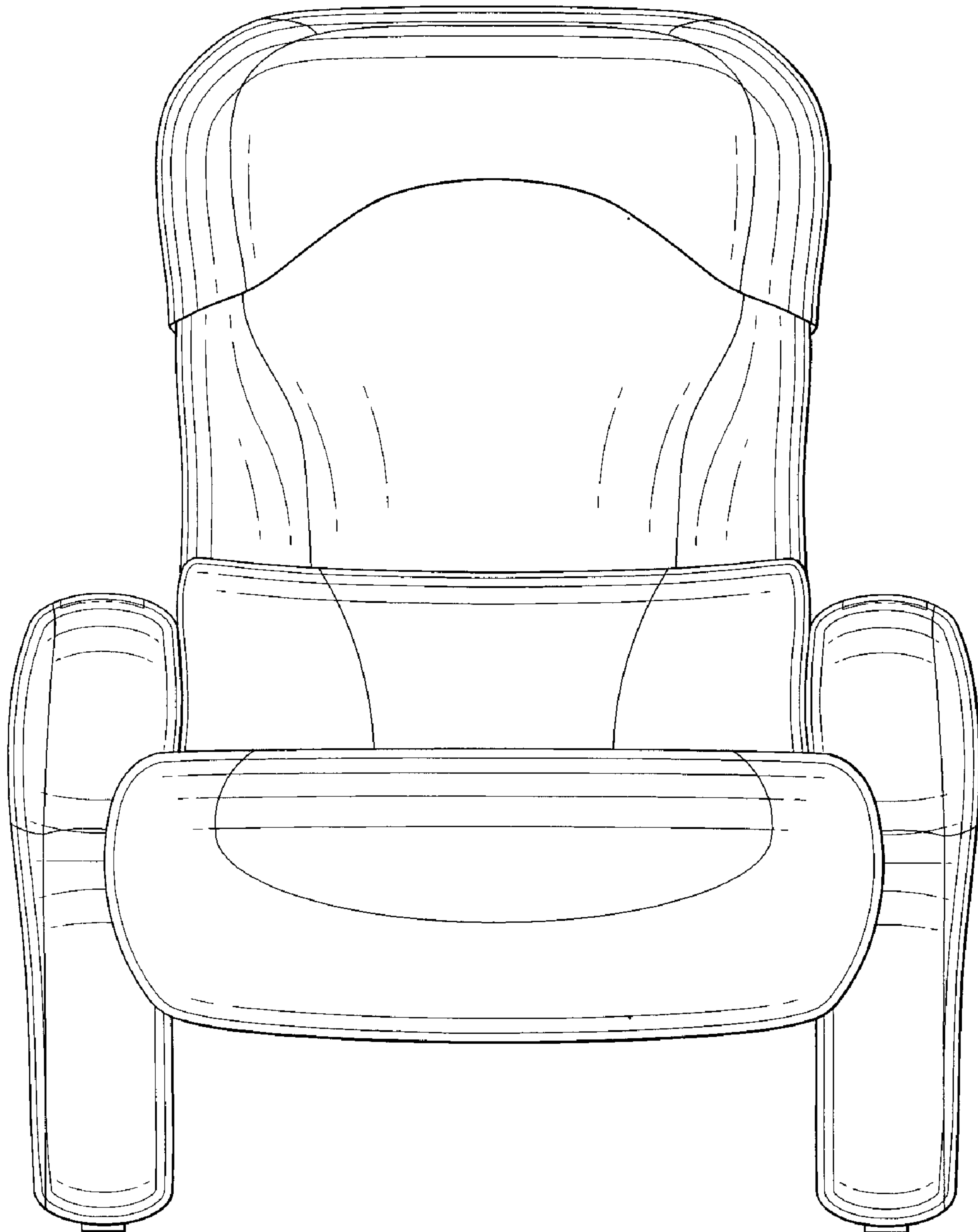

FIG. 4

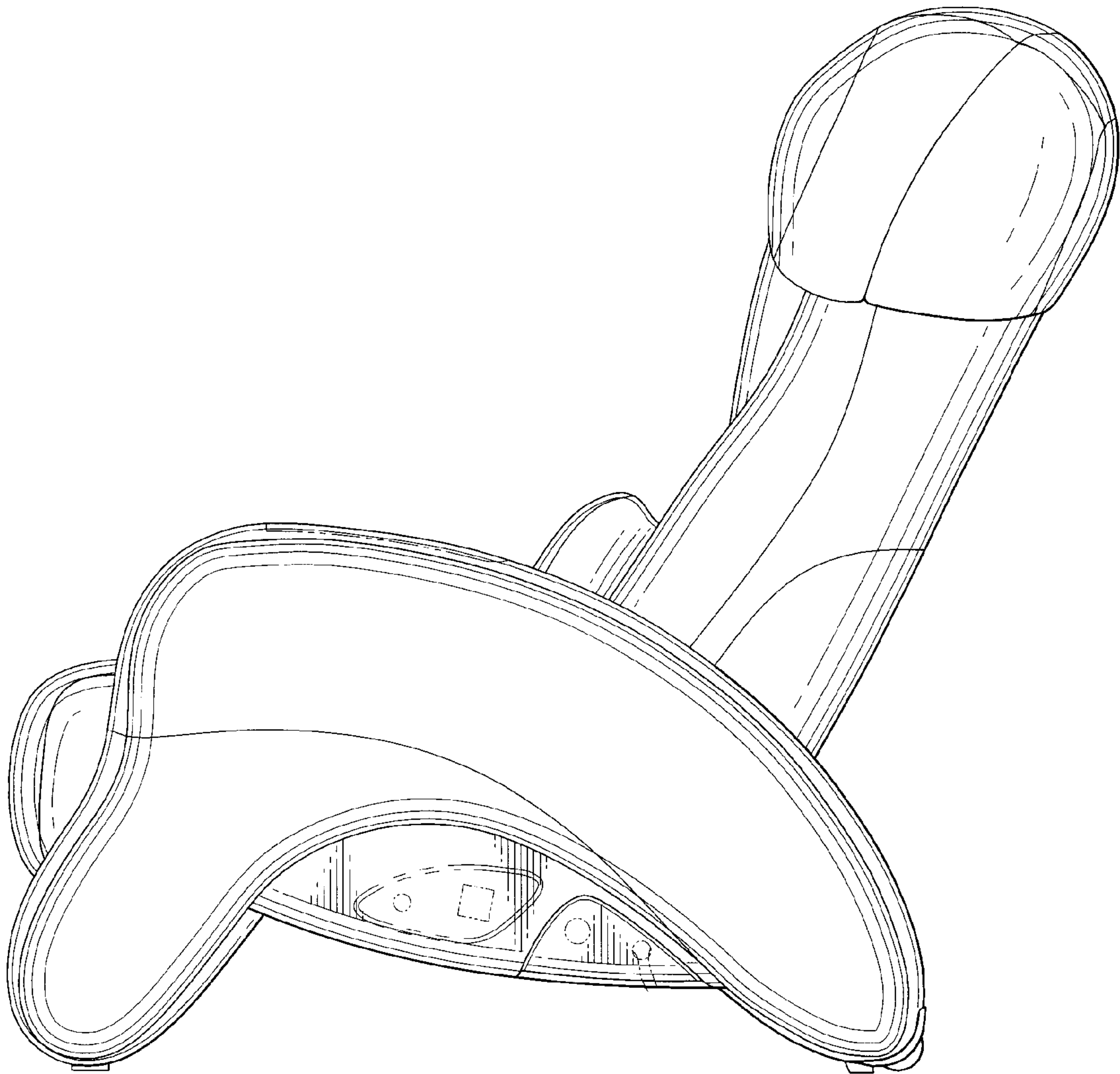

FIG. 5

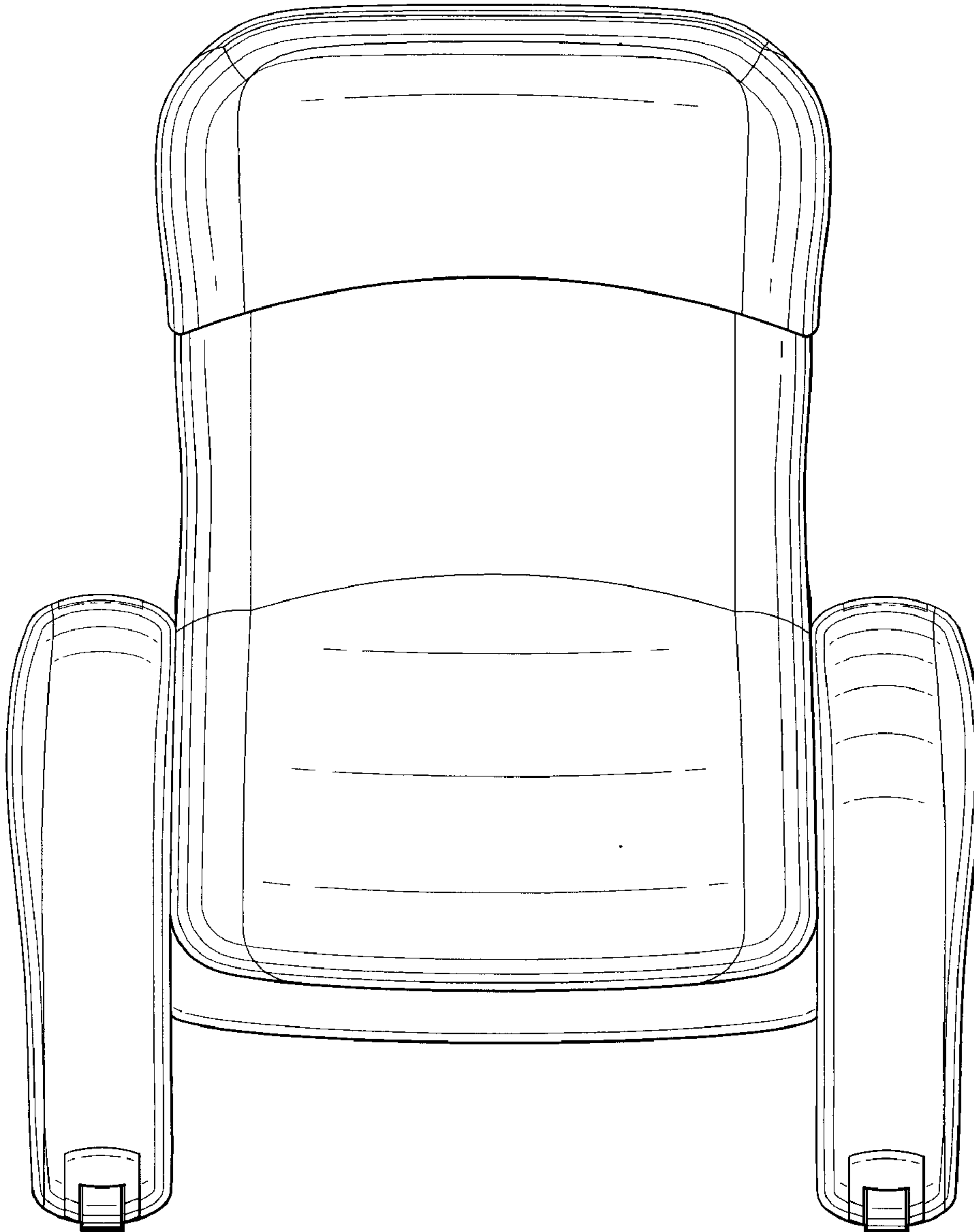

FIG. 6

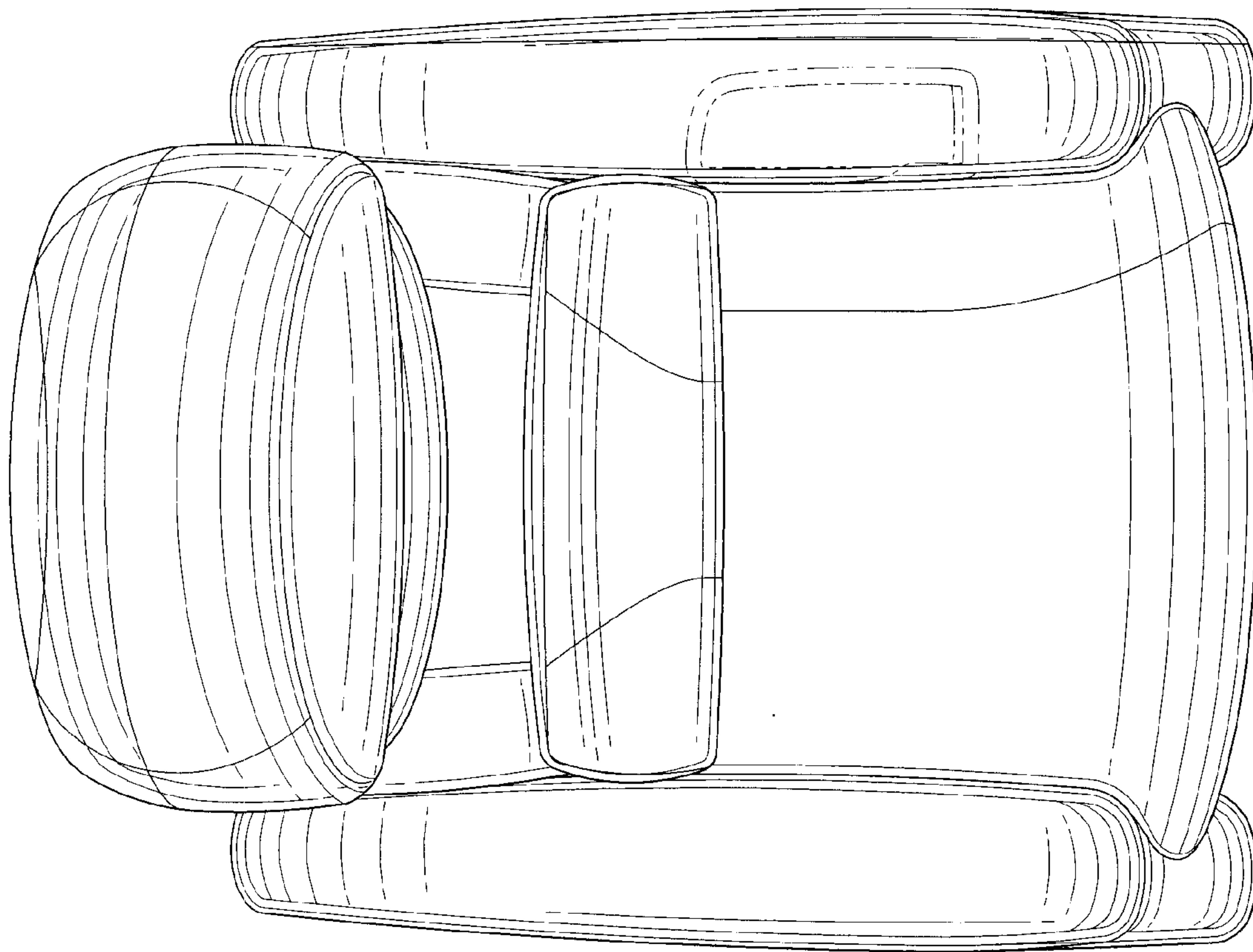

FIG. 7

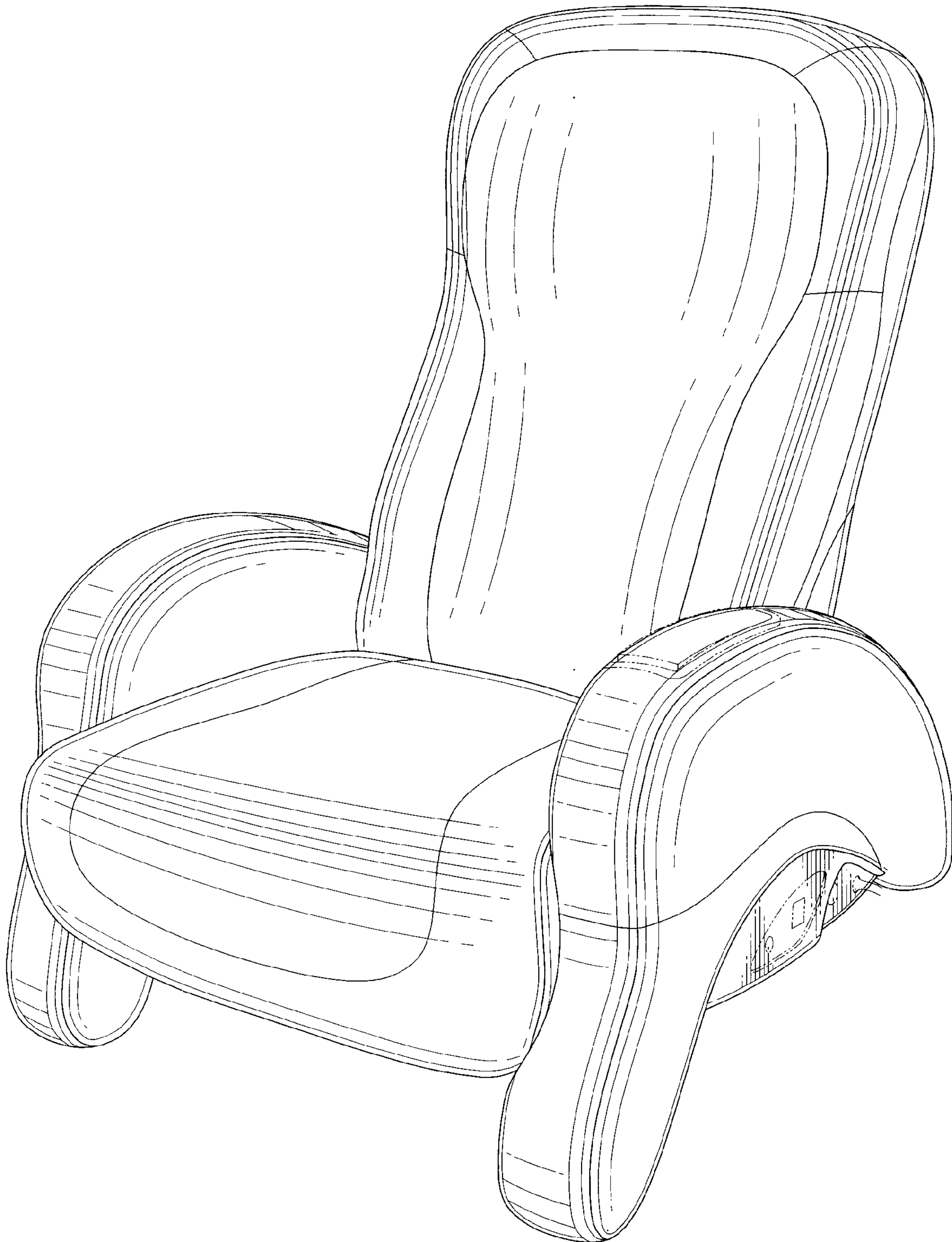

FIG. 8

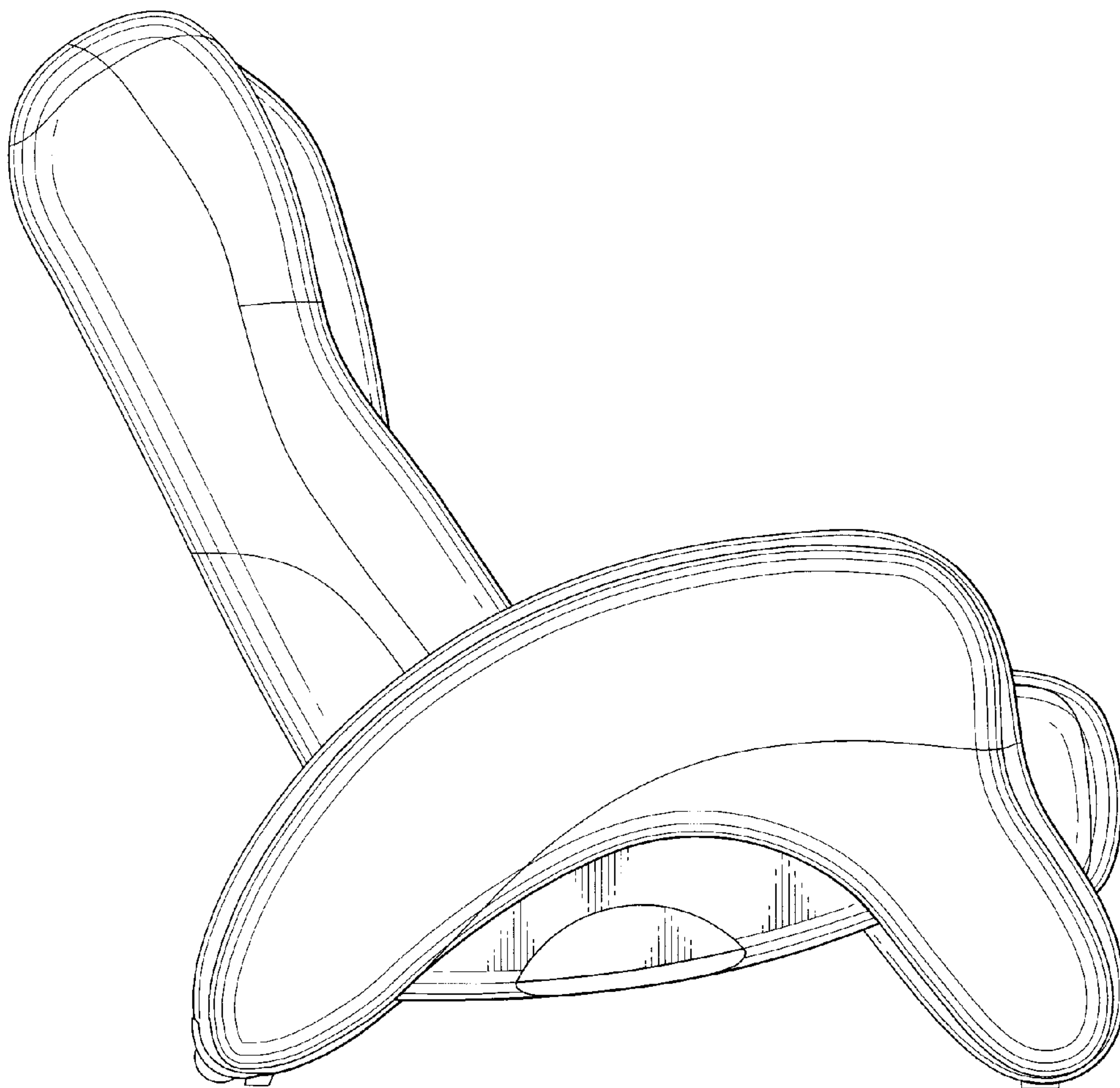

FIG. 9

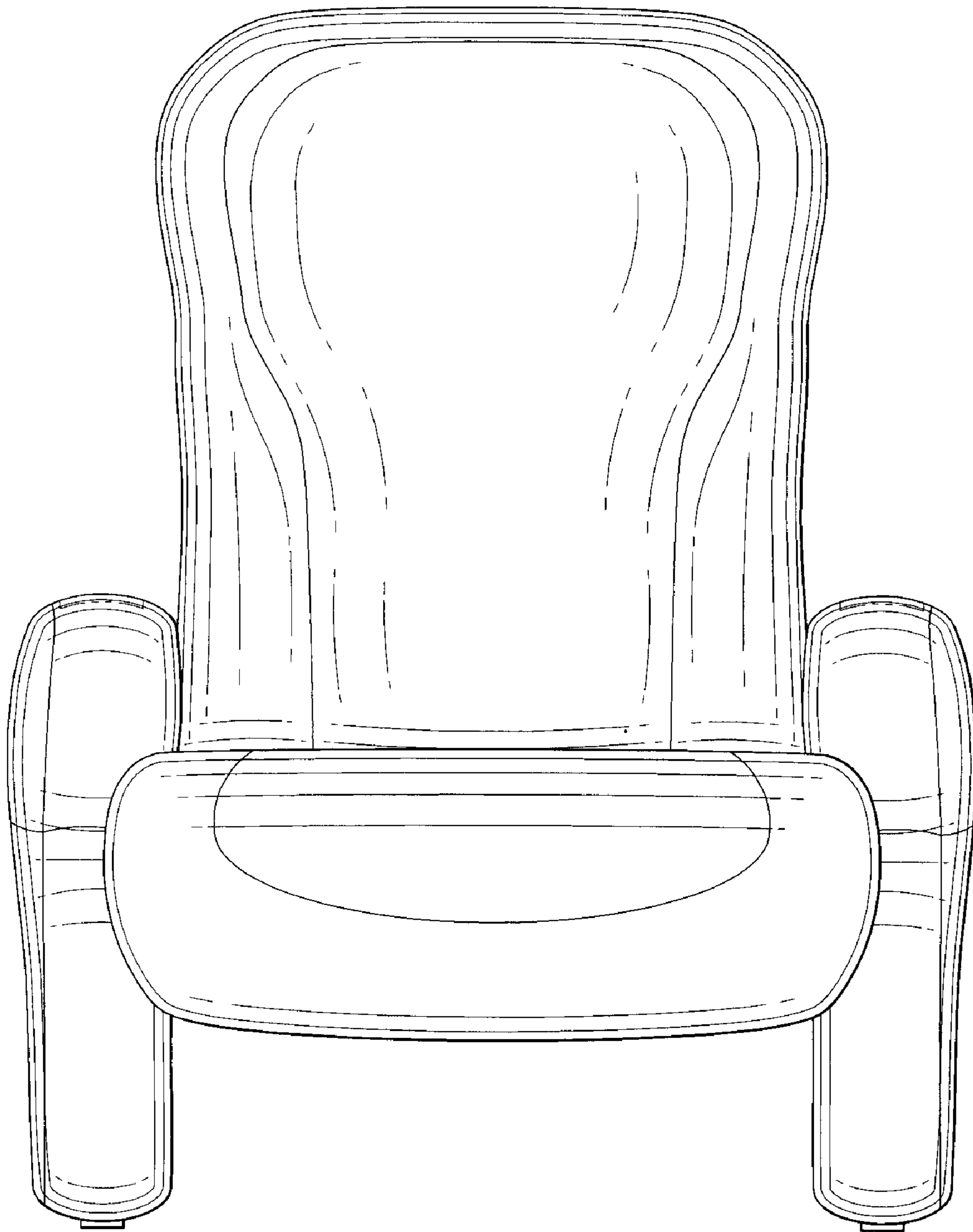

FIG. 10

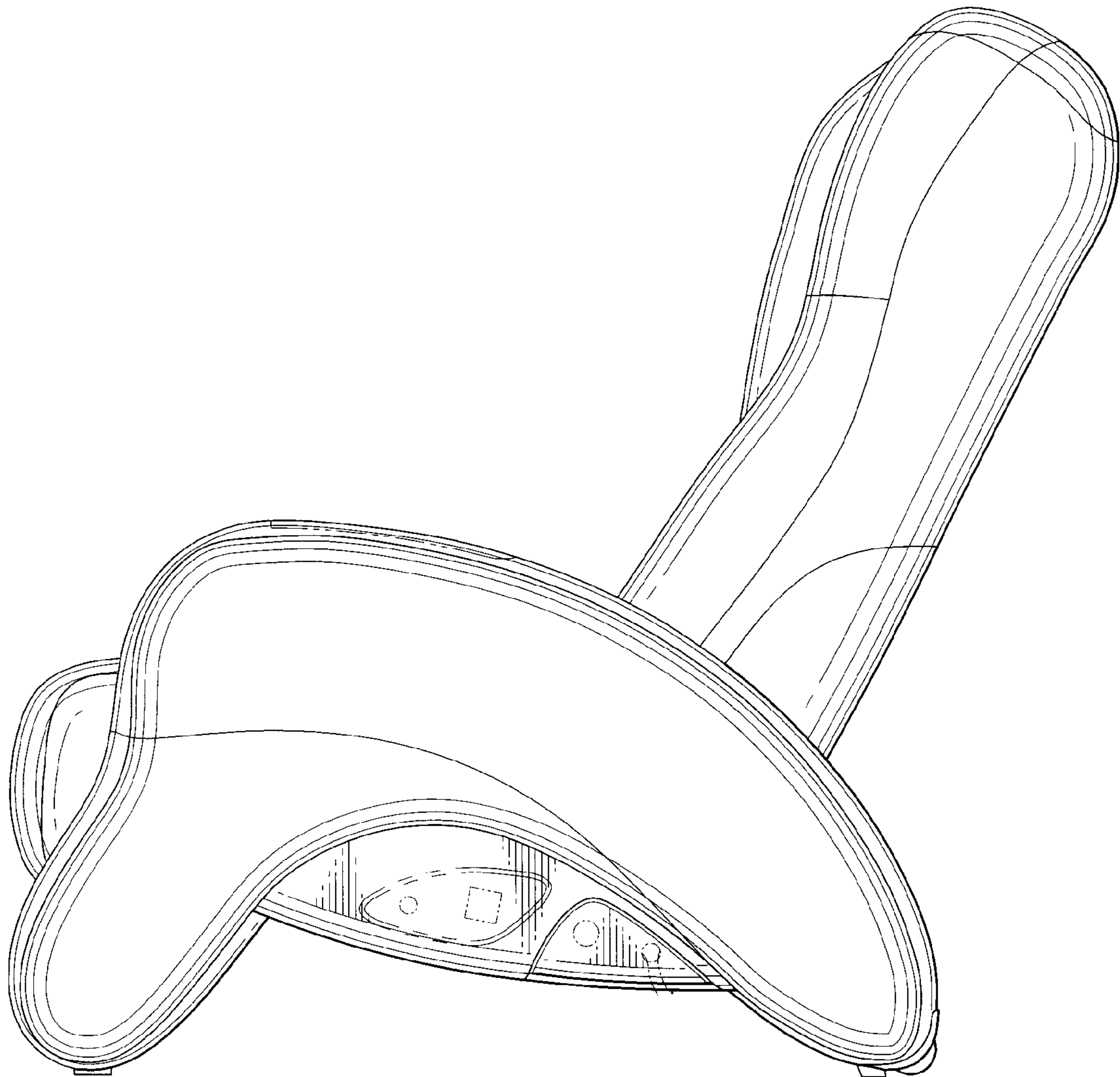

FIG. 11

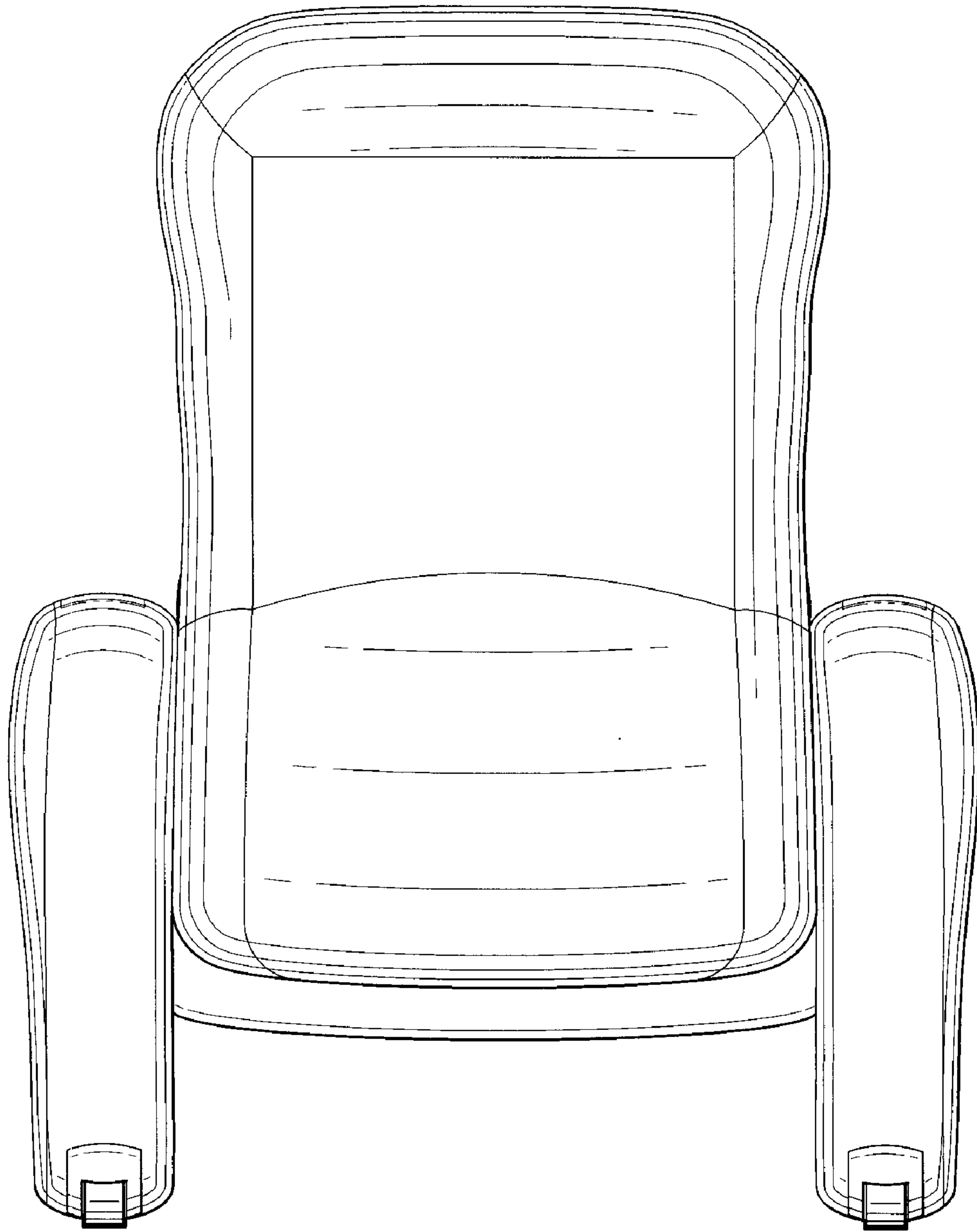

FIG. 12

