



US00D537631S

(12) **United States Design Patent**  
**Kung**

(10) **Patent No.:** **US D537,631 S**

(45) **Date of Patent:** **\*\* Mar. 6, 2007**

(54) **MICROSCOPE CONTAINER**

(75) Inventor: **Su-Min Kung, Shi-Jr (TW)**

(73) Assignee: **Hunter Optical Co., Ltd., Taipei Hsien (TW)**

(\*\*) Term: **14 Years**

(21) Appl. No.: **29/229,841**

(22) Filed: **May 13, 2005**

(30) **Foreign Application Priority Data**

Jan. 11, 2005 (TW) ..... 94300155

(51) **LOC (8) Cl.** ..... **03-01**

(52) **U.S. Cl.** ..... **D3/276; D3/294**

(58) **Field of Classification Search** ..... D3/201,  
D3/203.1–203.2, 203.6–203.8, 273–274,  
D3/276, 282, 292, 294, 905; 190/100, 110,  
190/115; 206/5, 5.1, 6, 828

See application file for complete search history.

(56) **References Cited**

**U.S. PATENT DOCUMENTS**

D94,457 S	*	1/1935	Williamson	.....	D3/263
D202,602 S	*	10/1965	Armbruster	.....	D3/263
D211,440 S	*	6/1968	Maier	.....	D3/263
D347,731 S	*	6/1994	Hayakawa et al.	.....	D3/282
D355,826 S	*	2/1995	Chow	.....	D3/315
D362,546 S	*	9/1995	Mundorf et al.	.....	D3/276
D370,557 S	*	6/1996	Ferris et al.	.....	D3/205
D390,357 S	*	2/1998	Rosen	.....	D3/282
D408,625 S	*	4/1999	Barker	.....	D3/203.1

D428,699 S	*	8/2000	Gibson et al.	.....	D3/282
D434,562 S	*	12/2000	Huang	.....	D3/282
D439,408 S	*	3/2001	Gibson et al.	.....	D3/282
D466,296 S	*	12/2002	Hellenberg-Hubar	.....	D3/295
D467,077 S	*	12/2002	Nawrozki et al.	.....	D3/282
D472,389 S	*	4/2003	Vasudeva	.....	D3/315
D473,713 S	*	4/2003	Chen	.....	D3/282
D474,599 S	*	5/2003	Shamoon	.....	D3/282
D478,725 S	*	8/2003	Vasudeva et al.	.....	D3/282
D483,180 S	*	12/2003	Chen	.....	D3/282
D495,488 S	*	9/2004	Singh	.....	D3/282
D505,543 S	*	5/2005	Miller	.....	D3/203.6
D508,773 S	*	8/2005	Singh	.....	D3/282
D509,958 S	*	9/2005	Singh	.....	D3/282
2005/0236290 A1	*	10/2005	Ohi	.....	206/373

\* cited by examiner

*Primary Examiner*—Philip S. Hyder

*Assistant Examiner*—RoseLynne (Ulm) Cody

(74) *Attorney, Agent, or Firm*—Troxell Law Office, PLLC

(57) **CLAIM**

The ornamental design for a microscope container, as shown and described.

**DESCRIPTION**

FIG. 1 is a perspective view thereof;  
FIG. 2 is a front view thereof;  
FIG. 3 is a back view thereof;  
FIG. 4 is a left side view thereof;  
FIG. 5 is a right side view thereof;  
FIG. 6 is a top view thereof; and,  
FIG. 7 is a bottom view thereof.

**1 Claim, 7 Drawing Sheets**

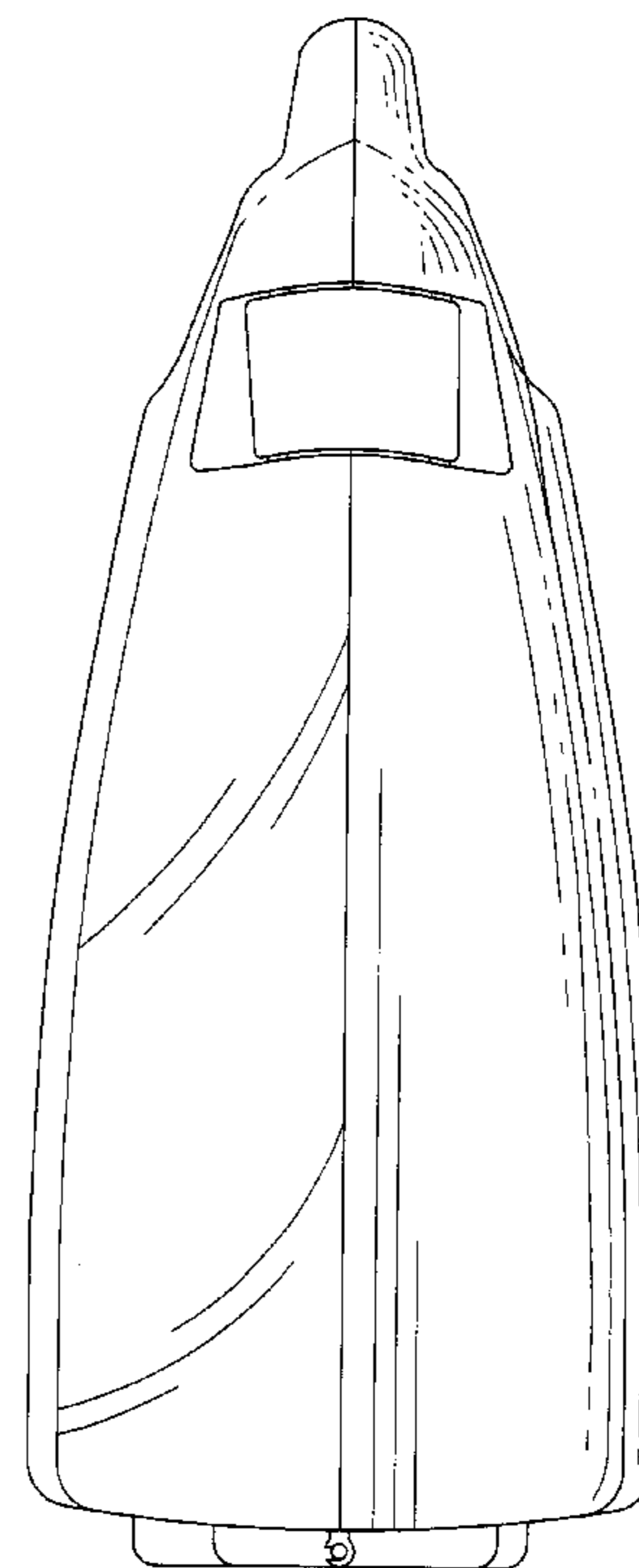
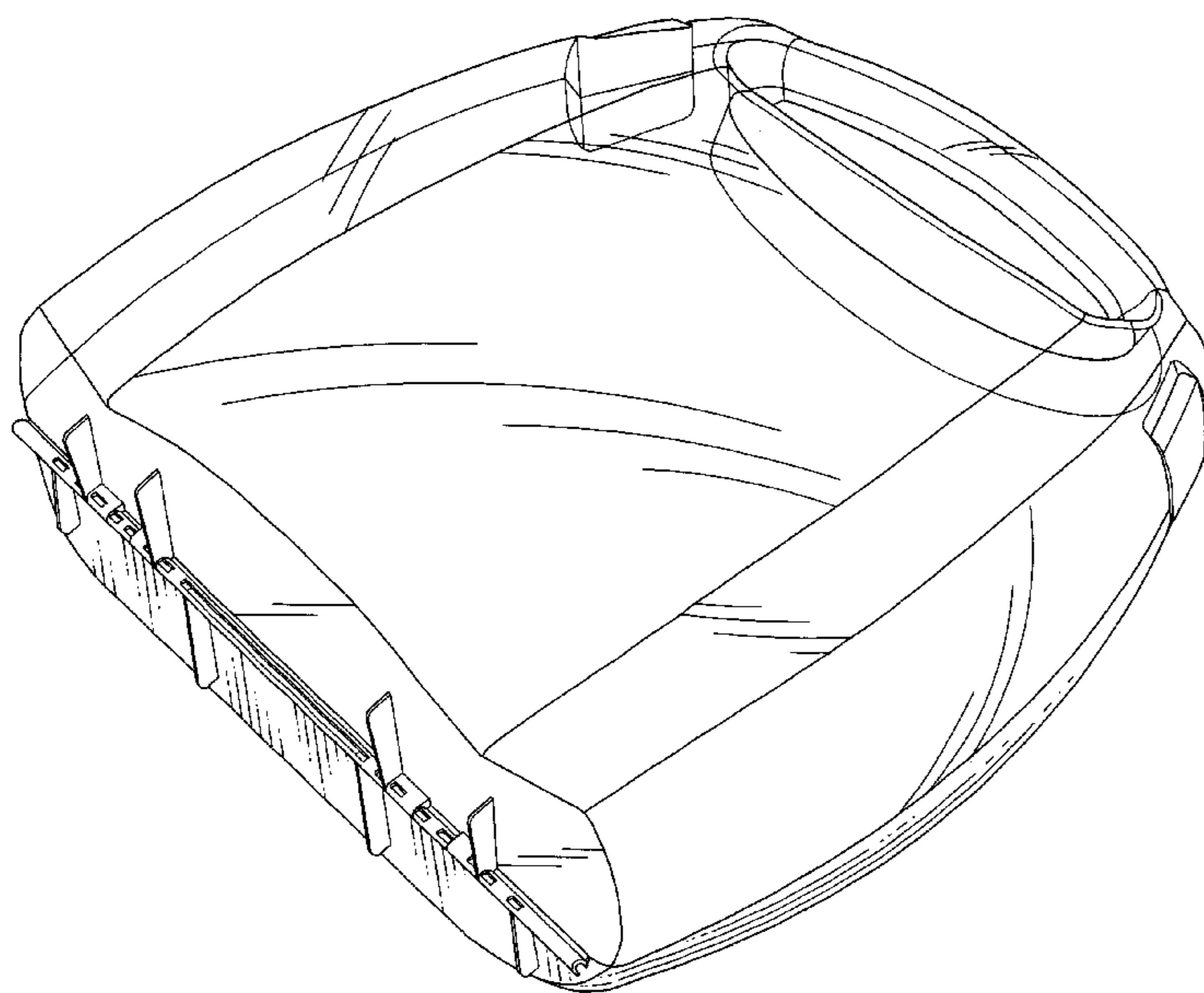

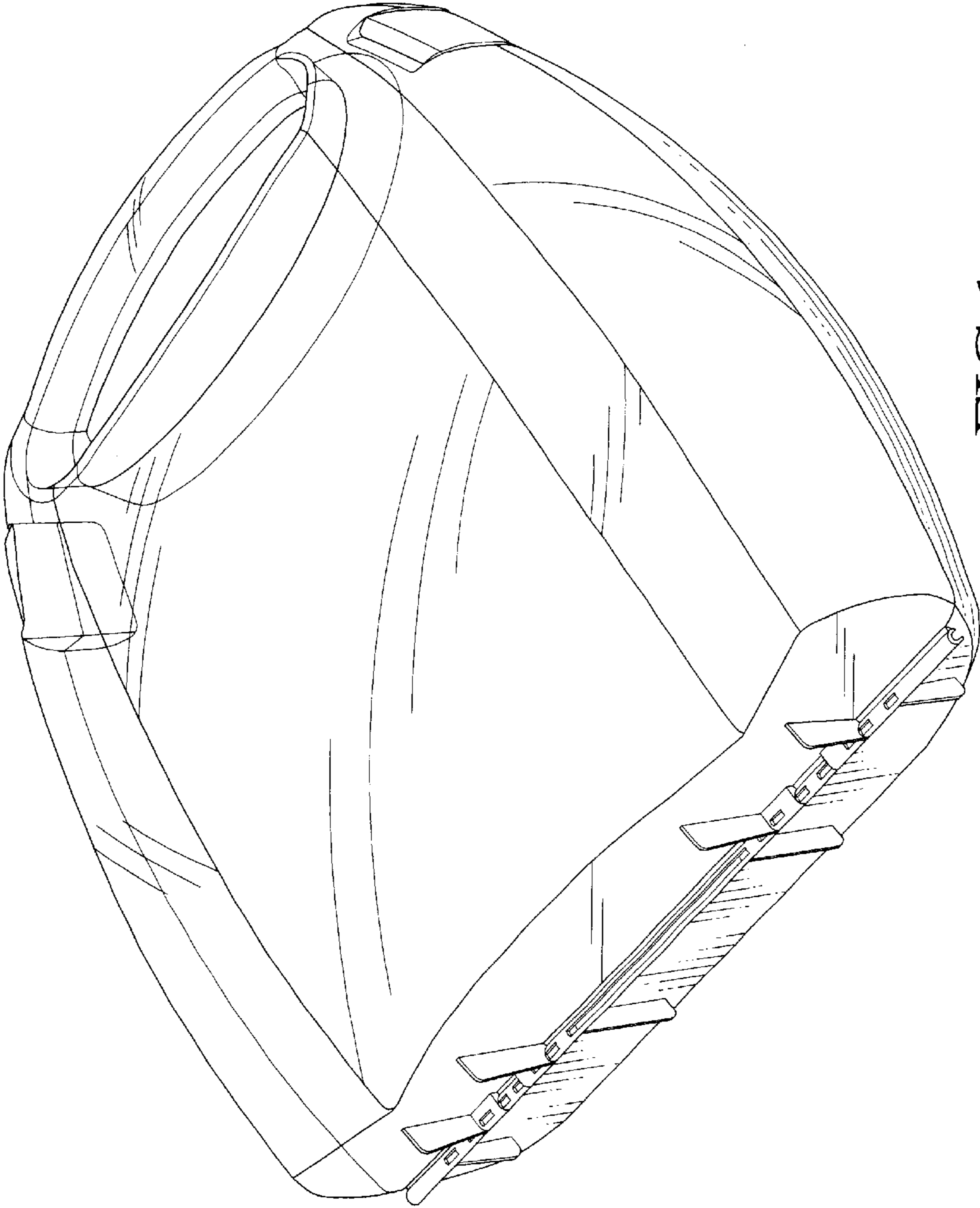

FIG.1

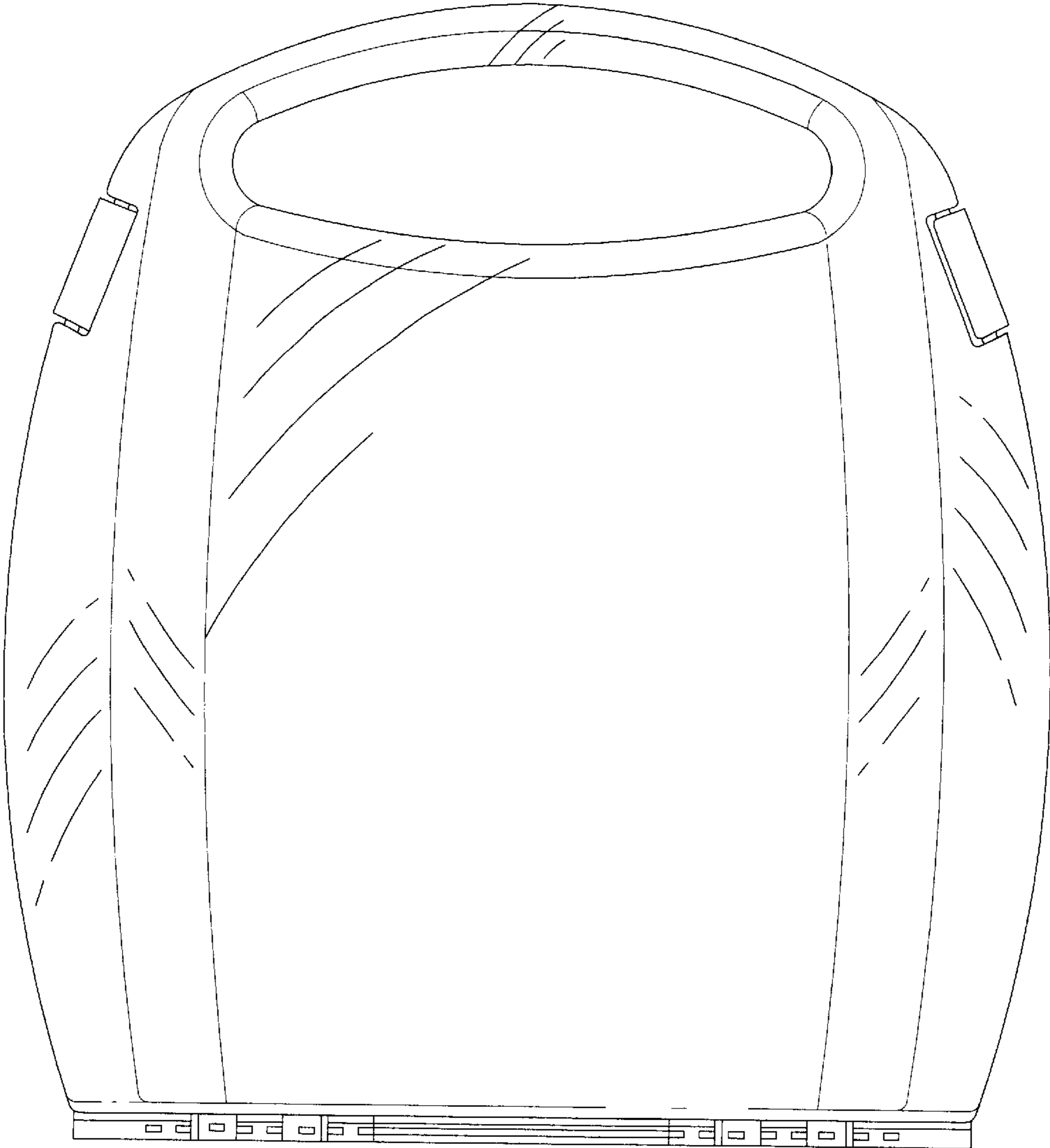

FIG.2

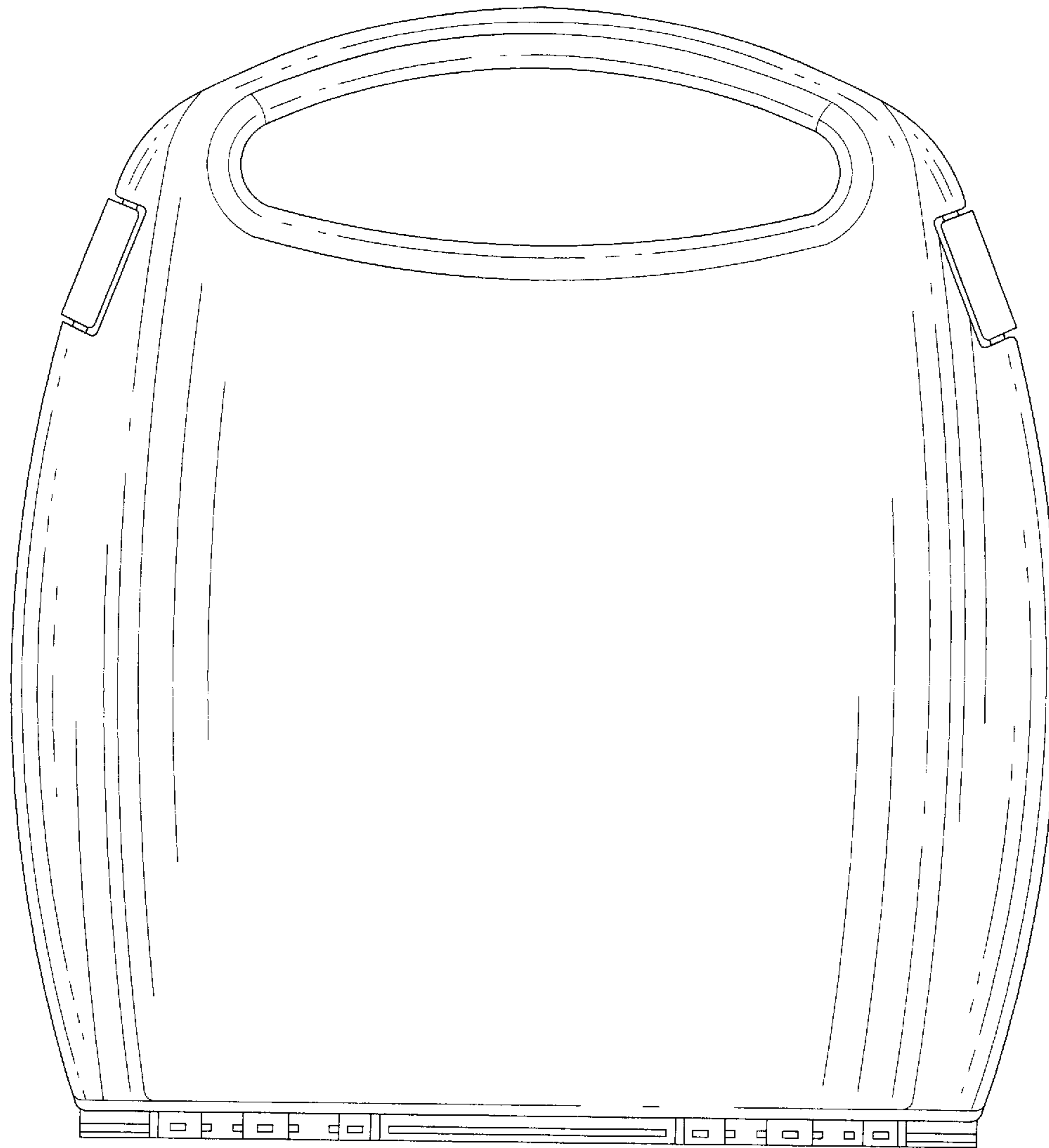

FIG.3

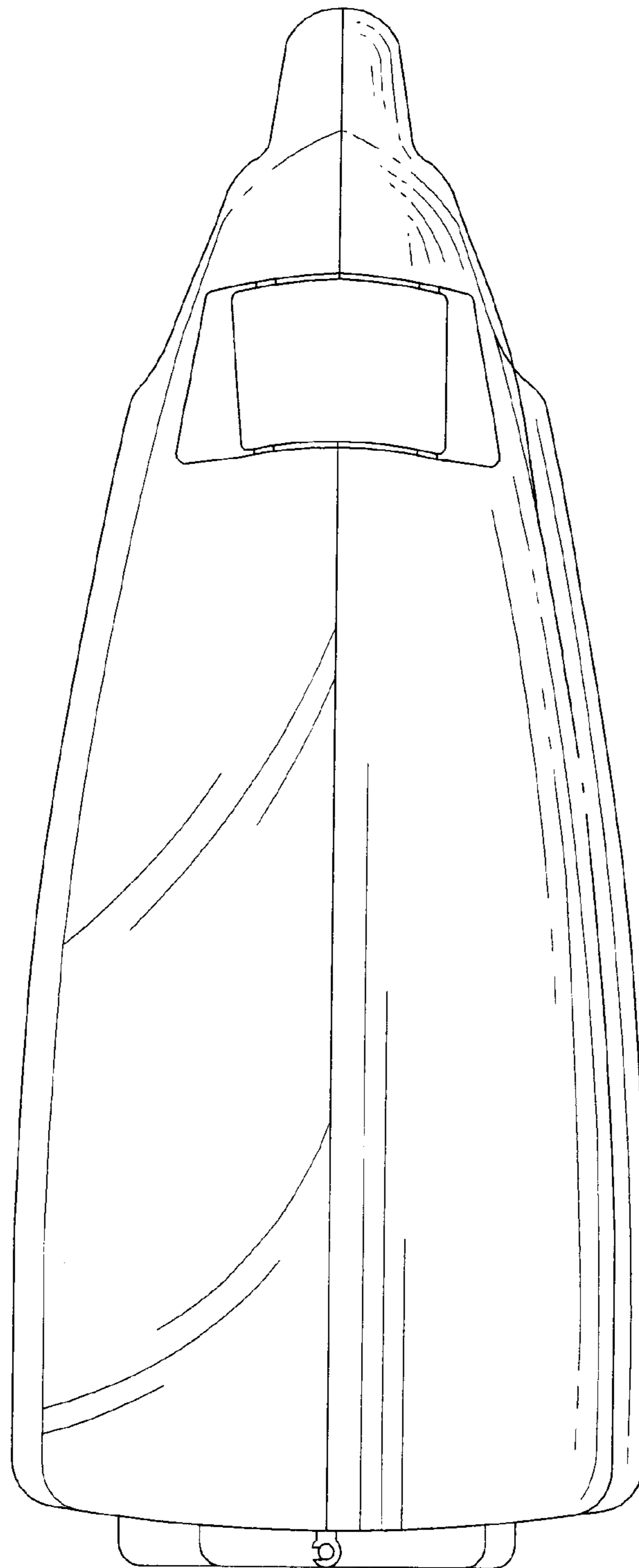

FIG.4

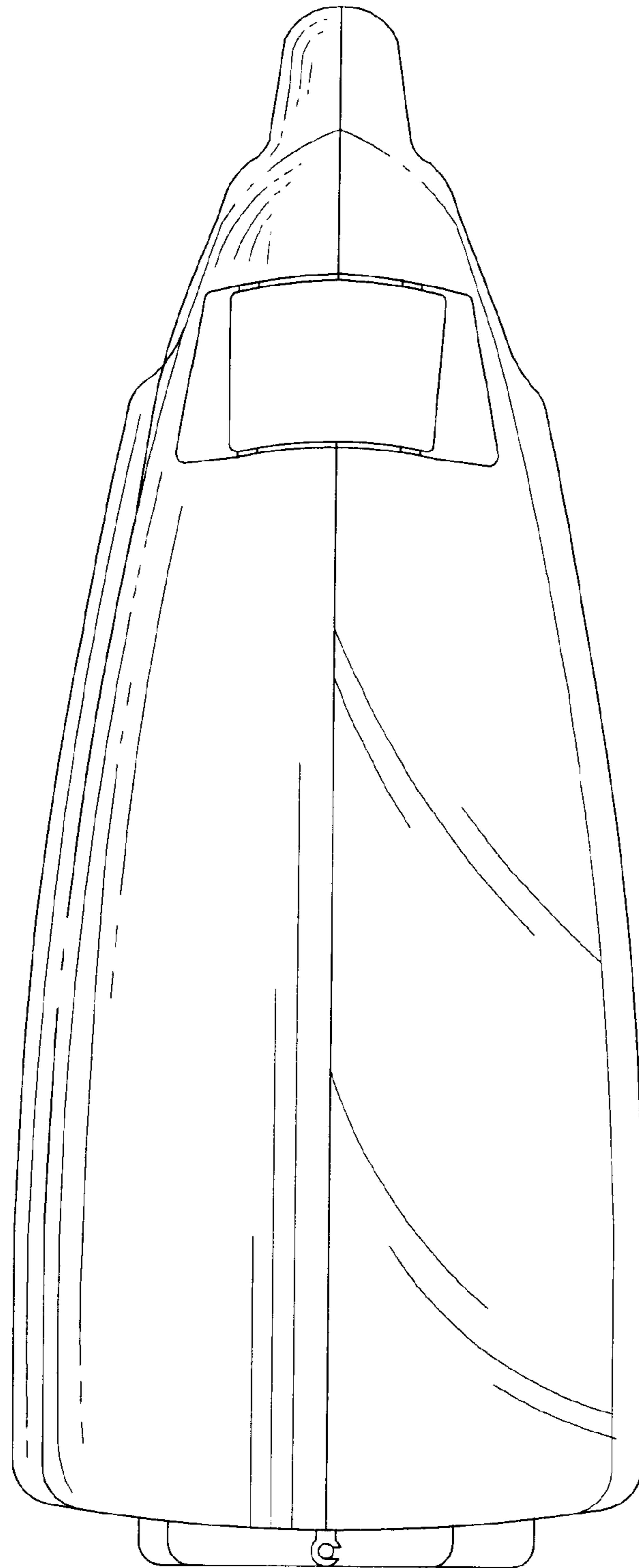

FIG.5



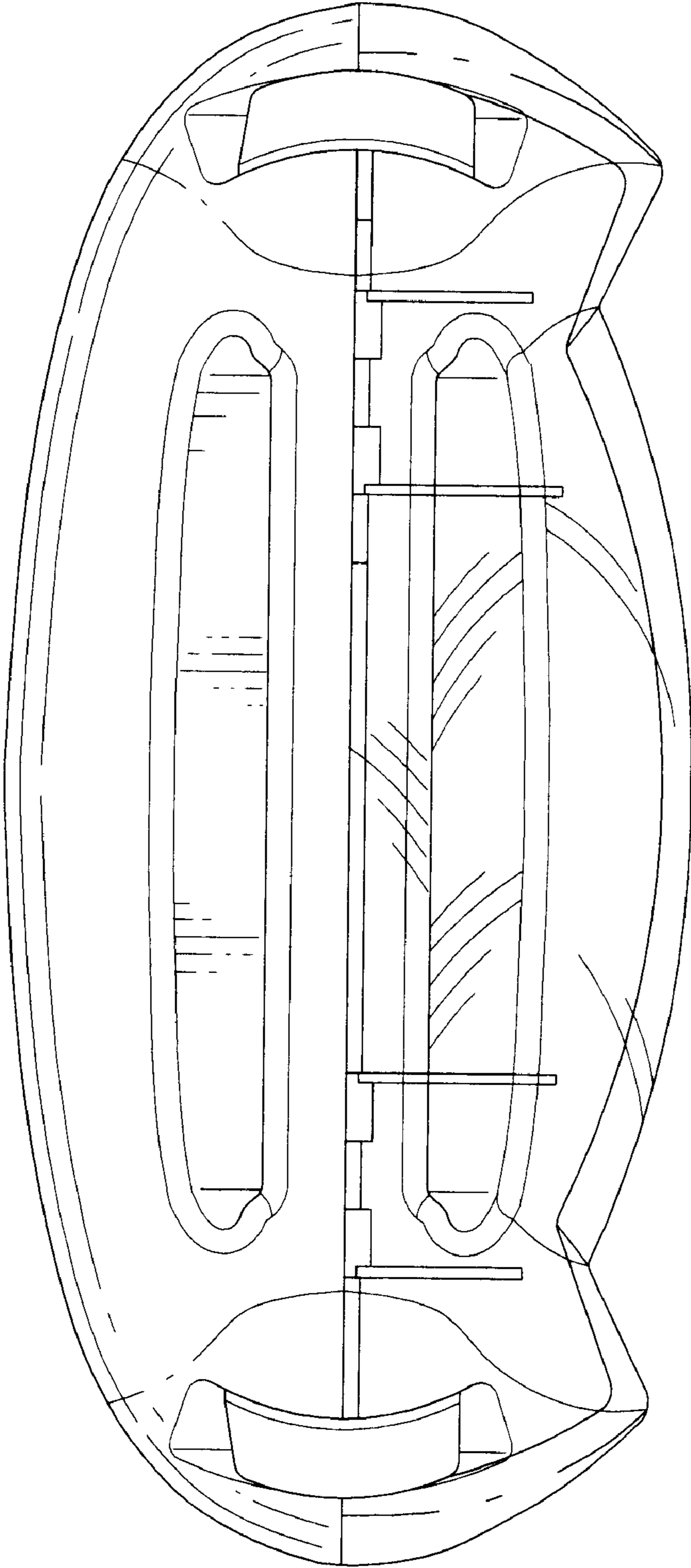

FIG.6

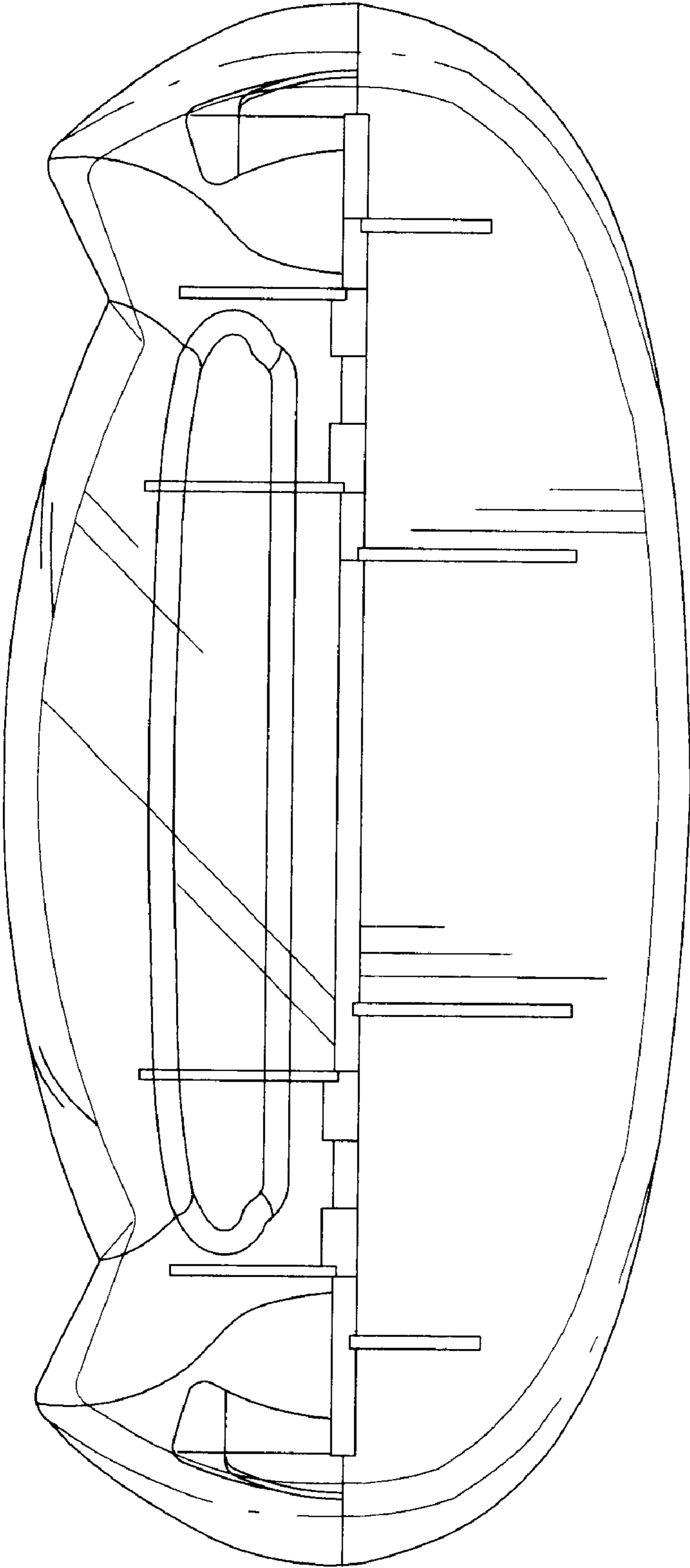

FIG. 7



UNITED STATES PATENT AND TRADEMARK OFFICE  
**CERTIFICATE OF CORRECTION**

PATENT NO. : Des. 537,631 S  
APPLICATION NO. : 29/229841  
DATED : March 6, 2007  
INVENTOR(S) : Su-Min Kung

Page 1 of 1

It is certified that error appears in the above-identified patent and that said Letters Patent is hereby corrected as shown below:

On the Title Page (75), "Inventor: Su-Min kung, Shi-Jr (TW)" should read -- Inventor: Su-Min Kung, Hsi Chih (TW) --

On the Title Page, "Assignee: Hunter Optical Co., Ltd., Taipei Hsien (TW)" should read -- Assignee: Hunter Optical Co., Ltd., Hsi Chih (TW) --

Signed and Sealed this

Twenty Second Day of April, 2008

A handwritten signature in black ink that reads "Jon W. Dudas". The signature is written in a cursive style with a large, looped initial "J".

JON W. DUDAS

*Director of the United States Patent and Trademark Office*