



US00D537620S

(12) **United States Design Patent**
Glennie

(10) **Patent No.:** **US D537,620 S**
(45) **Date of Patent:** **** Mar. 6, 2007**

(54) **CASE**

(75) Inventor: **Nigel Glennie**, London (GB)

(73) Assignee: **Mulberry Imports, Ltd.**, London (GB)

(**) Term: **14 Years**

(21) Appl. No.: **29/240,614**

(22) Filed: **Oct. 14, 2005**

(30) **Foreign Application Priority Data**

Apr. 15, 2005 (EM) 000331277

(51) **LOC (8) Cl.** **03-01**

(52) **U.S. Cl.** **D3/203.5**

(58) **Field of Classification Search** D3/203.5,
D3/201, 205-206, 203.6, 219, 265, 294;
D9/529, 549, 575; 206/581, 5, 5.1, 6, 38;
248/902; D28/72, 82

See application file for complete search history.

(56) **References Cited**

U.S. PATENT DOCUMENTS

D408,626 S * 4/1999 Lage D3/203.5
D425,299 S * 5/2000 Charbonneau D3/265

(Continued)

Primary Examiner—Catherine R. Oliver

(74) *Attorney, Agent, or Firm*—Myers Bigel Sibley & Sajovec, P.A.

(57) **CLAIM**

The ornamental design for a case, as shown and described.

DESCRIPTION

FIG. 1 is a front perspective view showing my new case in a closed configuration;

FIG. 2 is a front view thereof, the opposing rear view thereof being identical to the front view;

FIG. 3 is a side view thereof, the opposing side view being identical to the side view of FIG. 3;

FIG. 4 is a first end view thereof;

FIG. 5 is a second opposing end view thereof;

FIG. 6 is a front view of the case of FIG. 1 in an open configuration;

FIG. 7 is a front view showing a second embodiment of my new case, the opposing rear view thereof being identical to the front view;

FIG. 8 is a side view thereof, the opposing side view being identical to the side view of FIG. 8;

FIG. 9 is a first end view thereof;

FIG. 10 is a second opposing end view thereof;

FIG. 11 is a front view showing a third embodiment of my new case, the opposing rear view thereof being identical to the front view, the first and second end views thereof being identical to those shown in FIGS. 9 and 10, respectively;

FIG. 12 is a side view thereof, the opposing side view being identical to the side view of FIG. 12;

FIG. 13 is a front view showing a fourth embodiment of my new case, the opposing rear view thereof being identical to the front view, the first and second end views thereof being identical to those shown in FIGS. 9 and 10, respectively, the side views thereof being identical to one another and corresponding to the side view of FIG. 12 except for the omission of surfaces with visually contrasting colors, textures or materials;

FIG. 14 is a front view showing a fifth embodiment of my new case, the opposing rear view thereof being identical to the front view, the first and second end views thereof being identical to those shown in FIGS. 9 and 10, respectively;

FIG. 15 is a side view thereof, the opposing side view being identical to the side view of FIG. 15; and,

FIG. 16 is a front view showing a sixth embodiment of my new case, the opposing rear view thereof being identical to the front view, the first and second end views thereof being identical to those shown in FIGS. 9 and 10, respectively, the side views thereof being identical to one another and corresponding to the side view of FIG. 15 except for the omission of surfaces with visually contrasting colors, textures or materials.

In certain embodiments of the design as shown in FIGS. 7-10, 11, 12, 14, 15 and 16, different portions of the case may be formed with respective visually ornamental contrasting colors, textures or materials as shown by the respective shading and non-shading on the surfaces thereof.

1 Claim, 9 Drawing Sheets

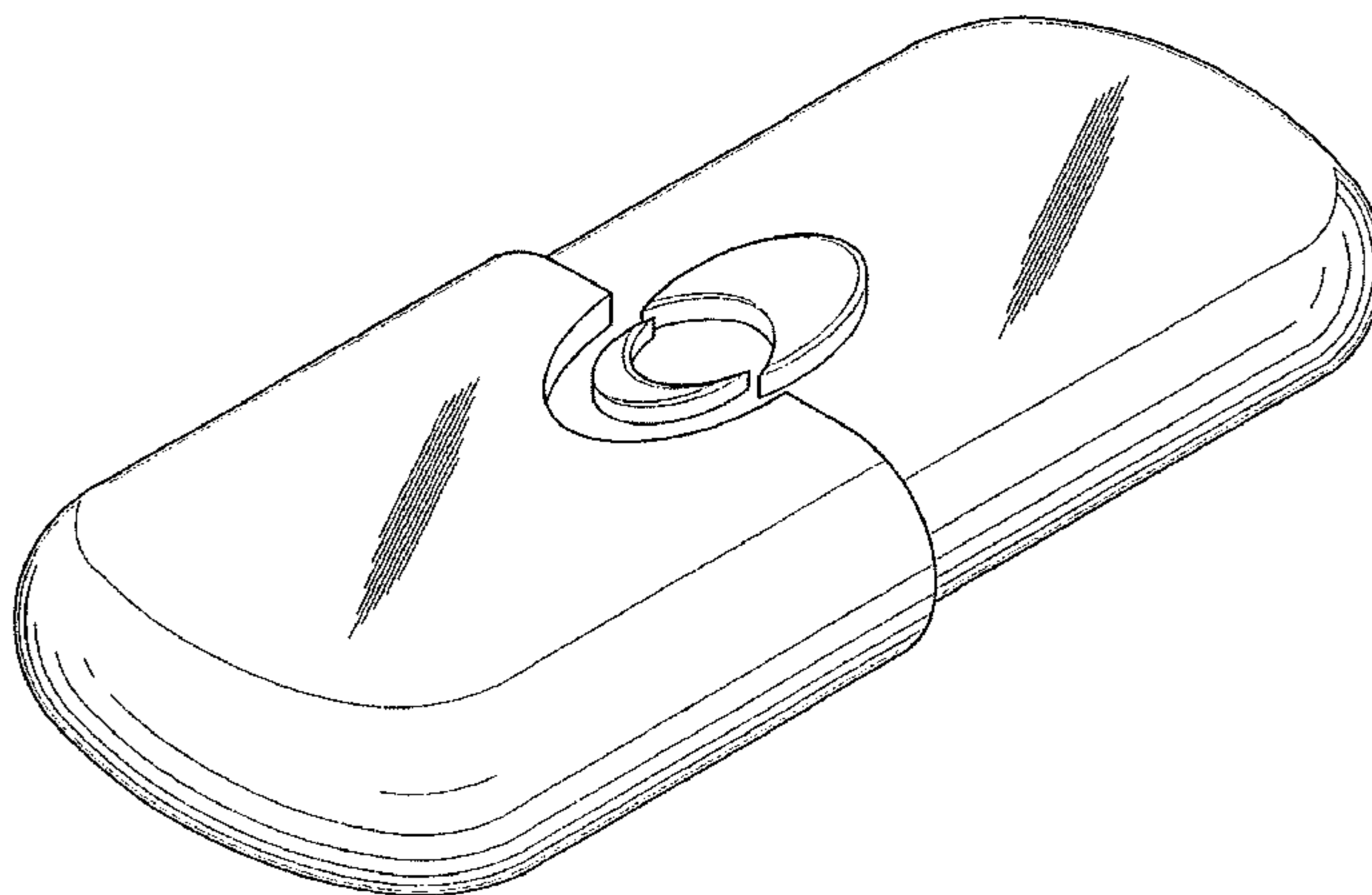

US D537,620 S

Page 2

U.S. PATENT DOCUMENTS

D427,424 S	*	7/2000	Conway	D3/203.5	D499,653 S	*	12/2004	Karim	D9/529
D432,784 S	*	10/2000	Conway	D3/203.5	D510,029 S	*	9/2005	Marcot	D9/529
D498,421 S	*	11/2004	Kostow	D9/529	D513,992 S	*	1/2006	Boyd	D9/529

* cited by examiner

Fig. 1

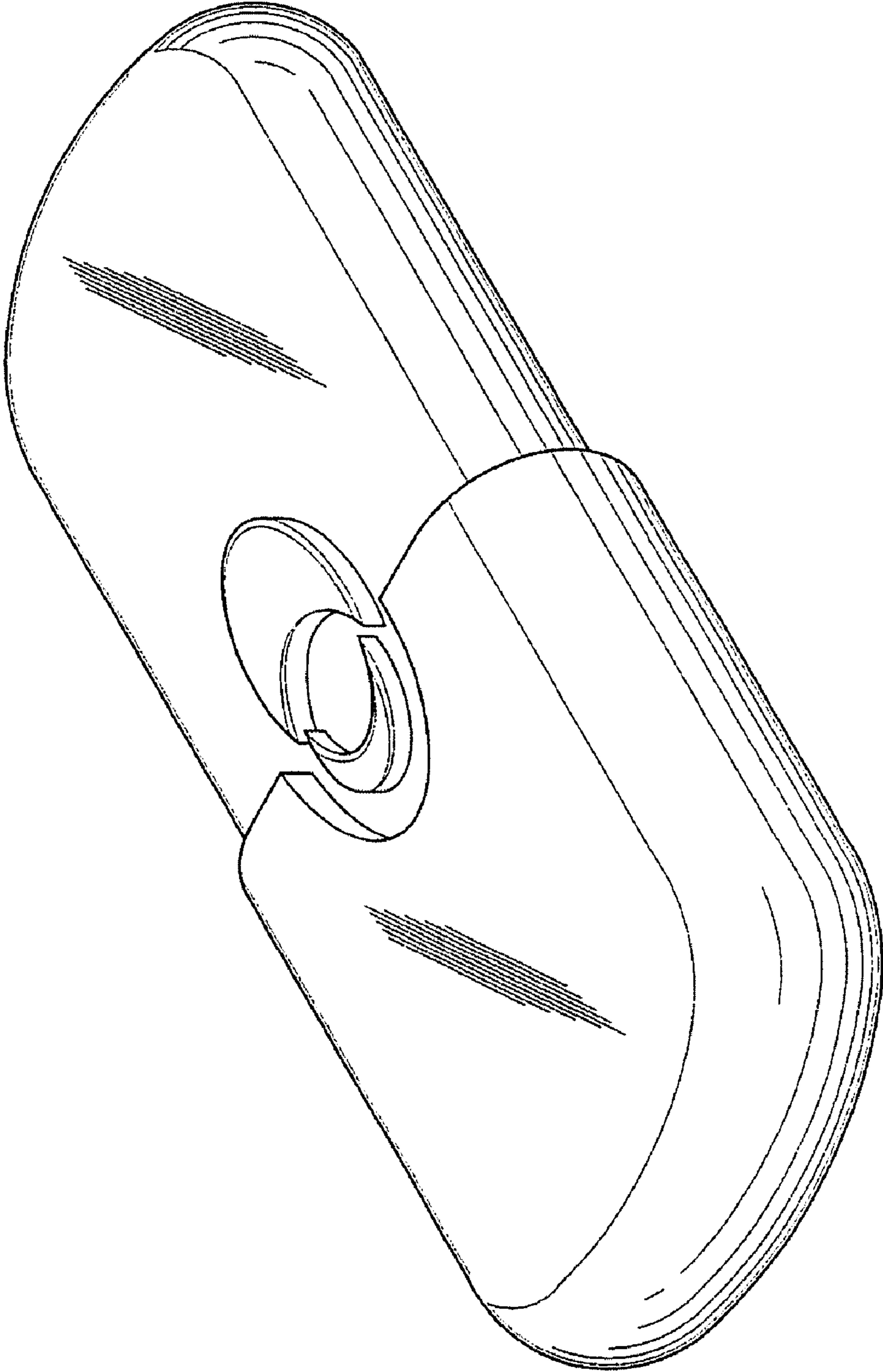

Fig. 2

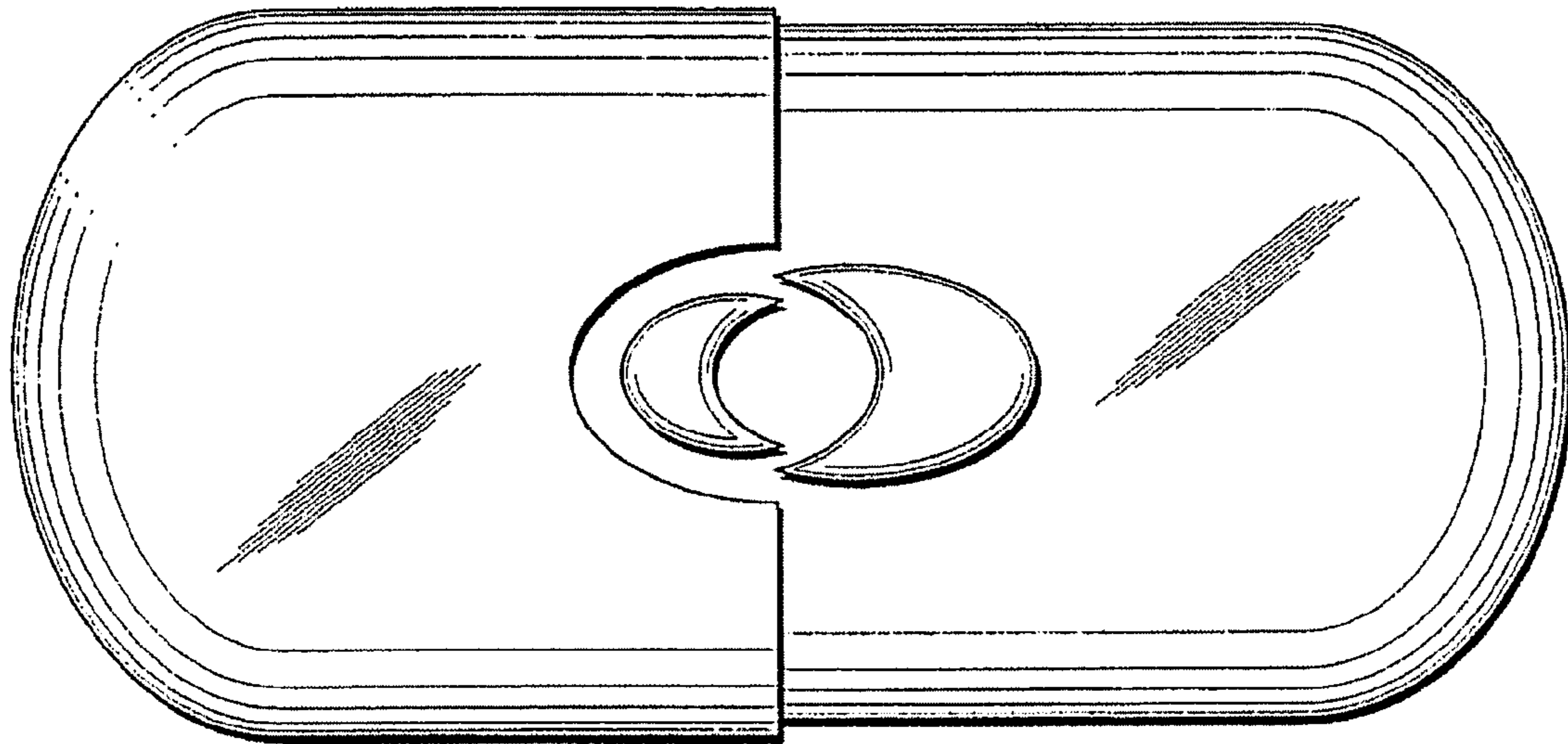

Fig. 3

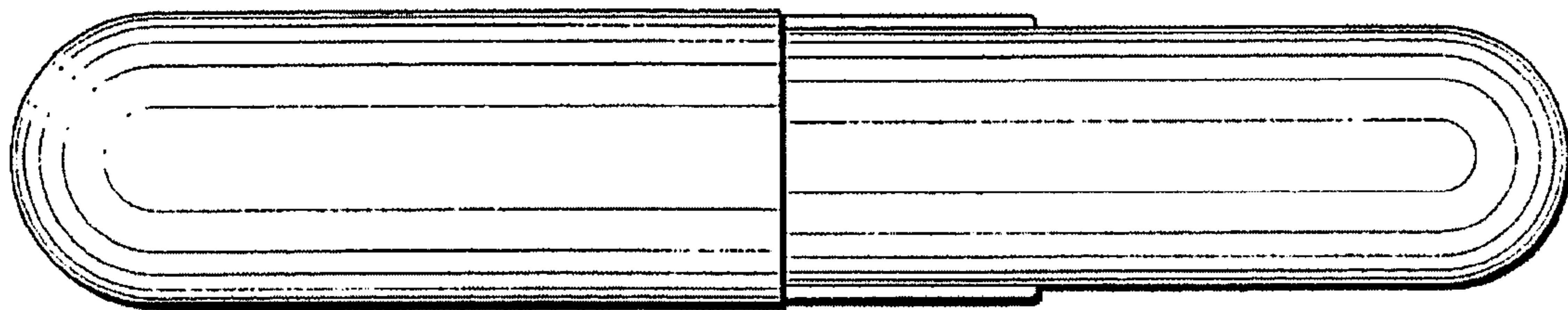

Fig. 4

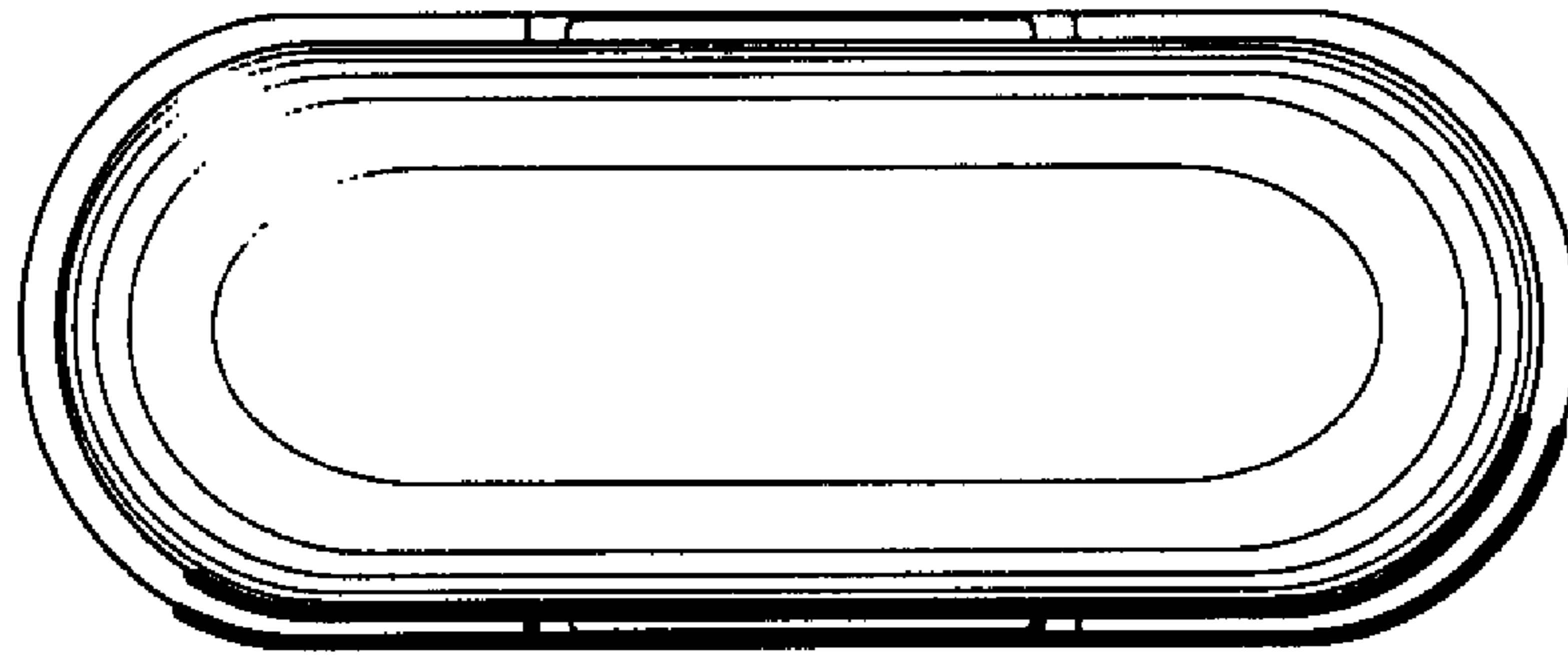

Fig. 5

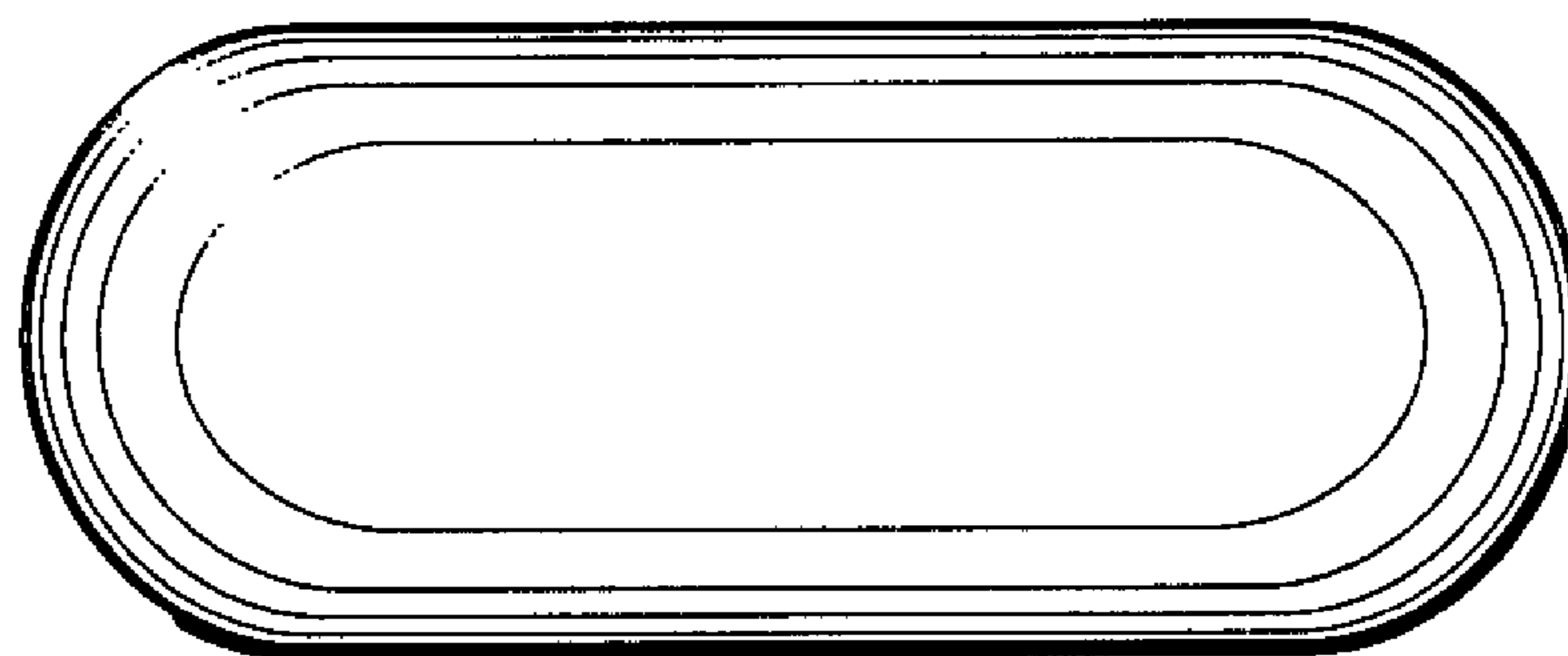

Fig. 6

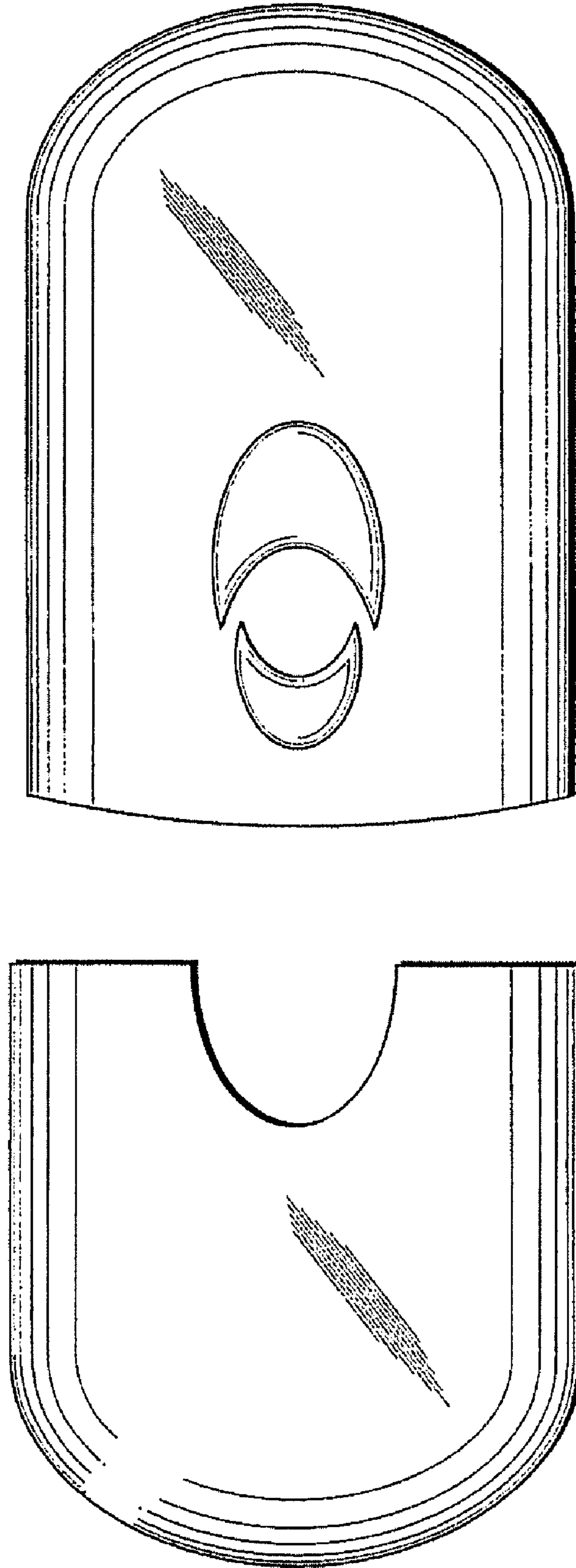

Fig. 7

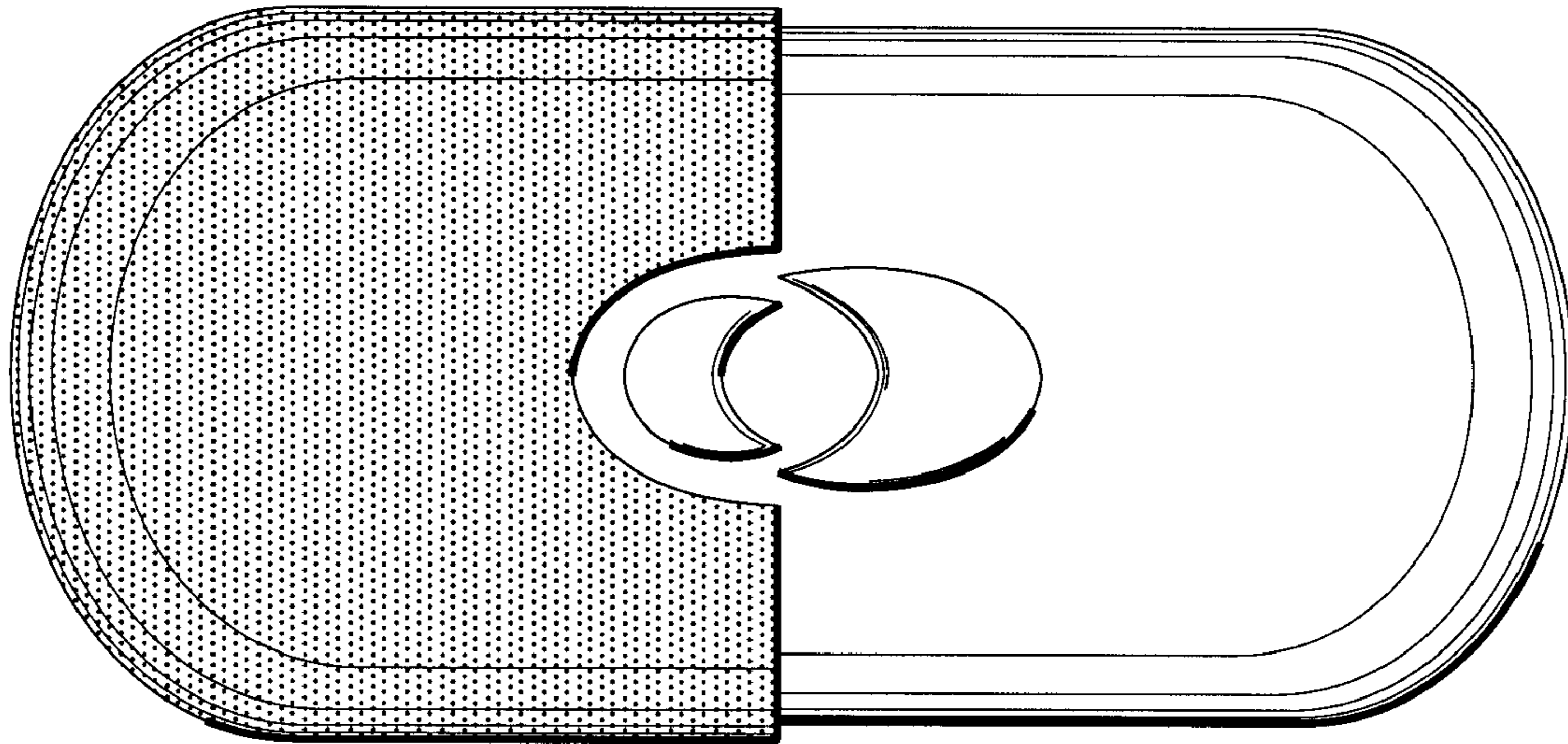

Fig. 8

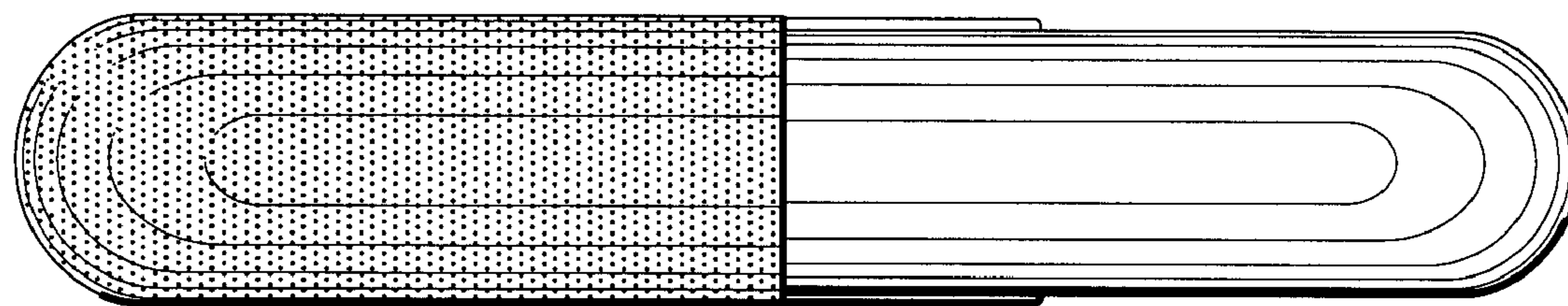

Fig. 9

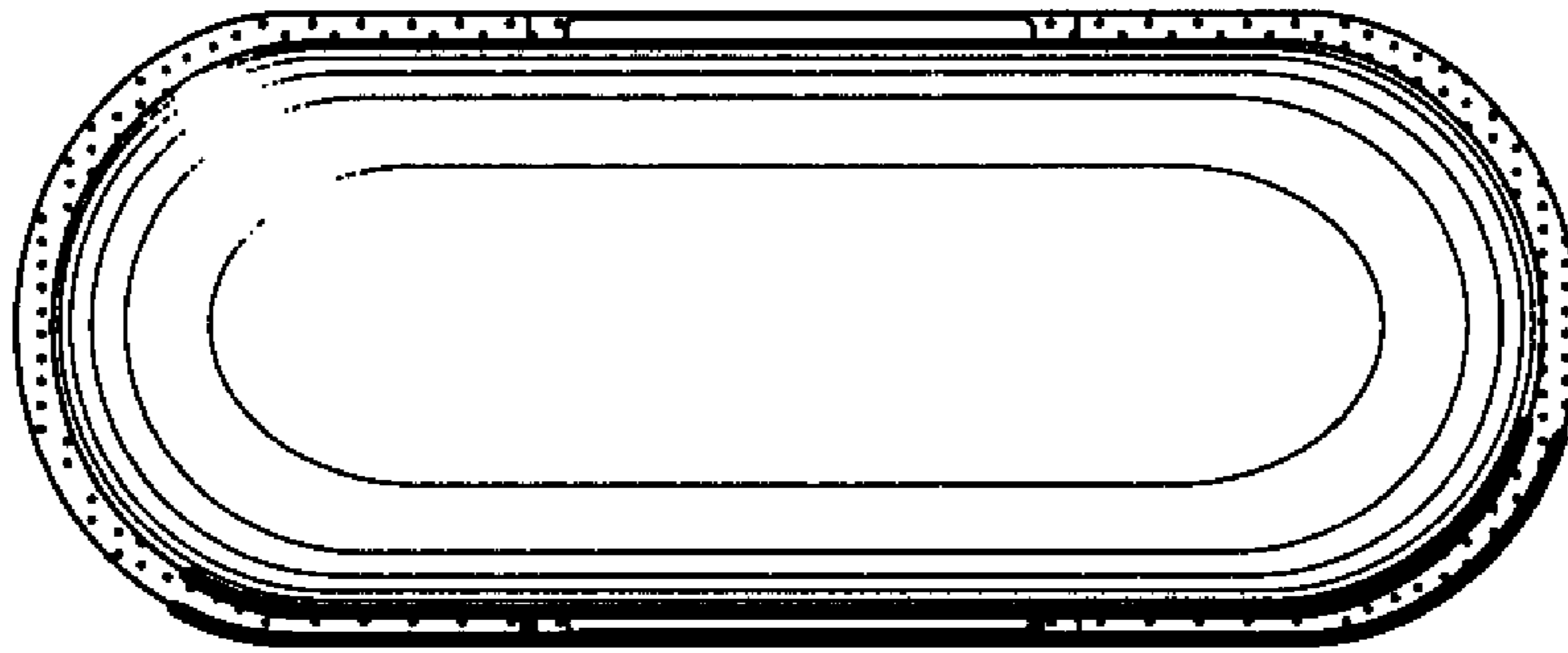

Fig. 10

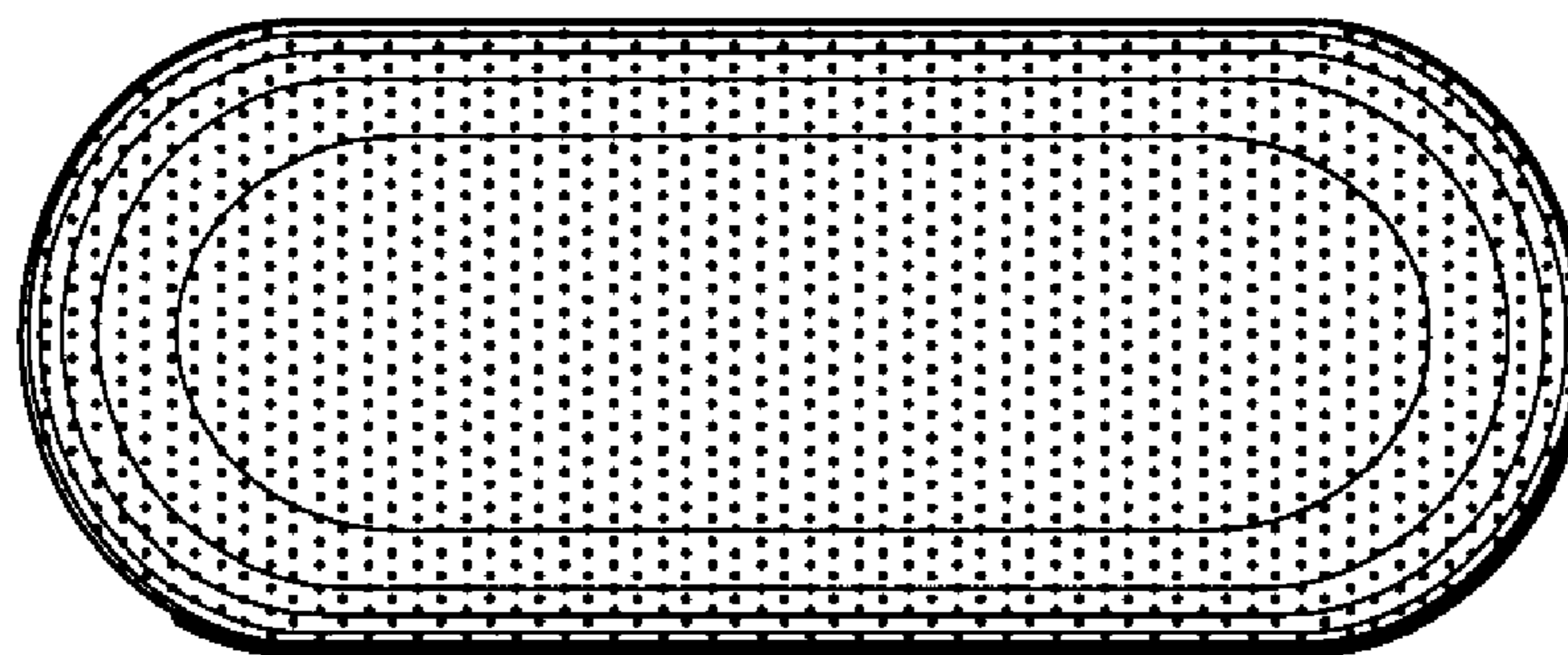

Fig. 11

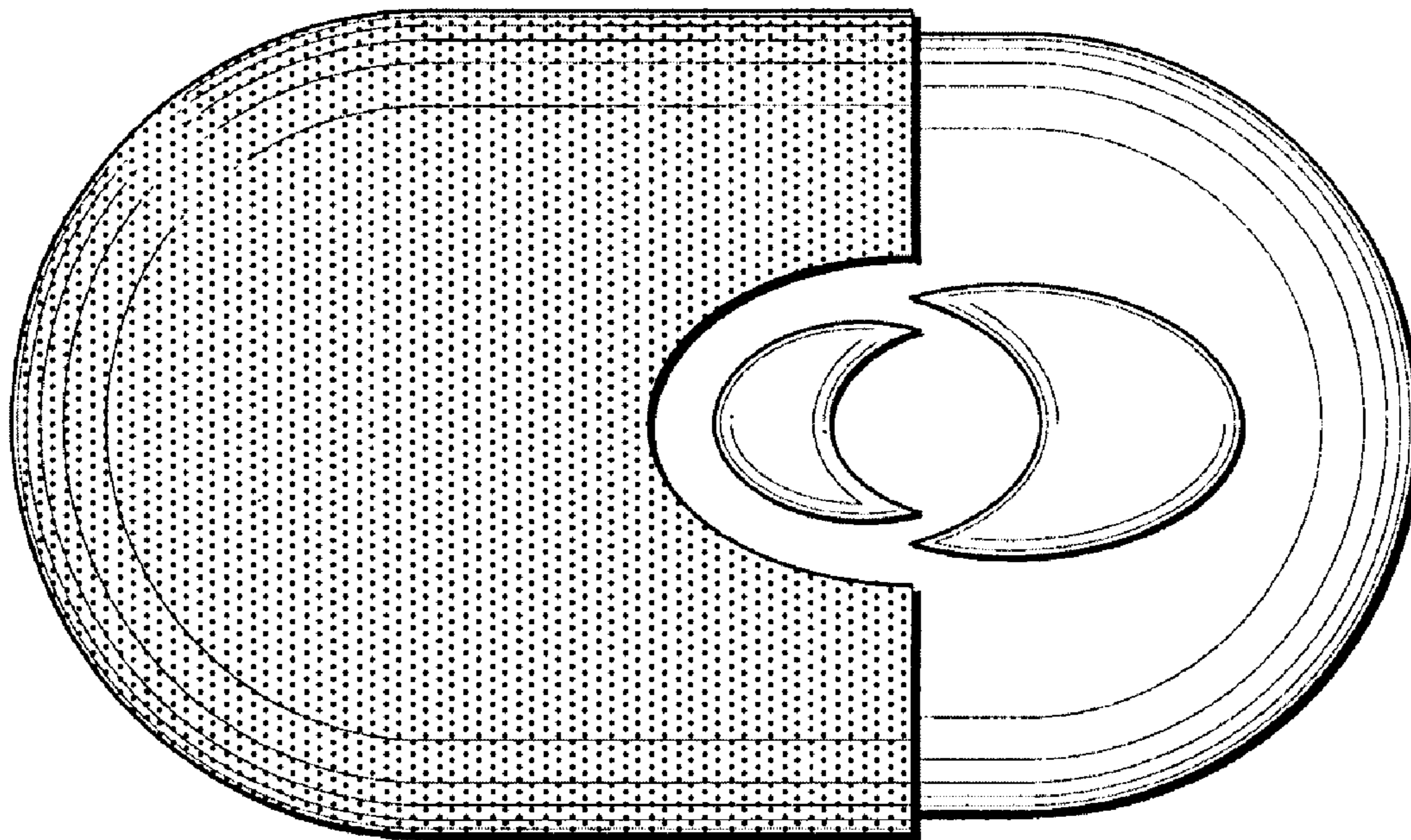

Fig. 12

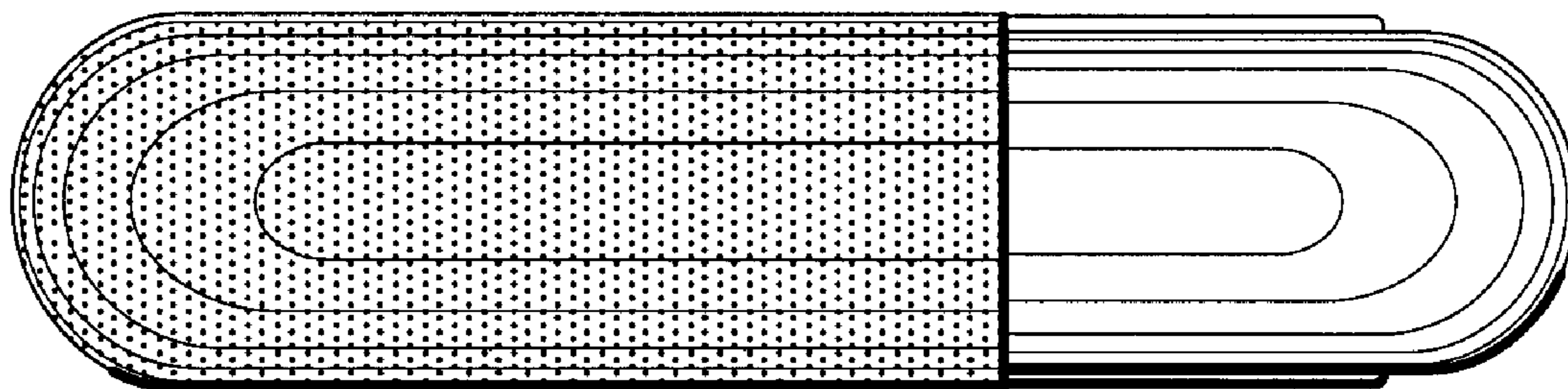

Fig. 13

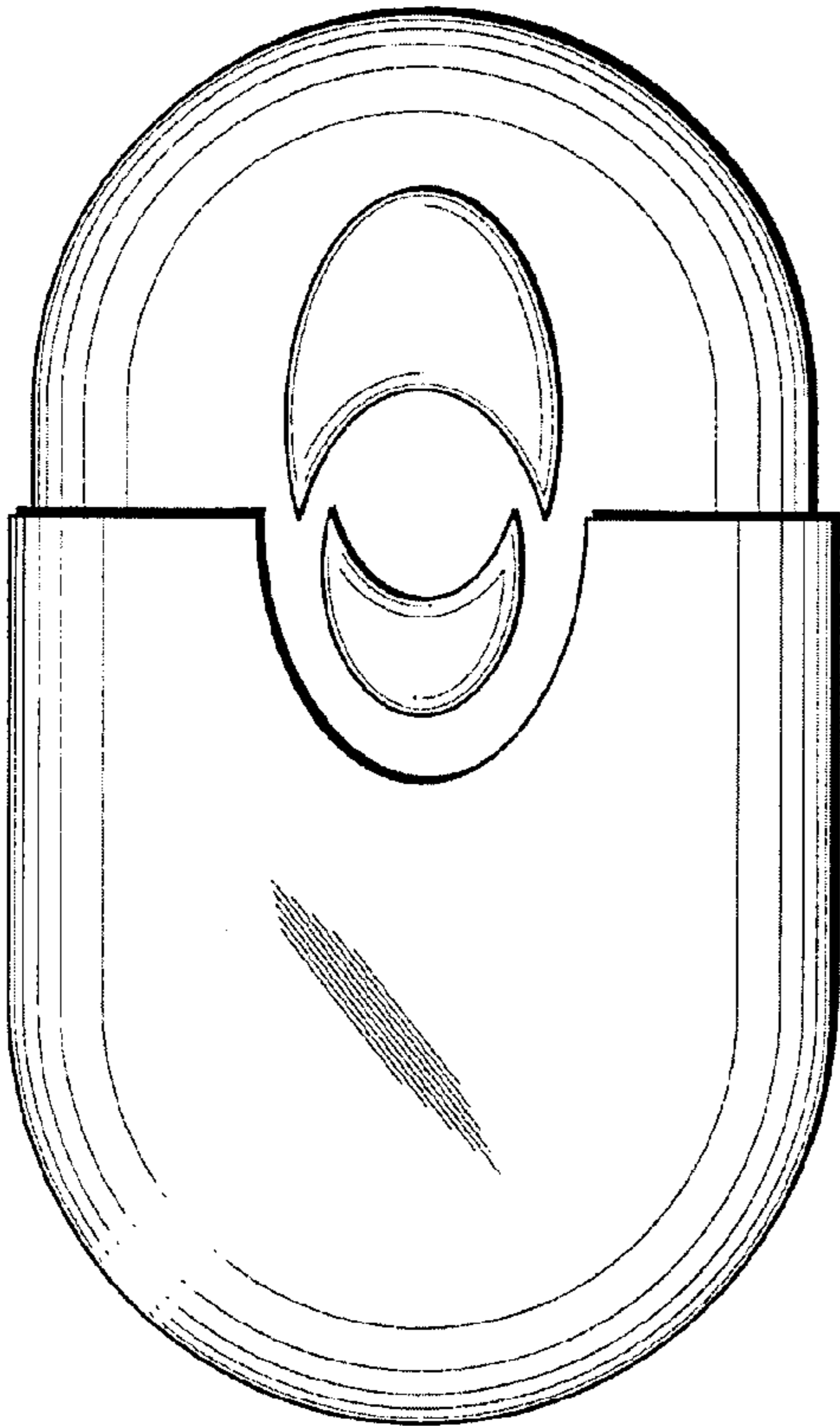

Fig. 16

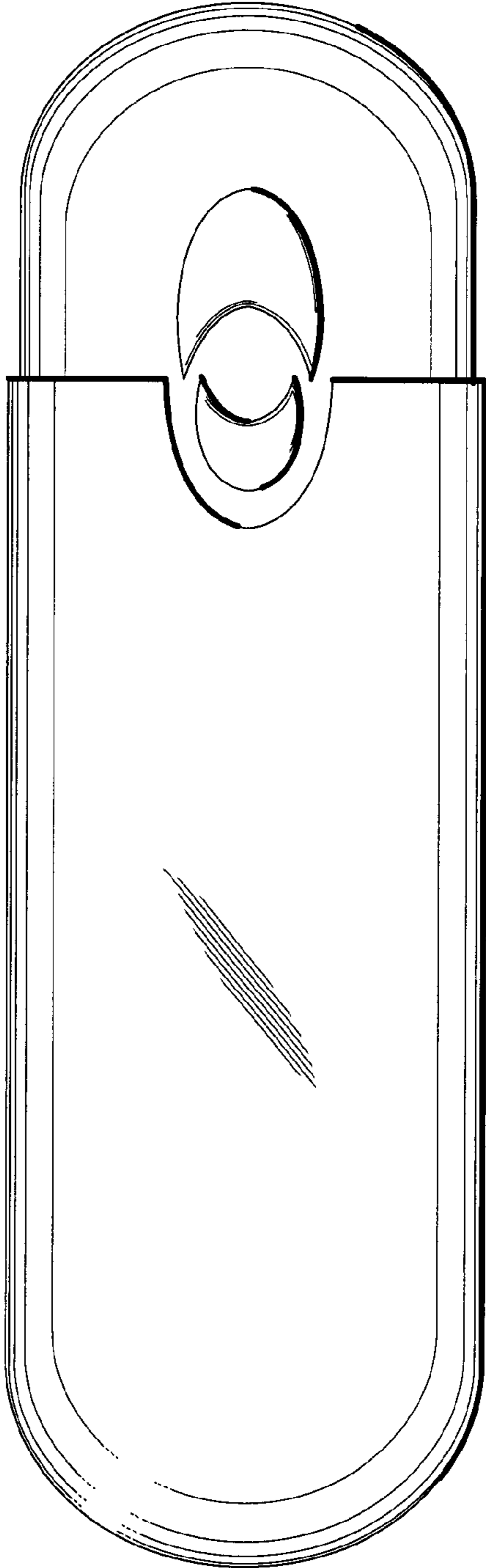

Fig. 14

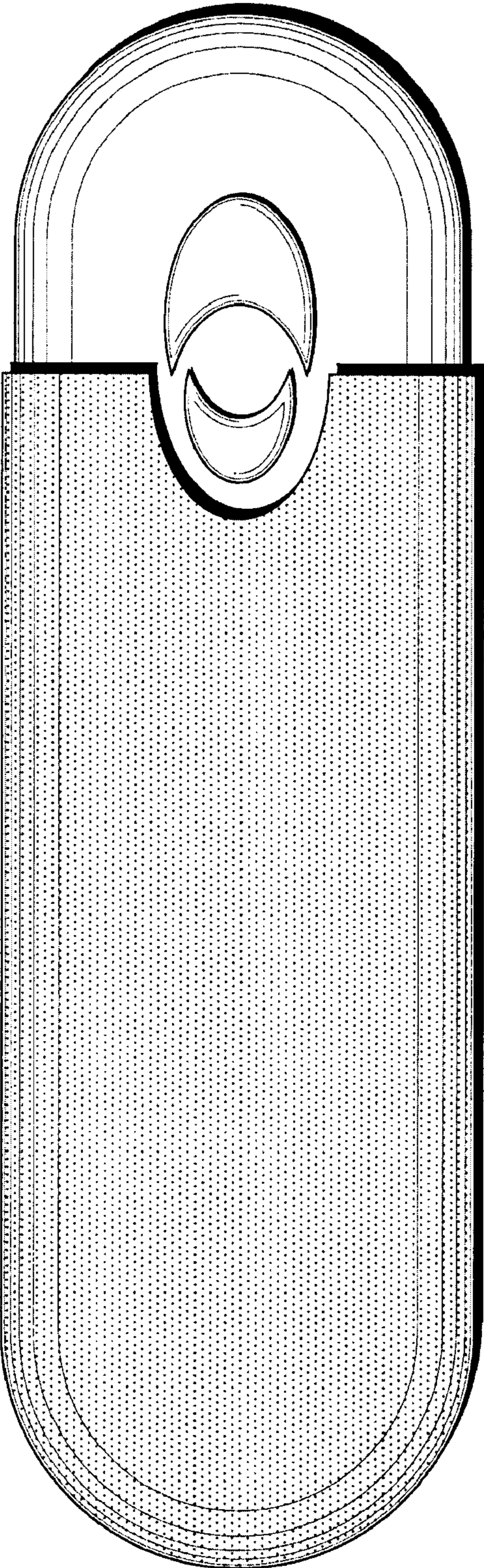

Fig. 15

