



US00D537439S

(12) **United States Design Patent**
Helin

(10) **Patent No.:** **US D537,439 S**

(45) **Date of Patent:** **** Feb. 27, 2007**

(54) **FRONT COVER PORTION OF A COMMUNICATOR**

(75) Inventor: **Totti Helin**, Helsinki (FI)

(73) Assignee: **Nokia Corporation**, Espoo (FI)

(**) Term: **14 Years**

(21) Appl. No.: **29/211,452**

(22) Filed: **Aug. 17, 2004**

(30) **Foreign Application Priority Data**

Feb. 17, 2004 (FI) M20040021

(51) **LOC (8) Cl.** **14-03**

(52) **U.S. Cl.** **D14/248**

(58) **Field of Classification Search** D14/137,
D14/138, 147-148, 247-248, 144, 218, 341-347,
D14/455, 456; 379/433.01-433.13, 434;
455/575.1, 566, 556.1; D21/517, 329, 331;
345/169

See application file for complete search history.

(56) **References Cited**

U.S. PATENT DOCUMENTS

- 5,189,632 A * 2/1993 Paajanen et al. 708/109
- D340,927 S * 11/1993 Goatman D14/137
- 5,414,444 A * 5/1995 Britz 345/156
- D377,341 S * 1/1997 Imai et al. D14/343
- 5,703,947 A * 12/1997 Hino et al. 379/419
- D389,838 S * 1/1998 Brunner et al. D14/218
- D390,541 S * 2/1998 Chiba D14/345
- D392,968 S 3/1998 Johansson
- D395,431 S * 6/1998 Harris et al. D14/138
- D398,307 S * 9/1998 Collins D14/144
- D408,397 S * 4/1999 Renard D14/138
- D413,597 S * 9/1999 Oba D14/144
- D416,255 S 11/1999 Johansson
- D417,657 S * 12/1999 Matsumoto D14/343
- D426,218 S * 6/2000 Abed et al. D14/138
- D426,219 S * 6/2000 Gulino et al. D14/138
- 6,259,932 B1 * 7/2001 Constien 455/556.1
- D447,740 S 9/2001 Johansson

- D459,717 S 7/2002 Bohne
- 6,445,932 B1 * 9/2002 Soini et al. 455/556.1
- 6,487,396 B1 * 11/2002 Sassi 455/90.1
- D480,057 S * 9/2003 Ho-Cheun et al. D14/138
- D487,438 S * 3/2004 Sheu D14/138
- D487,886 S * 3/2004 Ho-Cheun et al. D14/138
- 6,725,064 B1 * 4/2004 Wakamatsu et al. 455/566
- D494,561 S * 8/2004 Kagami et al. D14/138
- D495,307 S * 8/2004 Yau et al. D14/138
- D498,735 S * 11/2004 Chen et al. D14/138
- D519,094 S * 4/2006 Helin D14/138
- 2003/0073456 A1 * 4/2003 Griffin et al. 455/550
- 2003/0090468 A1 * 5/2003 Finke-Anlauff 345/169
- 2004/0058720 A1 * 3/2004 Kubo et al. 455/575.1
- 2004/0198248 A1 * 10/2004 Krenz et al. 455/90.1

FOREIGN PATENT DOCUMENTS

- EM 000104328-0001 1/2004
- EM 000104328-0002 1/2004
- EM 000104328-0003 1/2004
- EM 000104328-0004 1/2004
- EM 000104328-0005 1/2004
- WO DM/066460 * 3/2005

* cited by examiner

Primary Examiner—Jeffrey Asch

(74) *Attorney, Agent, or Firm*—Banner & Witcoff, Ltd.

(57) **CLAIM**

The ornamental design for a front cover portion of a communicator, as shown and described.

DESCRIPTION

FIG. 1 is a bottom plan view of a front cover portion of a communicator showing my new design;
 FIG. 2 is a right side view thereof;
 FIG. 3 is a front view thereof;
 FIG. 4 is a left side view thereof;
 FIG. 5 is a top plan view thereof; and,
 FIG. 6 is a perspective front view thereof.
 The broken line showing of the remainder of the communicator in FIGS. 1-6 is for illustrative purposes only and forms no part of the claimed design.

1 Claim, 3 Drawing Sheets

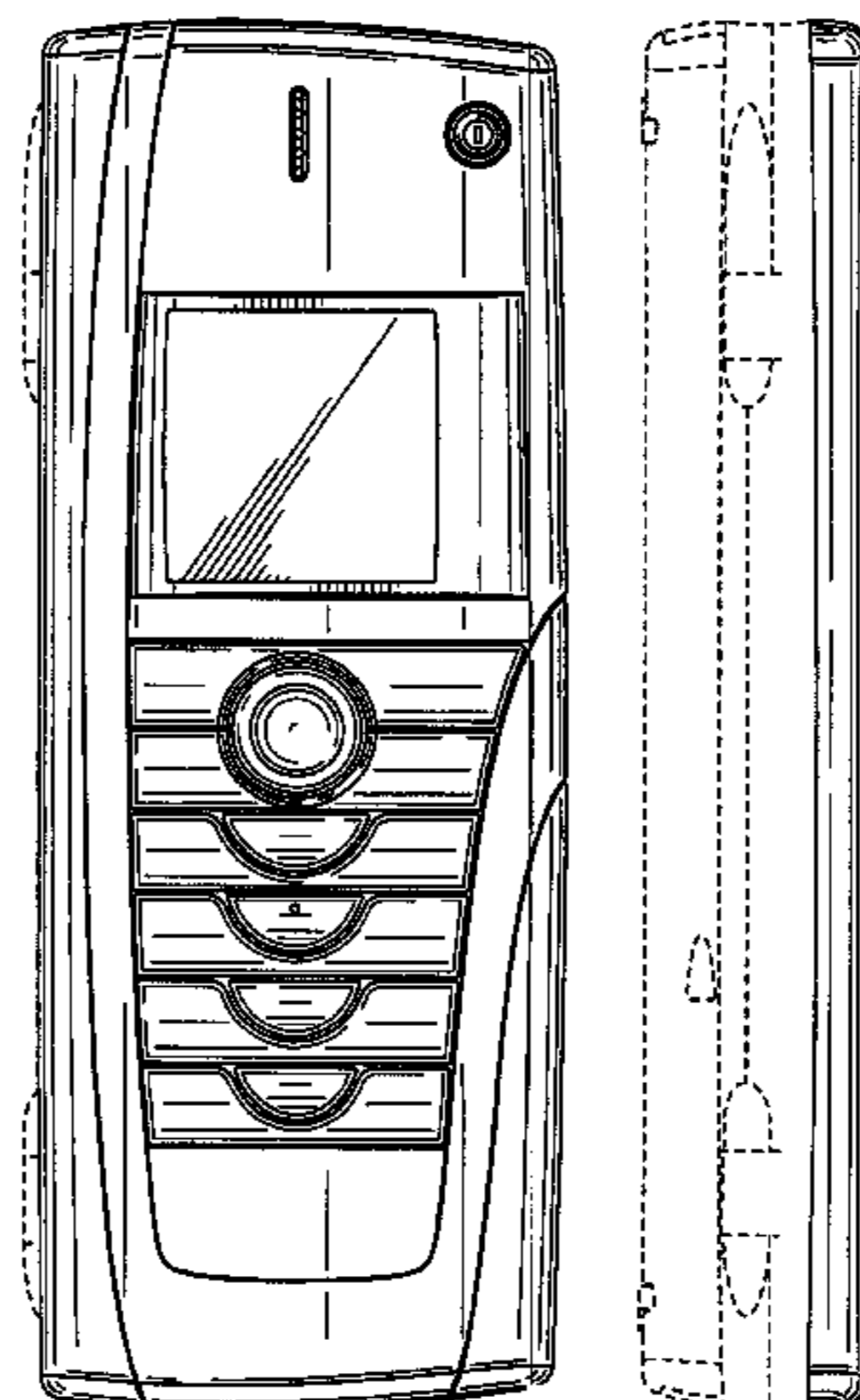

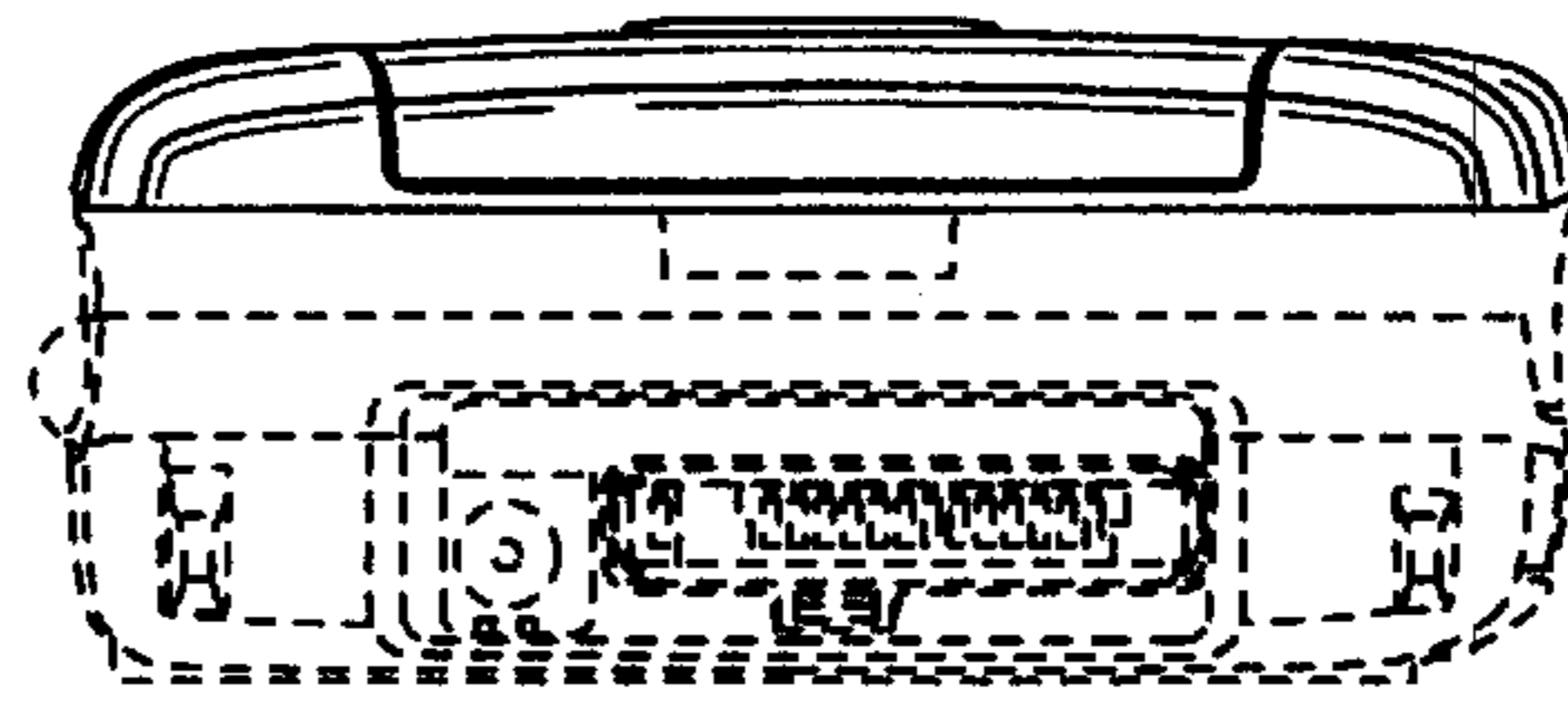

FIG. 1

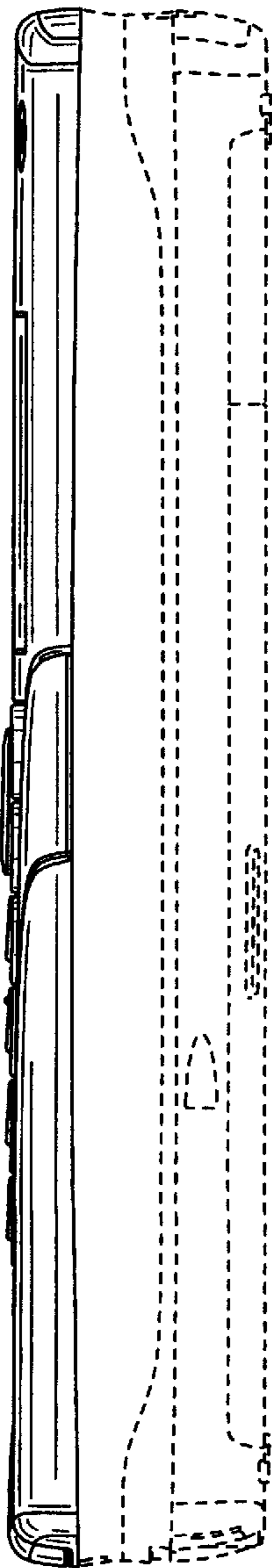

FIG. 2

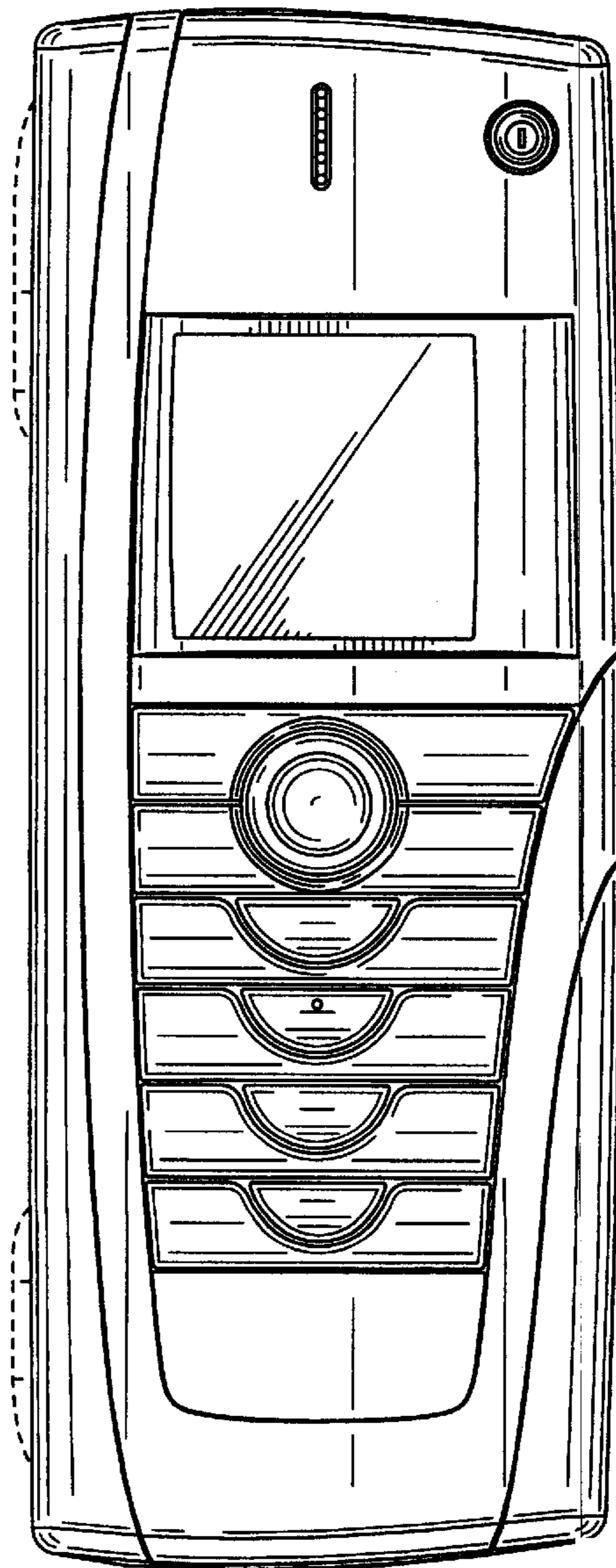

FIG. 3

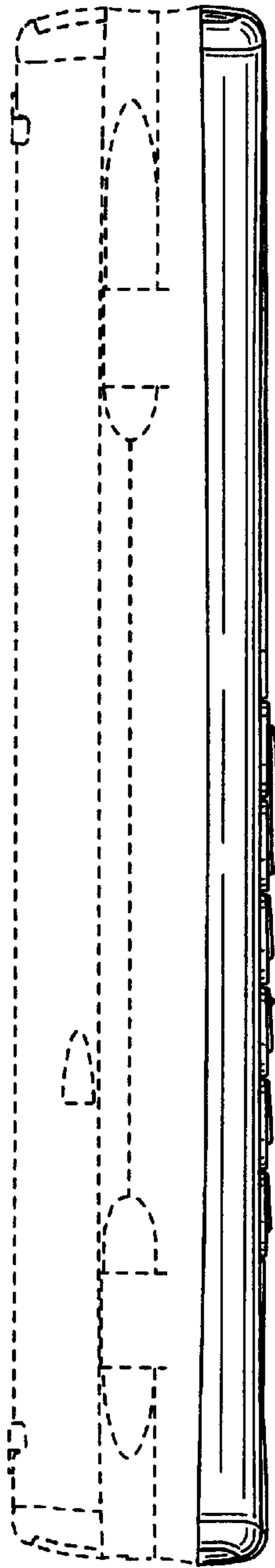

FIG. 4

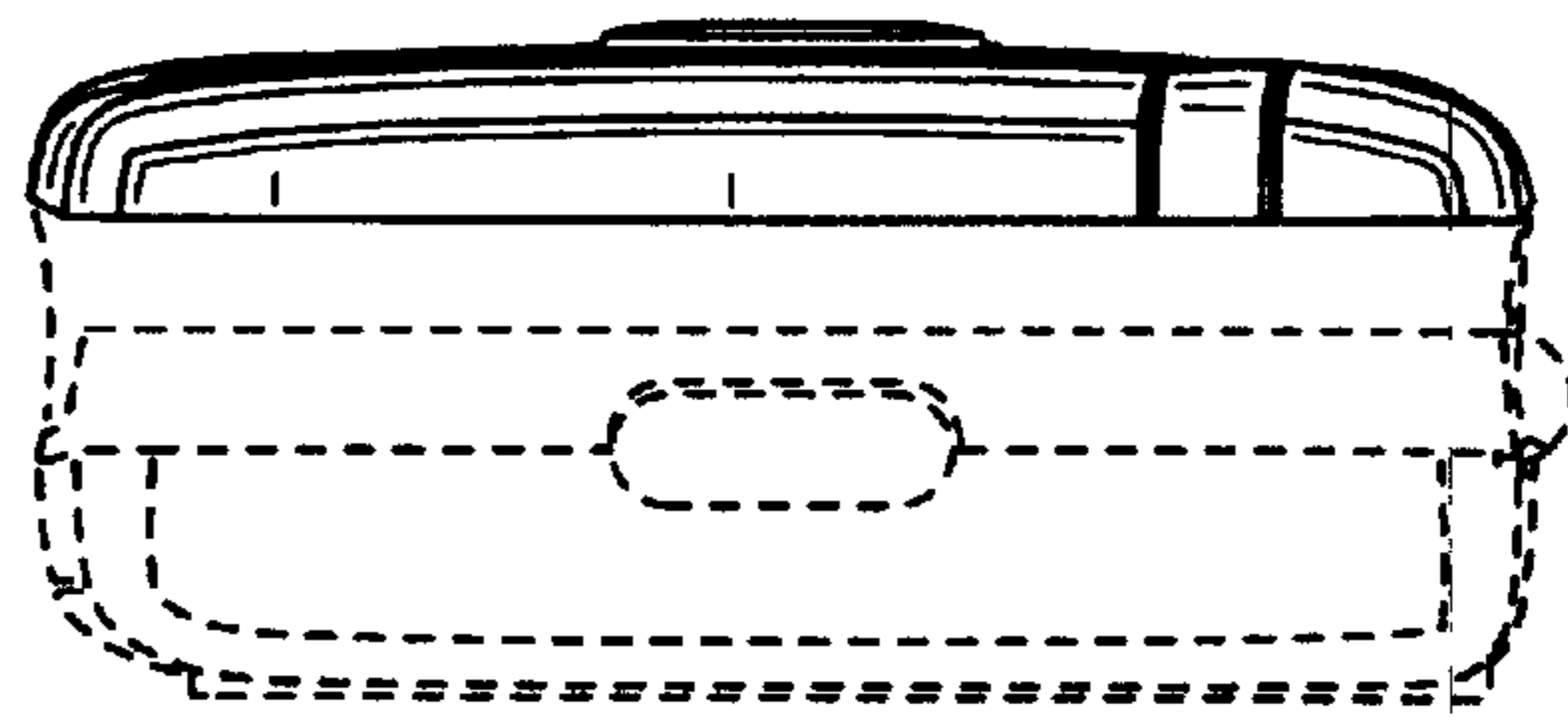

FIG. 5

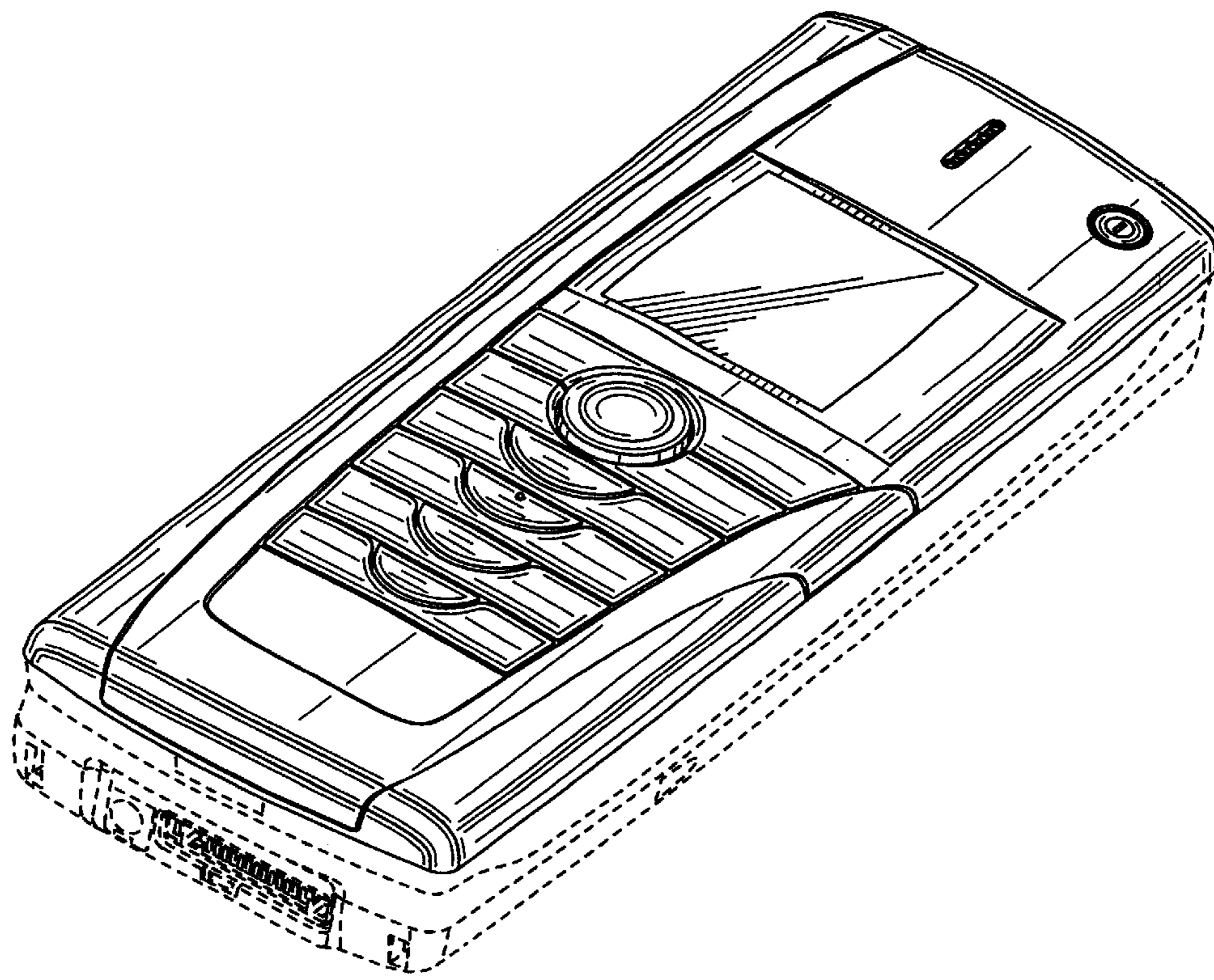

FIG. 6