



US00D537387S

(12) **United States Design Patent**
Tanaka et al.

(10) **Patent No.:** **US D537,387 S**

(45) **Date of Patent:** **** Feb. 27, 2007**

(54) **MOTORCYCLE**

D504,844 S * 5/2005 Sasanami D12/110

(75) Inventors: **Shunji Tanaka**, Kobe (JP); **Keishi Fukumoto**, Akashi (JP); **Takumi Uemoto**, Kobe (JP)

* cited by examiner

(73) Assignee: **Kawasaki Jukogyo Kabushiki Kaisha**, Hyogo (JP)

Primary Examiner—Alan P. Douglas

Assistant Examiner—Linda Brooks

(**) Term: **14 Years**

(57) **CLAIM**

The ornamental design for a motorcycle, as shown and described.

(21) Appl. No.: **29/254,435**

(22) Filed: **Feb. 23, 2006**

DESCRIPTION

(30) **Foreign Application Priority Data**

Aug. 26, 2005 (JP) 2005-024780

FIG. 1 is a front elevational view of a motorcycle showing our new design;

(51) **LOC (8) Cl.** **12-11**

FIG. 2 is a rear elevational view thereof;

(52) **U.S. Cl.** **D12/110**

FIG. 3 is a left side elevational view thereof;

(58) **Field of Classification Search** D12/110;
180/219, 220, 225, 229

FIG. 4 is a right side elevational view thereof;

See application file for complete search history.

FIG. 5 is a top plan view thereof; and,

FIG. 6 is a bottom plan view thereof.

(56) **References Cited**

U.S. PATENT DOCUMENTS

D350,920 S * 9/1994 Tsukui et al. D12/110

1 Claim, 3 Drawing Sheets

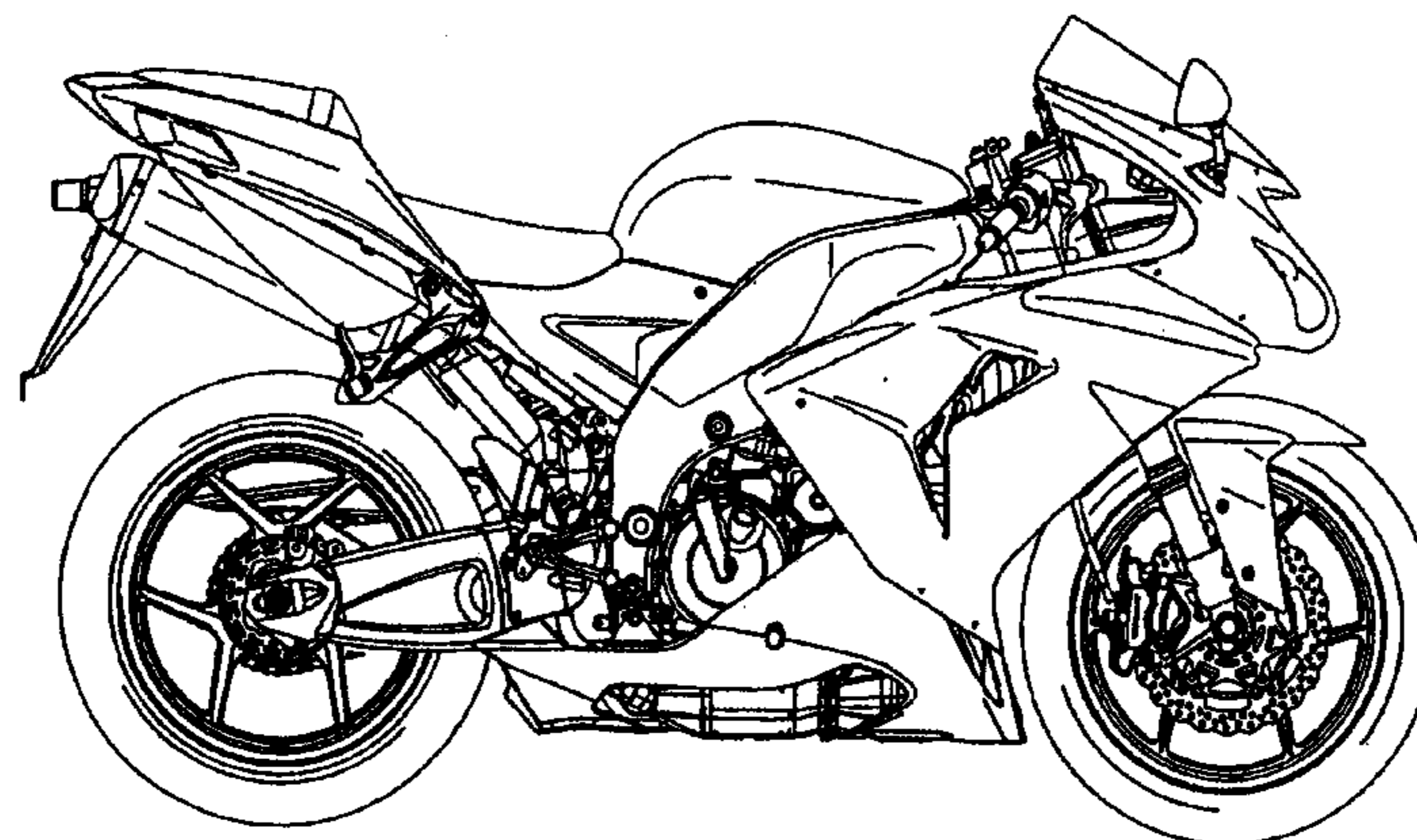
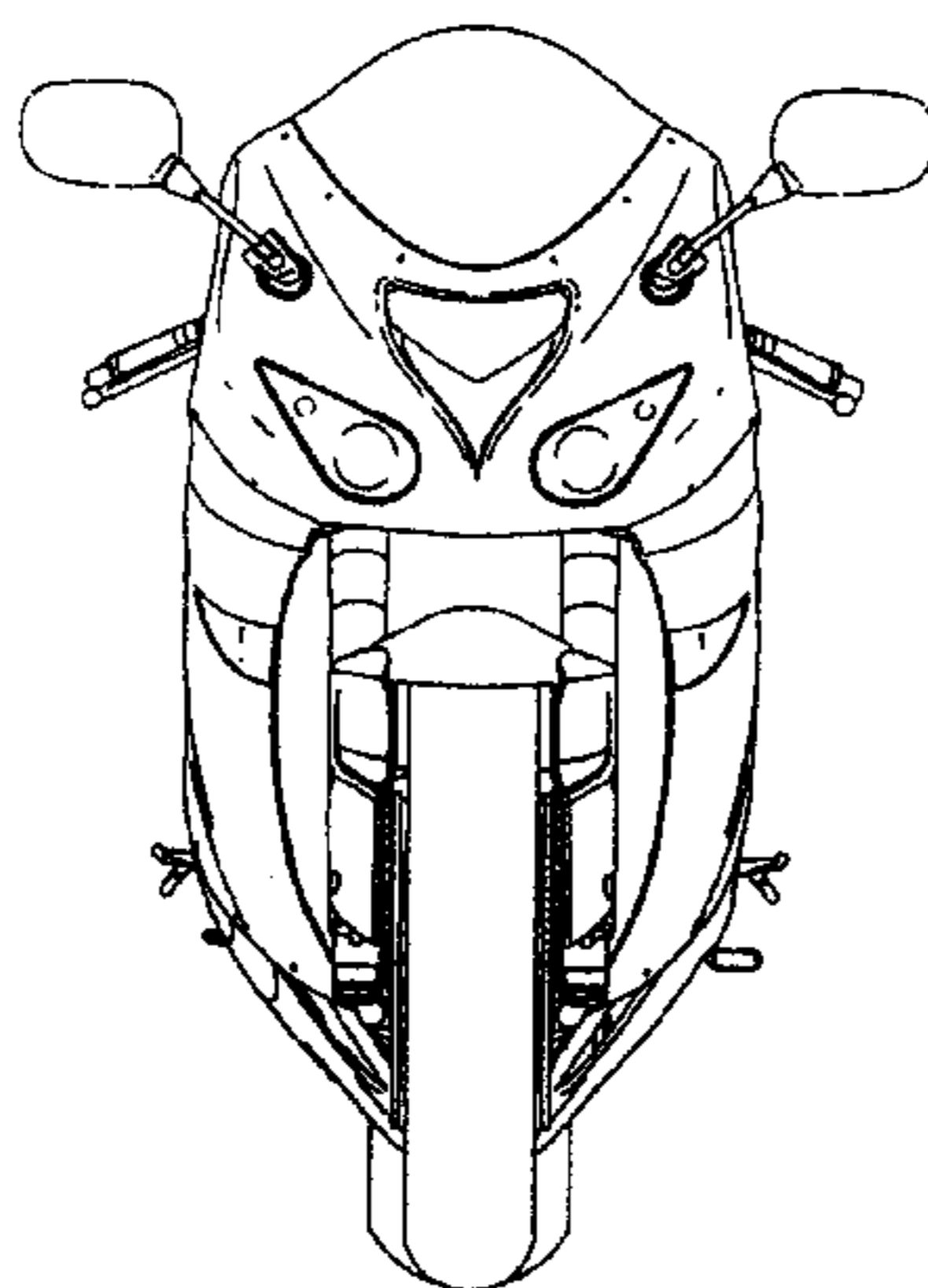

Fig. 1

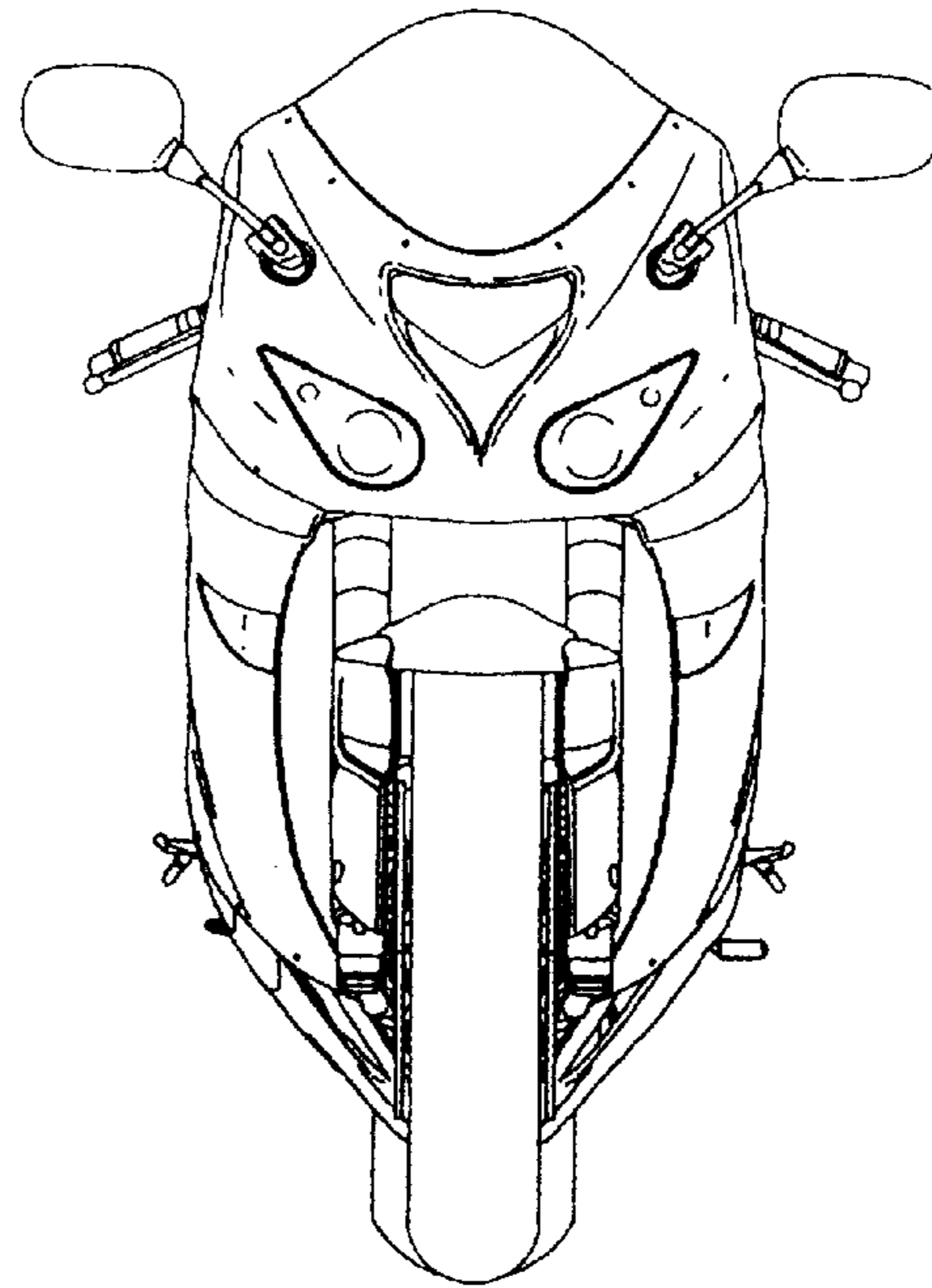

Fig. 2

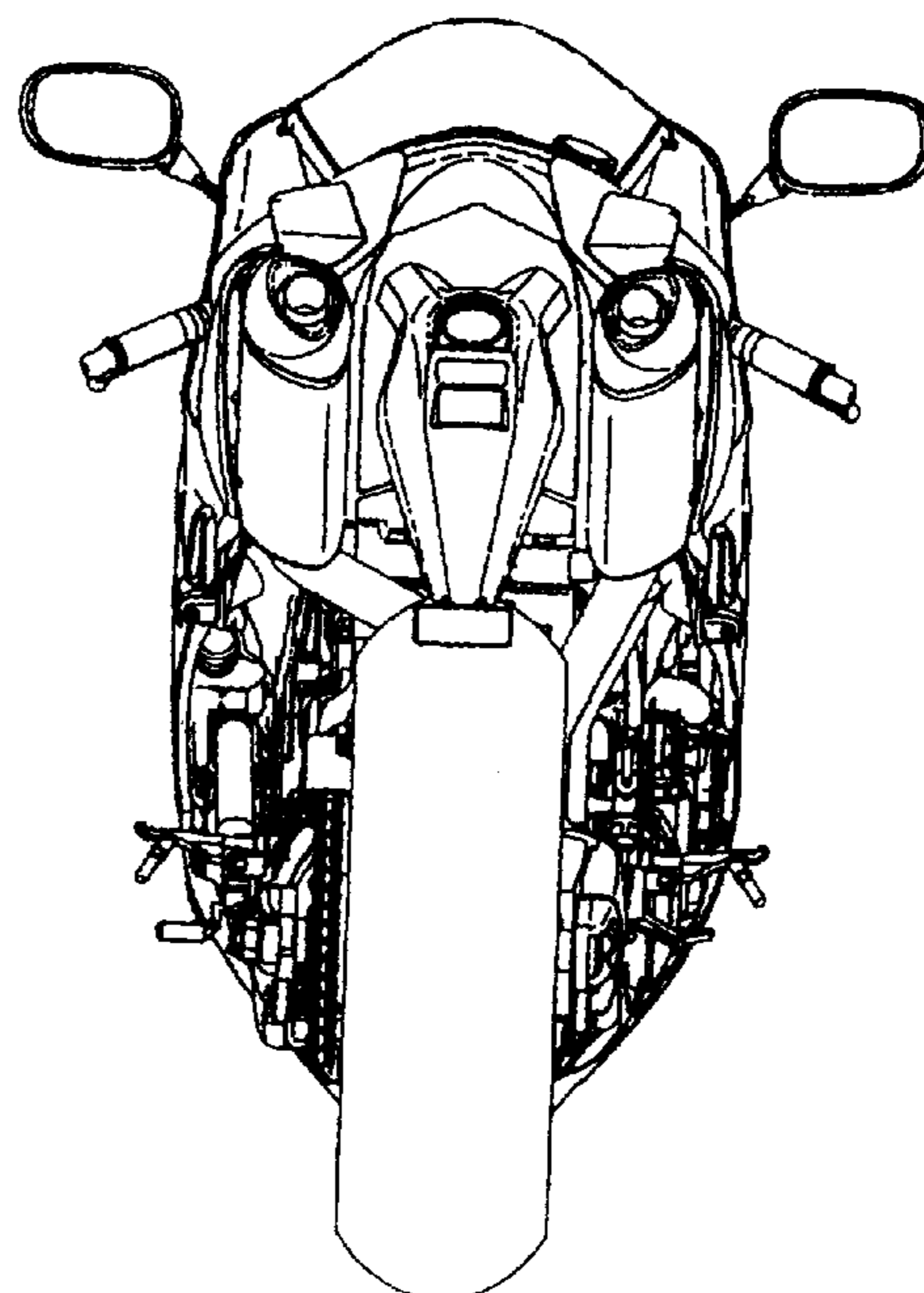

Fig. 3

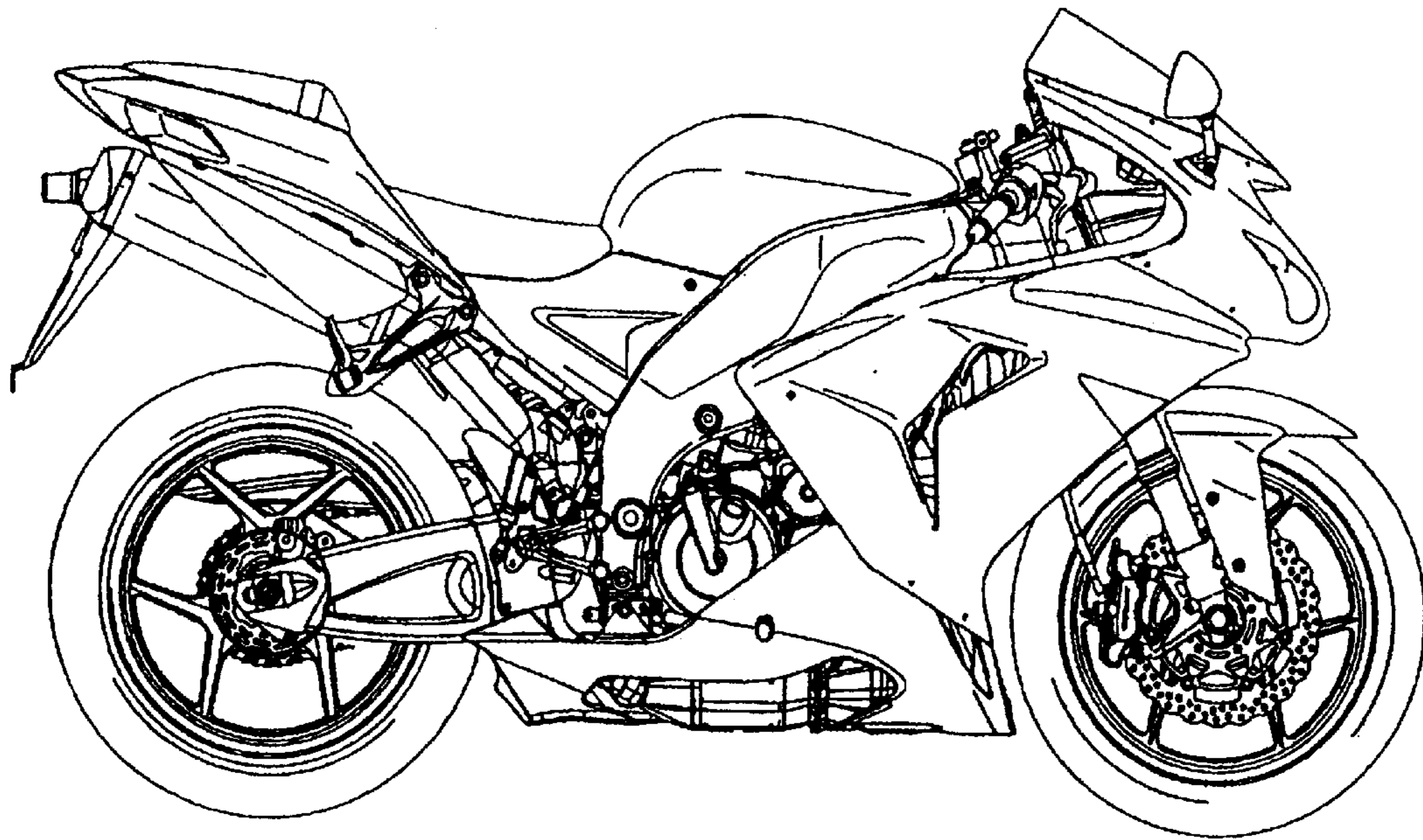

Fig. 4

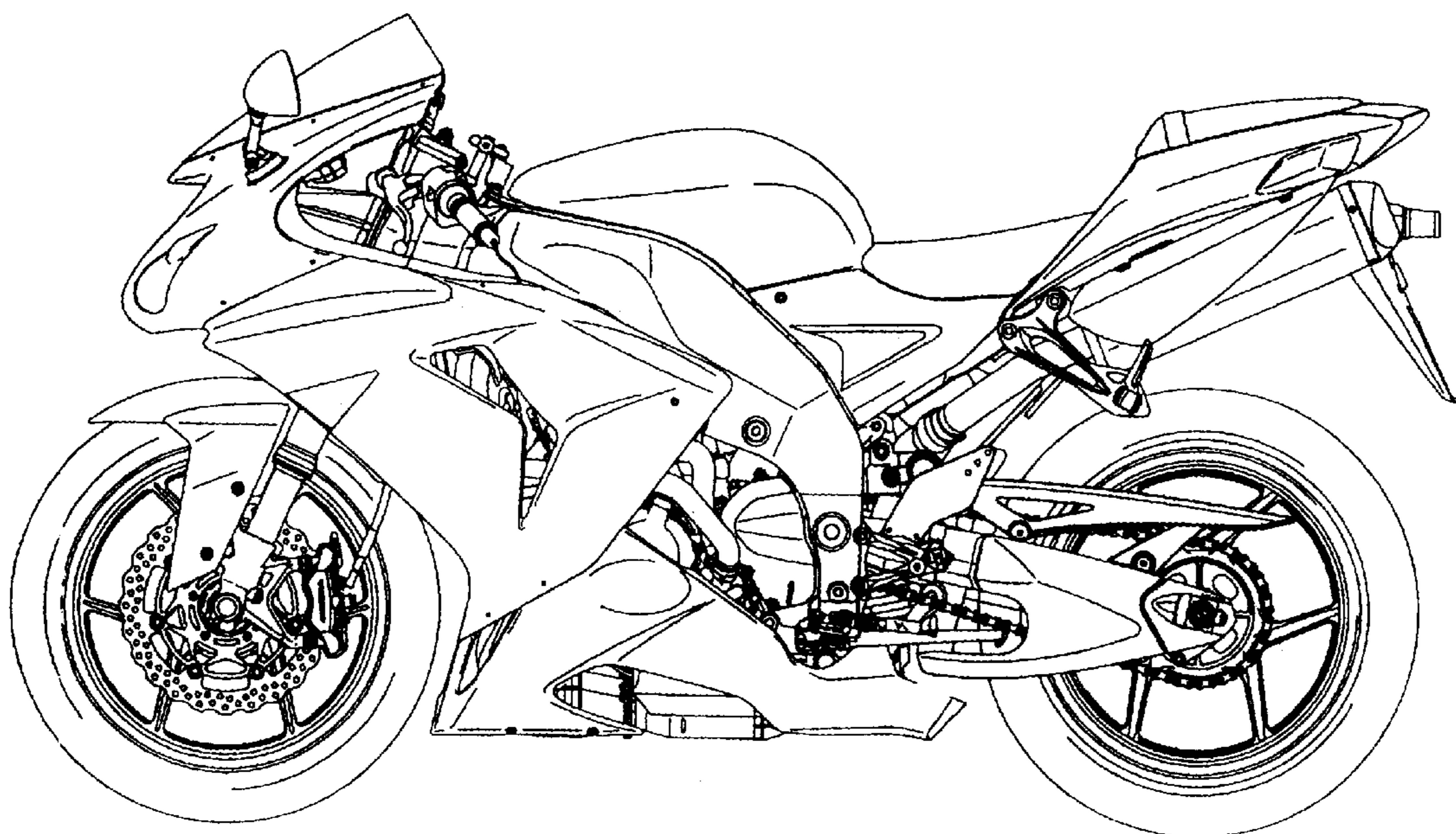

Fig. 5

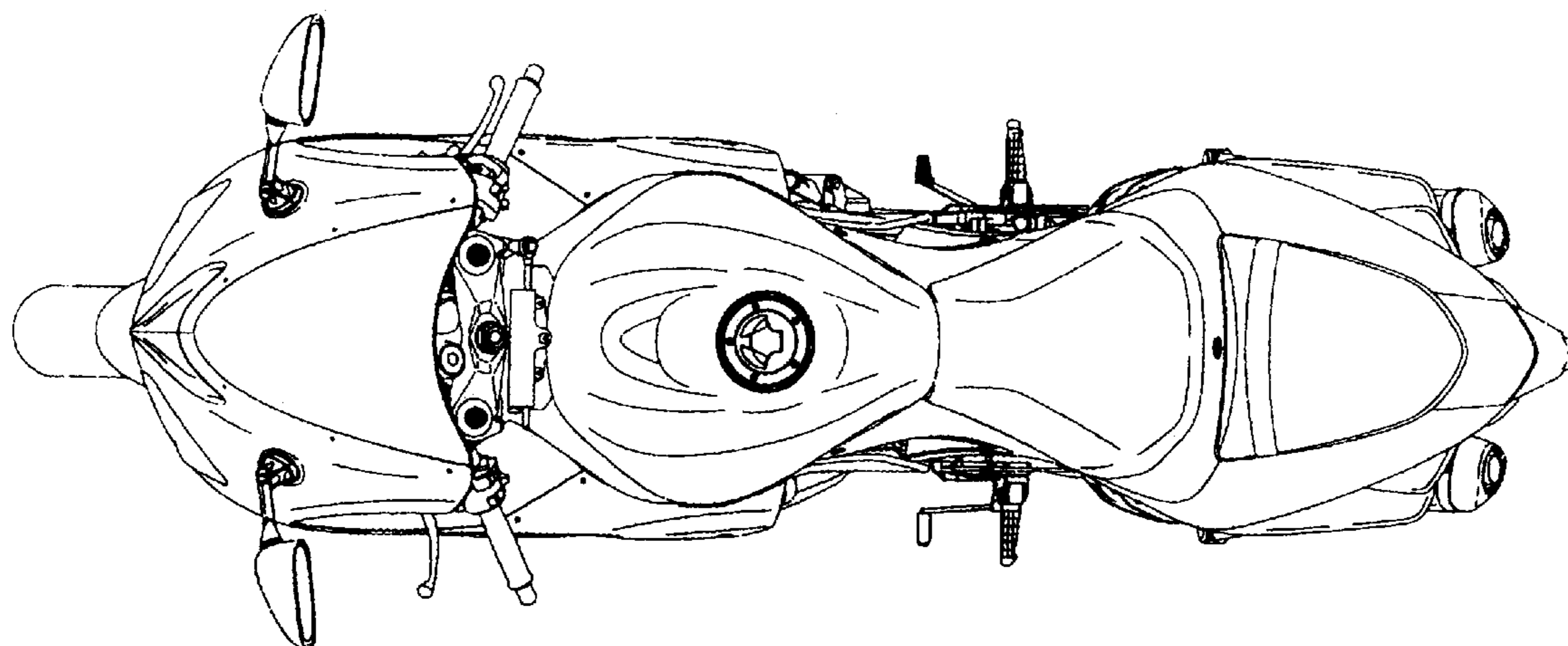

Fig. 6

