



US00D537277S

(12) **United States Design Patent**
Chen

(10) **Patent No.:** **US D537,277 S**

(45) **Date of Patent:** **** Feb. 27, 2007**

(54) **BABY CRIB**

6,859,957 B1 * 3/2005 Chen 5/93.1
6,954,949 B1 * 10/2005 Chen 5/99.1

(75) Inventor: **Shun-Min Chen**, Taipei (TW)

* cited by examiner

(73) Assignee: **Wonderland Nursery Goods Co., Ltd.**
(TW)

Primary Examiner—Janice E. Seeger

(74) *Attorney, Agent, or Firm*—DLA Piper US LLC

(**) Term: **14 Years**

(57) **CLAIM**

(21) Appl. No.: **29/218,625**

The ornamental design for baby crib, as shown and described.

(22) Filed: **Dec. 3, 2004**

DESCRIPTION

(51) **LOC (8) Cl.** **06-06**

(52) **U.S. Cl.** **D6/499; D6/503; D6/331**

(58) **Field of Classification Search** D6/390,
D6/391, 331, 333, 508, 383, 384, 503; 5/93.1,
5/93.2, 99.1, 101, 97, 98.1, 655
See application file for complete search history.

FIG. 1 is a perspective view of baby crib showing my new design;

FIG. 2 is a front elevational view thereof;

FIG. 3 is a rear elevational view thereof;

FIG. 4 is a left side elevational view thereof;

FIG. 5 is a right side elevational view thereof;

FIG. 6 is a top plan view thereof; and,

FIG. 7 is a bottom plan view thereof.

The broken lines are for environmental purposes only and form no part of the claimed design.

(56) **References Cited**

U.S. PATENT DOCUMENTS

D448,218 S * 9/2001 Celestina-Krevh D6/495

D494,393 S * 8/2004 Chen D6/503

1 Claim, 7 Drawing Sheets

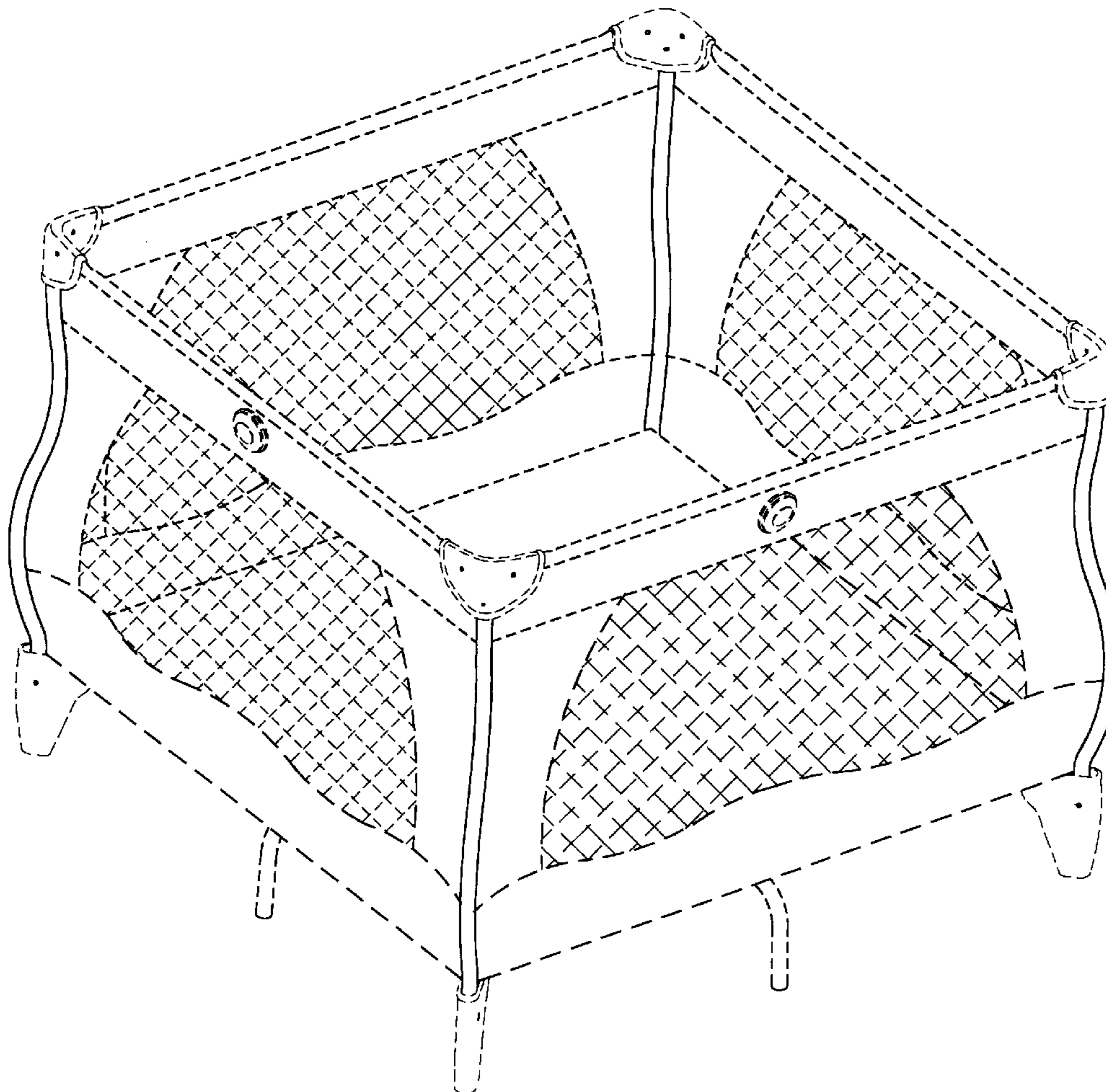

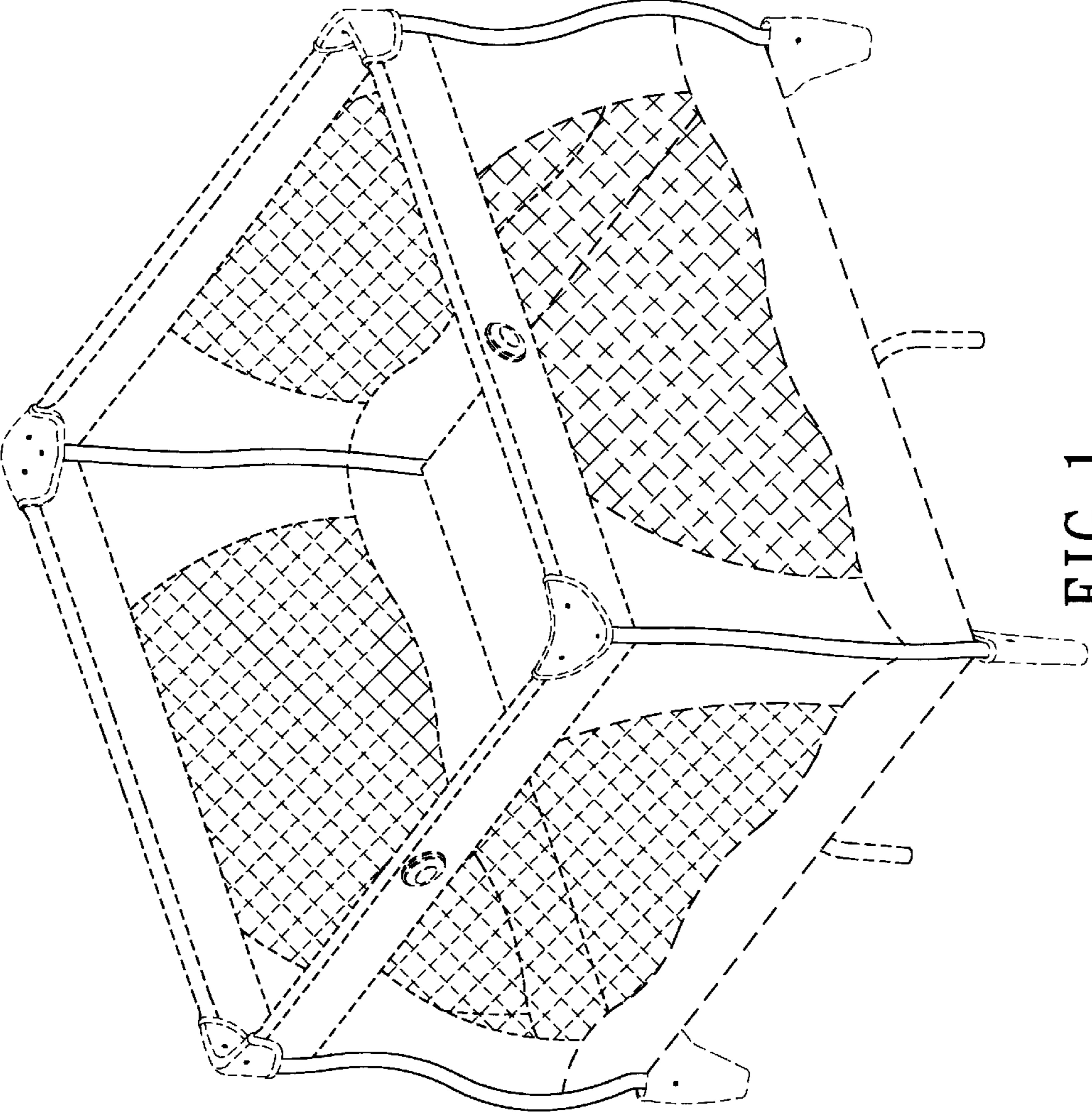

FIG. 1

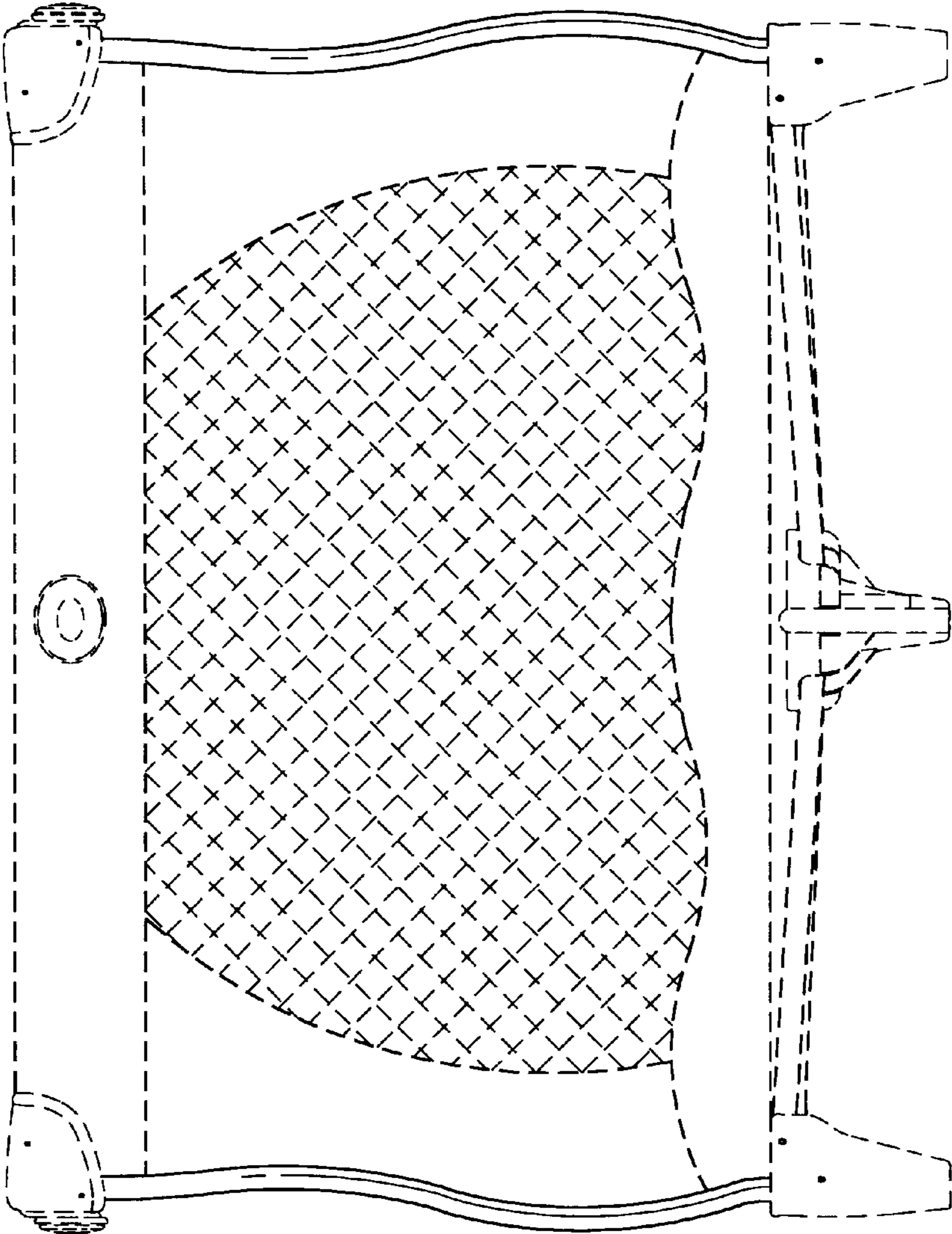

FIG. 2

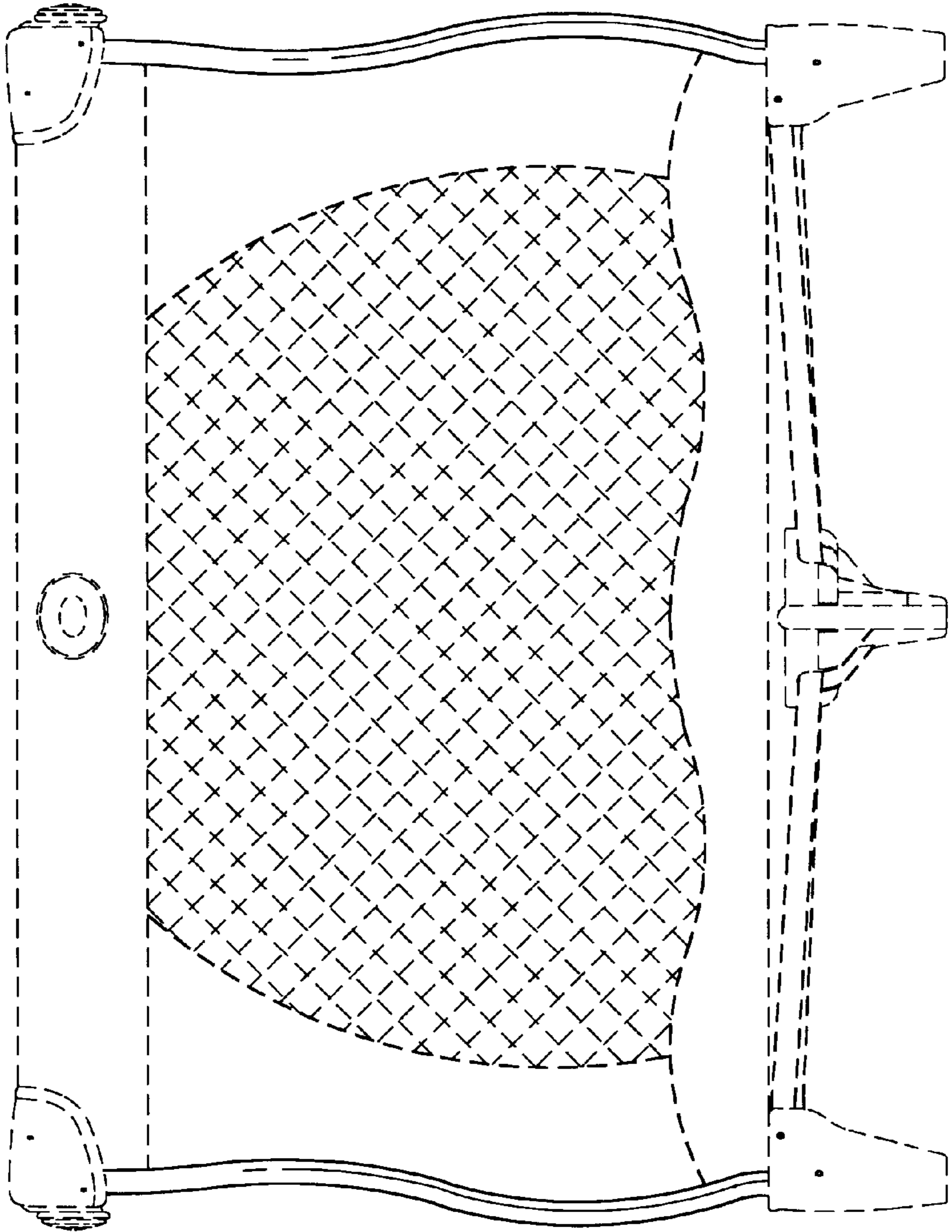

FIG. 3

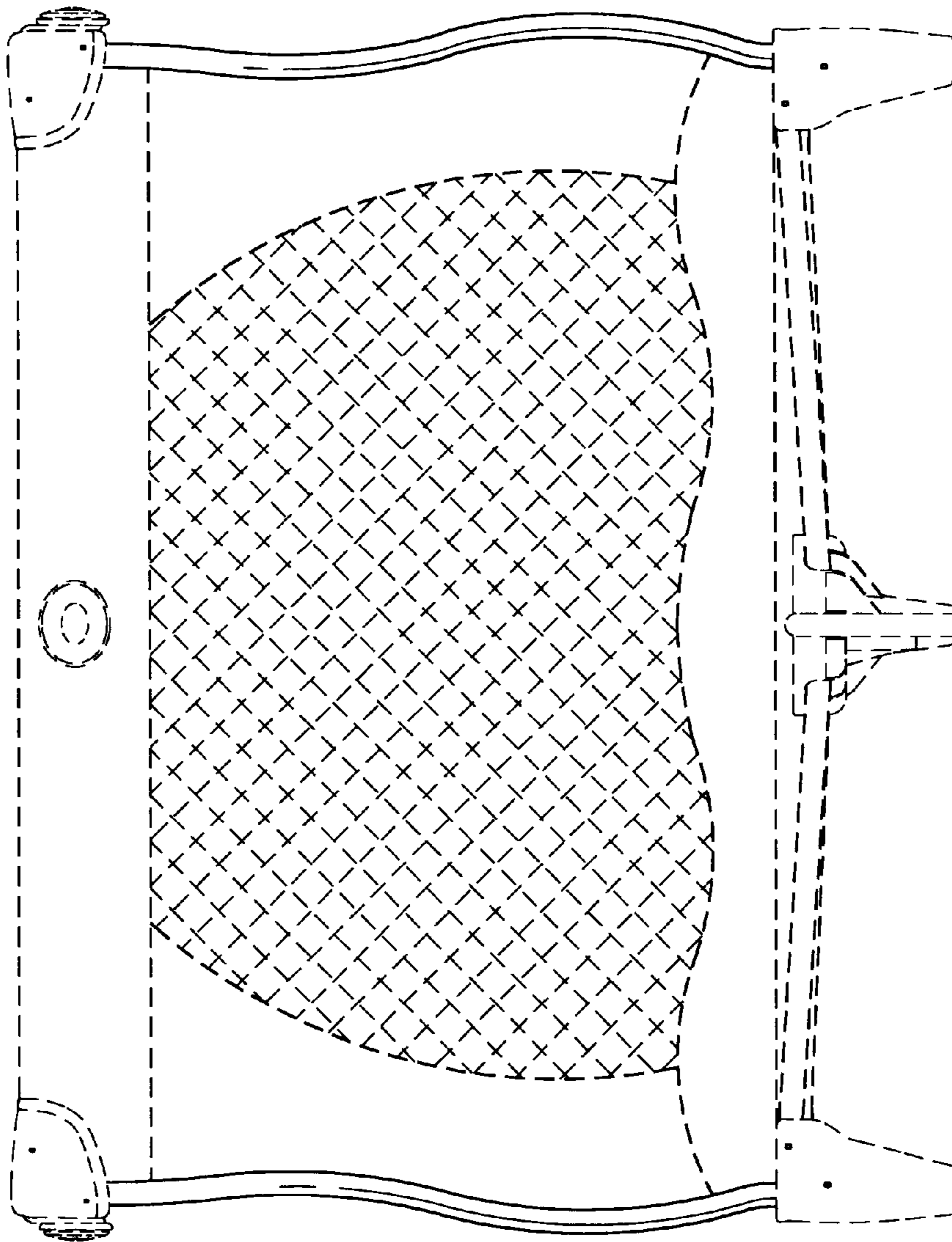

FIG. 4

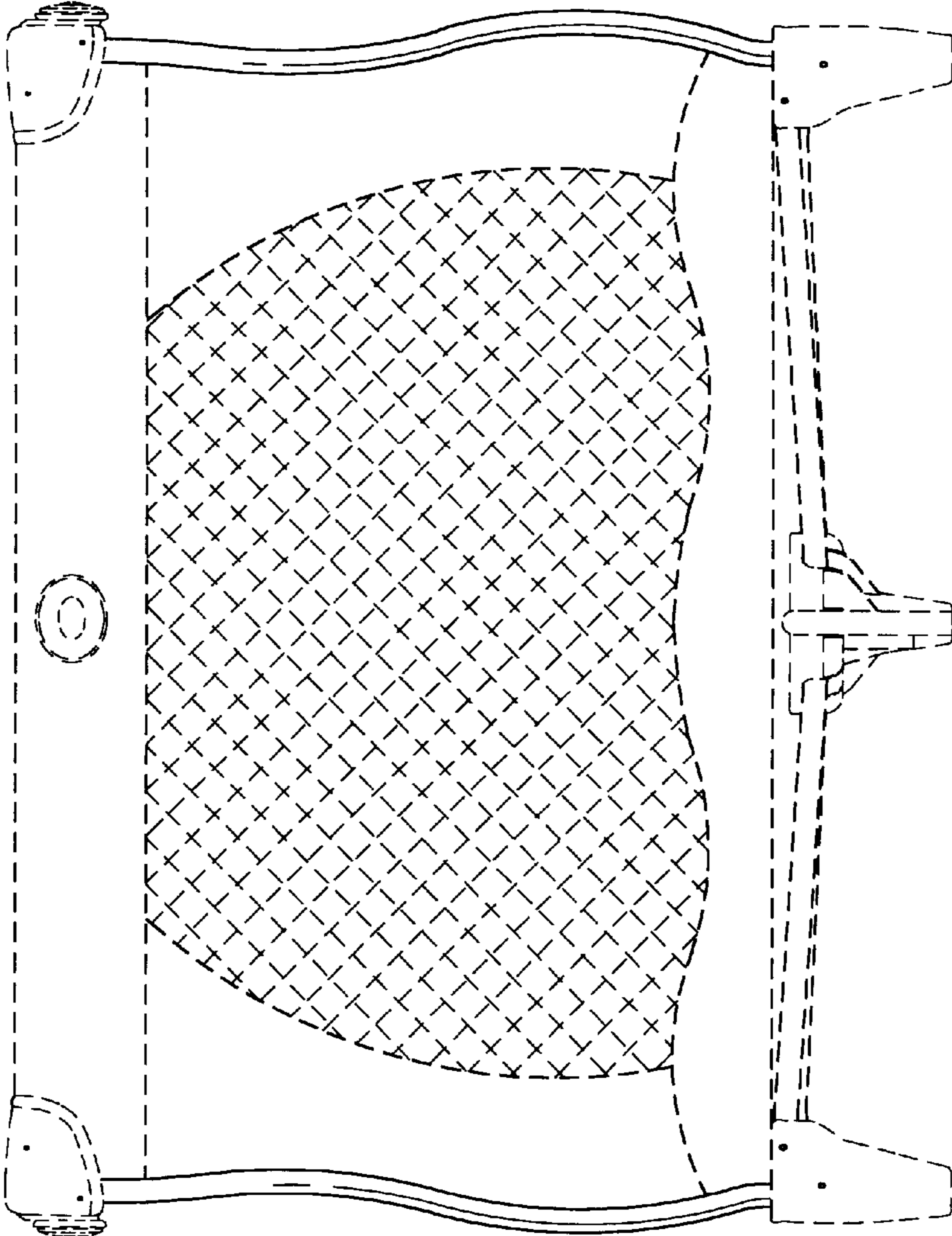

FIG. 5

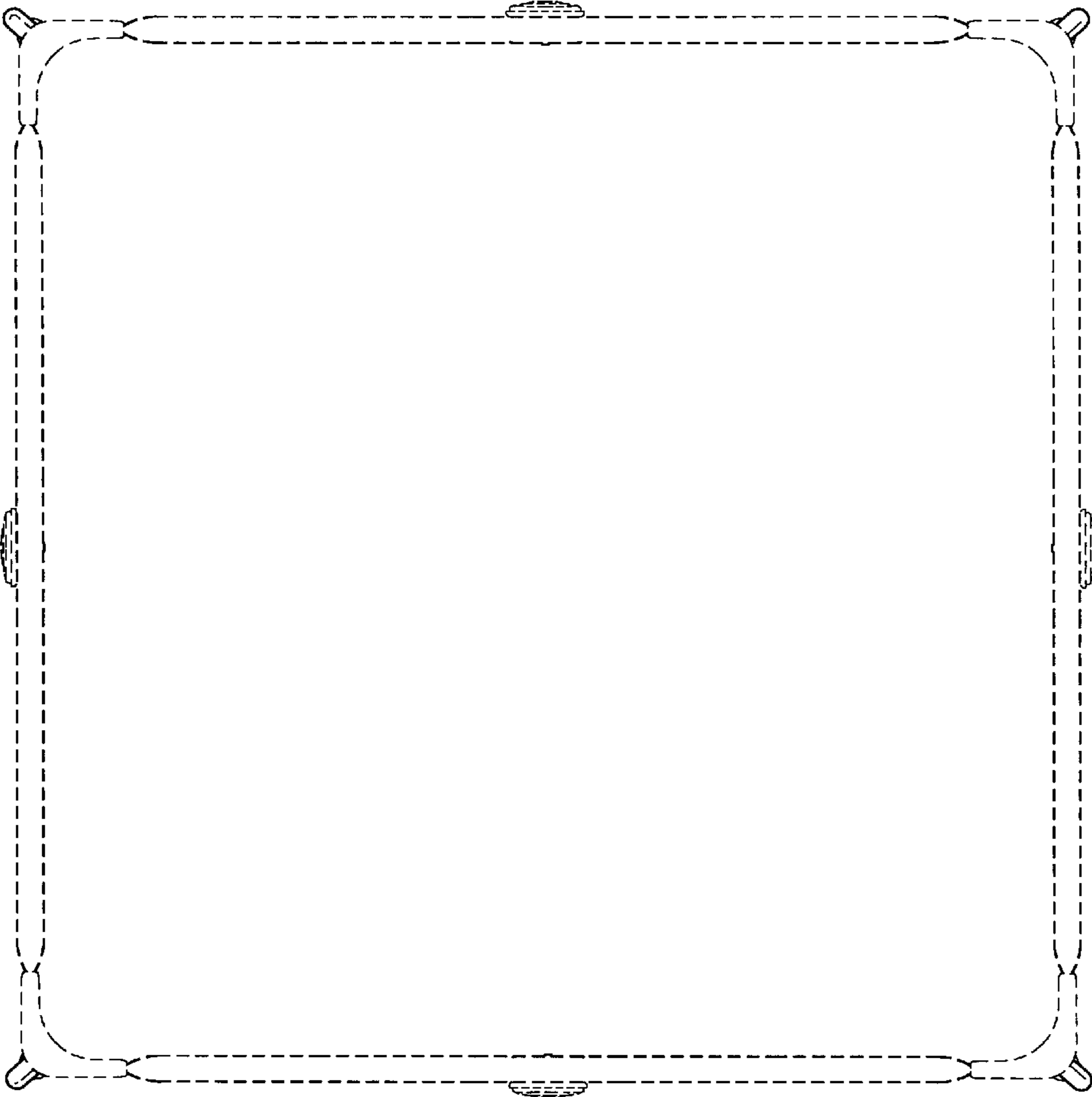

FIG. 6

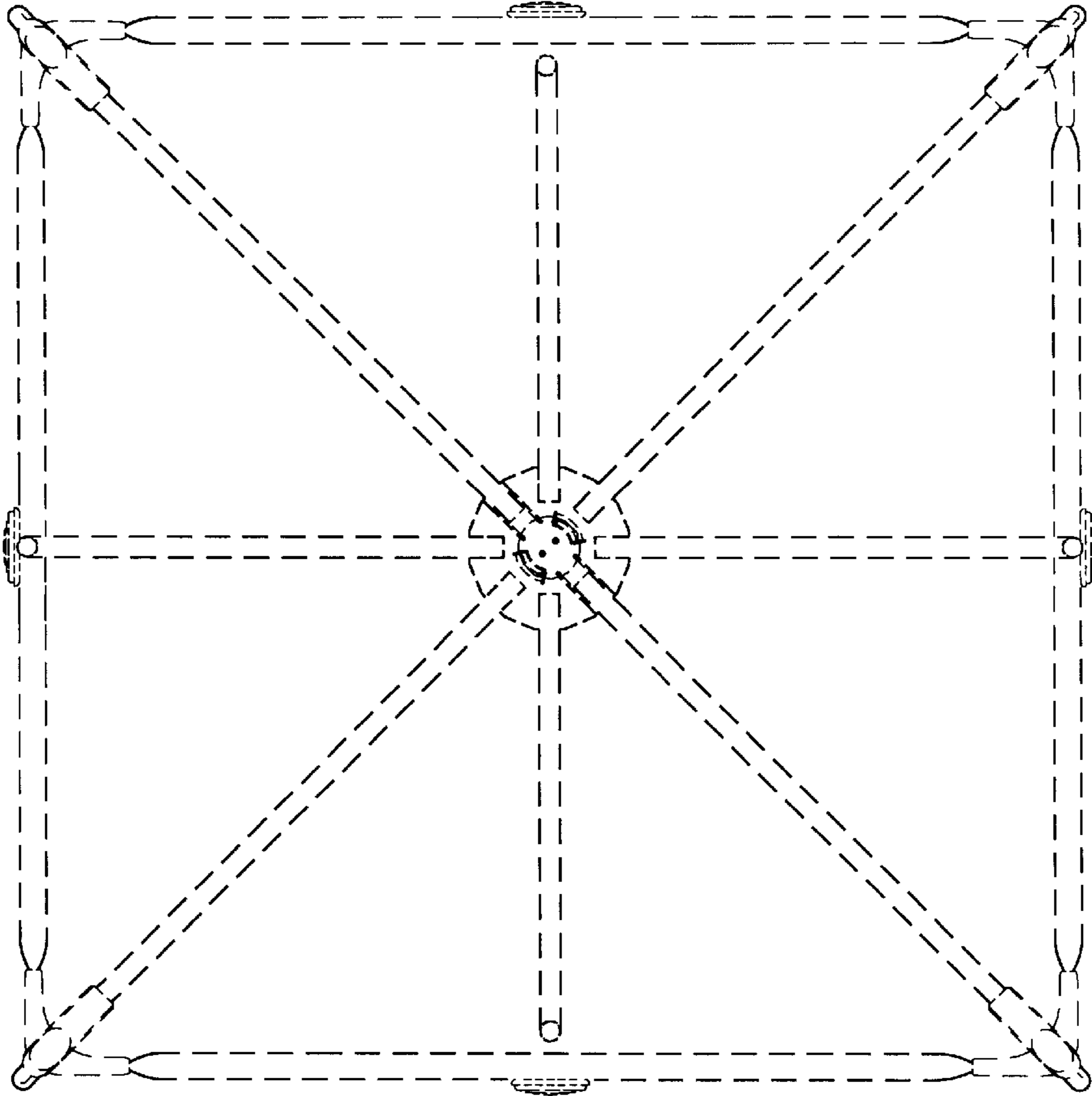

FIG. 7