



US00D537198S

(12) **United States Design Patent**
Chuang

(10) **Patent No.:** **US D537,198 S**

(45) **Date of Patent:** **** Feb. 20, 2007**

(54) **LIGHTER**

(76) Inventor: **Shao Chi Chuang**, No. 13, Alley 41,
Lane 8, Tianmu East Road, Taipei City
(TW)

(**) Term: **14 Years**

(21) Appl. No.: **29/247,469**

(22) Filed: **Jun. 20, 2006**

(51) **LOC (8) Cl.** **27-05**

(52) **U.S. Cl.** **D27/143; D27/157**

(58) **Field of Classification Search** D27/141-161;
431/129, 143, 153, 253-256, 273-277; 30/109-113;
131/248, 249

See application file for complete search history.

(56) **References Cited**

U.S. PATENT DOCUMENTS

D435,933 S * 1/2001 Chen D27/141
D454,224 S * 3/2002 Park D27/157

D515,735 S * 2/2006 Smith D27/157

* cited by examiner

Primary Examiner—Jennifer Rivard

(74) *Attorney, Agent, or Firm*—Banger Shia

(57) **CLAIM**

The ornamental design for a lighter, as shown and described.

DESCRIPTION

FIG. 1 is a perspective view of a lighter showing my new design;

FIG. 2 is a front elevational view thereof;

FIG. 3 is a rear elevational view thereof,

FIG. 4 is a left side elevational view thereof,

FIG. 5 is a right side elevational view thereof,

FIG. 6 is a top plan view thereof; and

FIG. 7 is a bottom plan view to that shown; and,

FIG. 8 is a perspective view of showing the open condition of the claimed design.

1 Claim, 6 Drawing Sheets

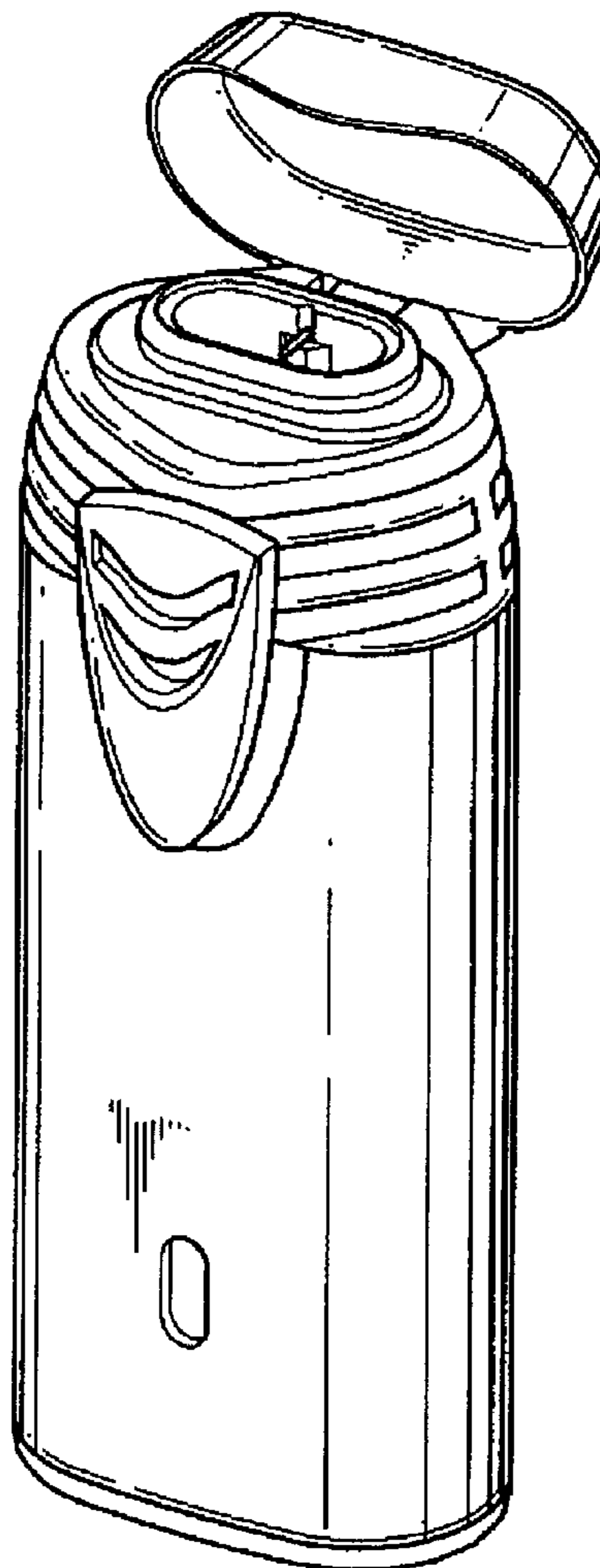
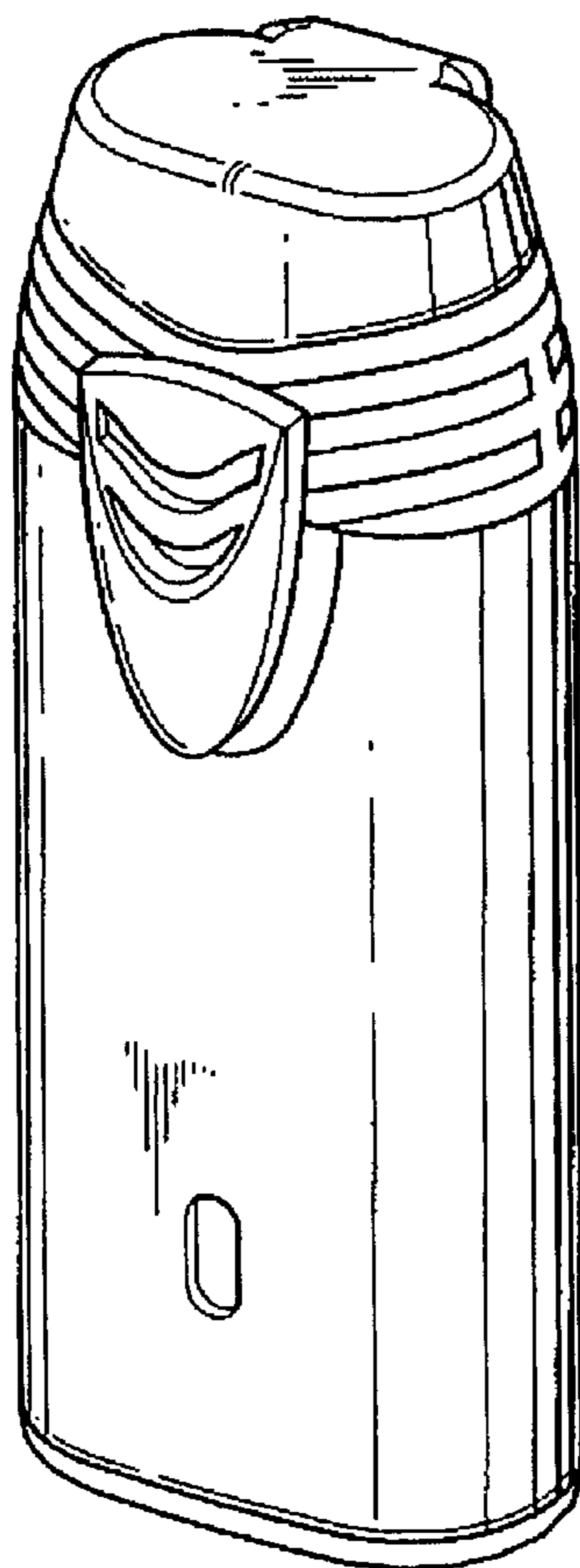

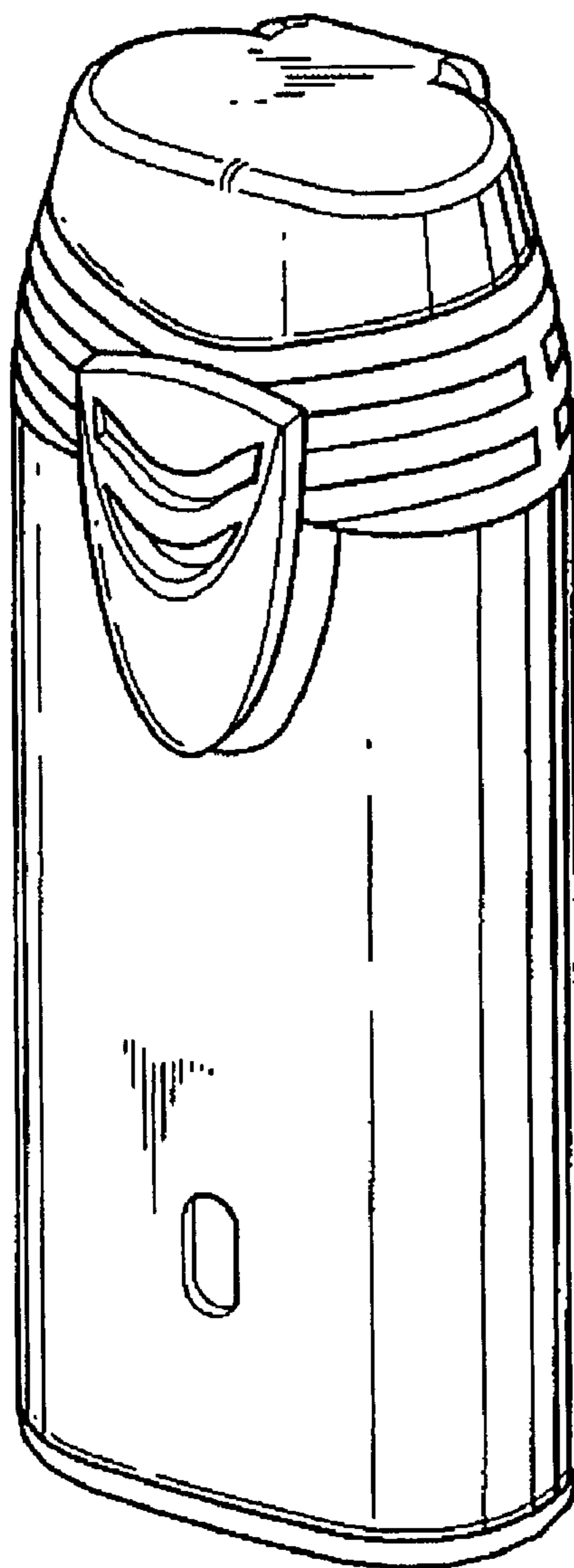

FIG. 1

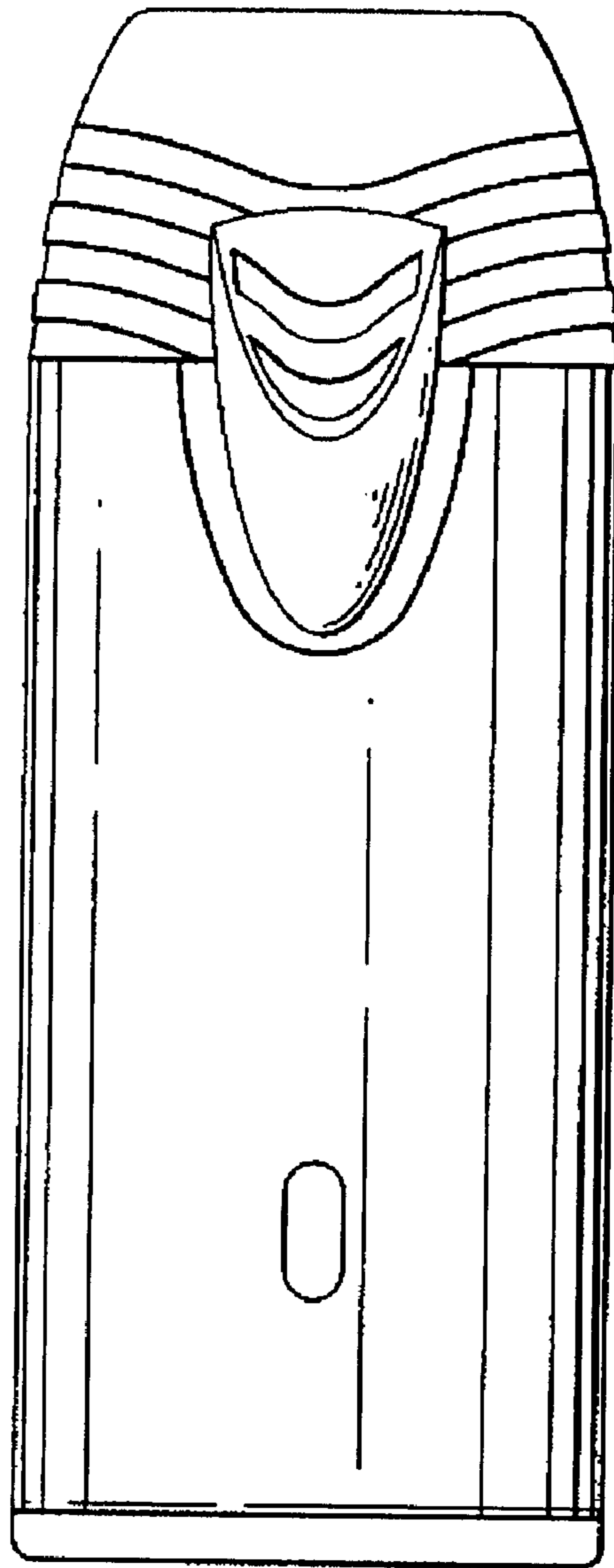

FIG. 2

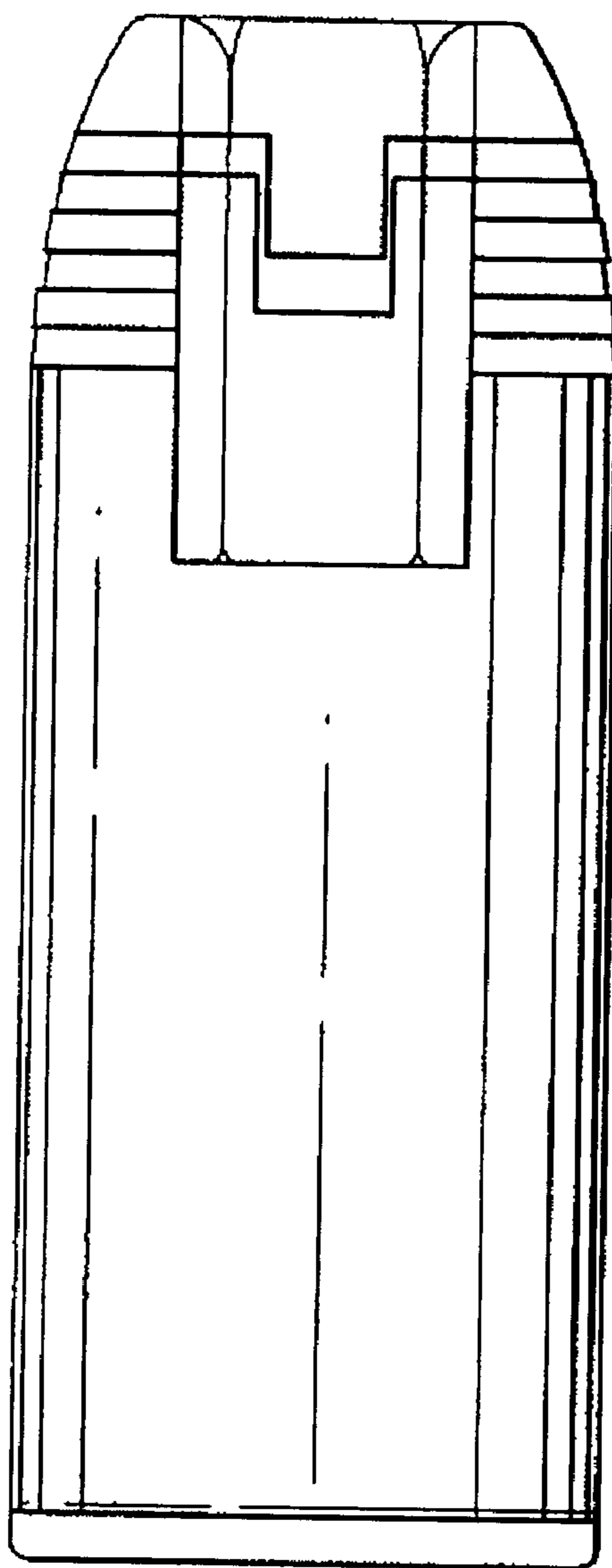

FIG. 3

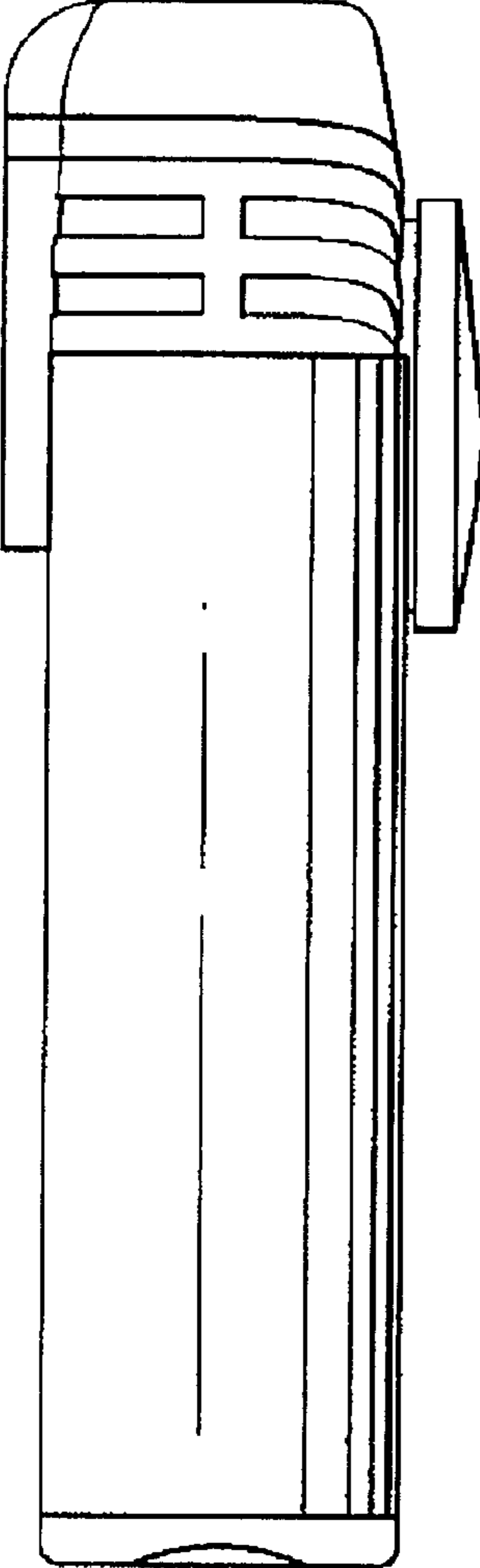

FIG. 4

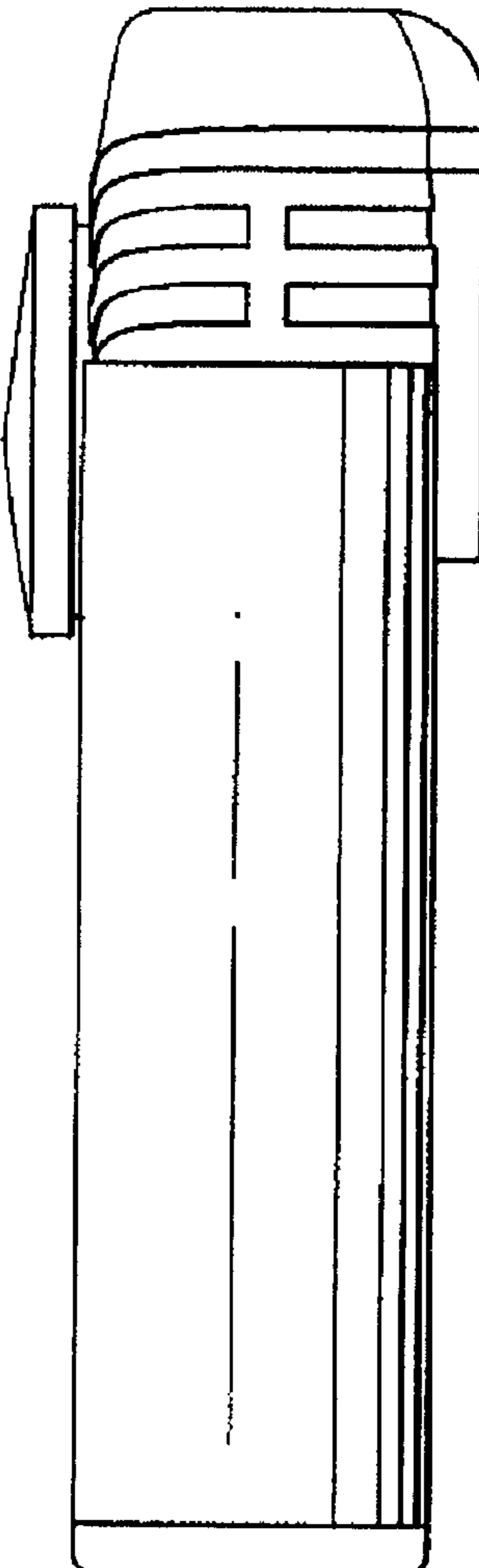

FIG. 5

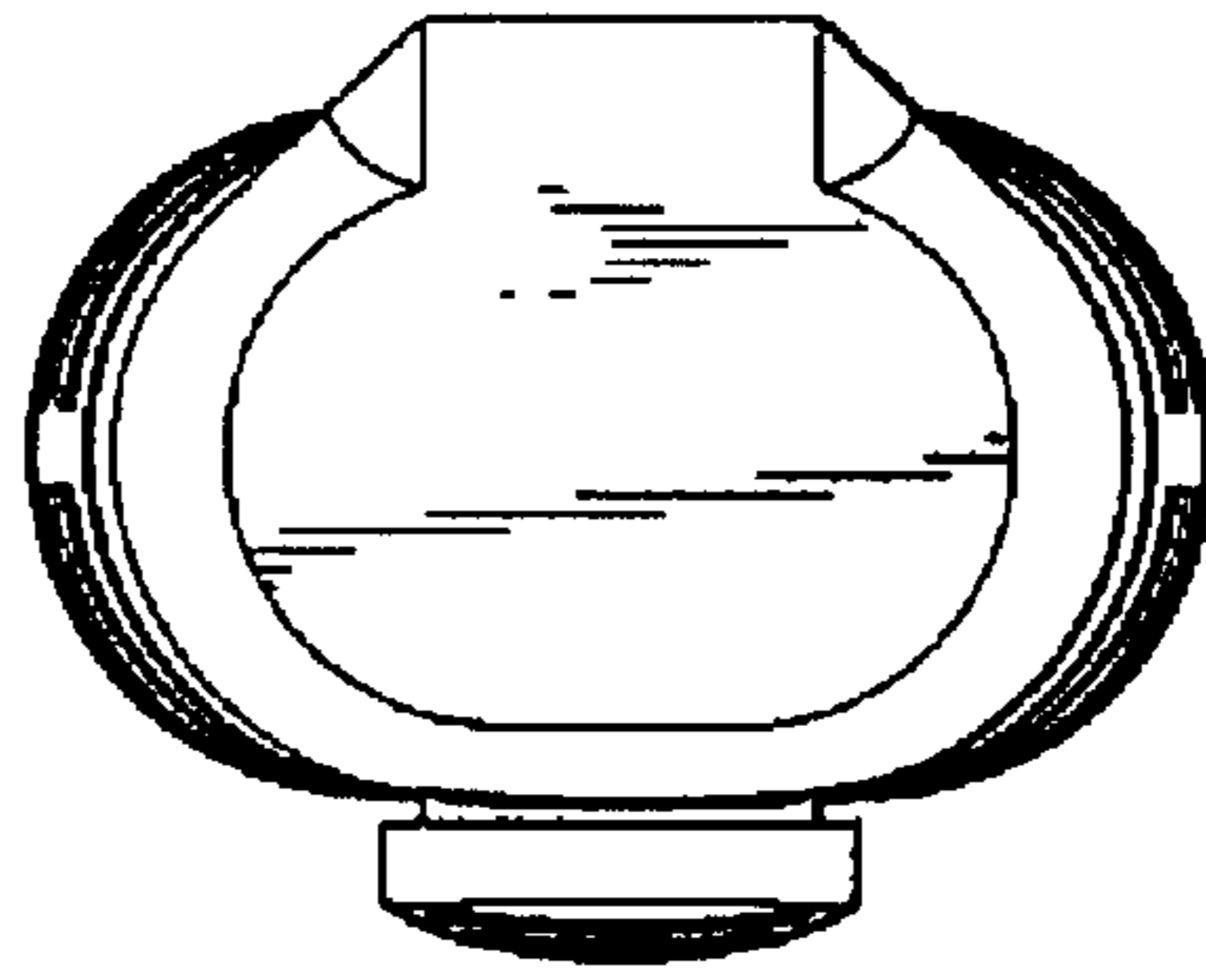

FIG. 6

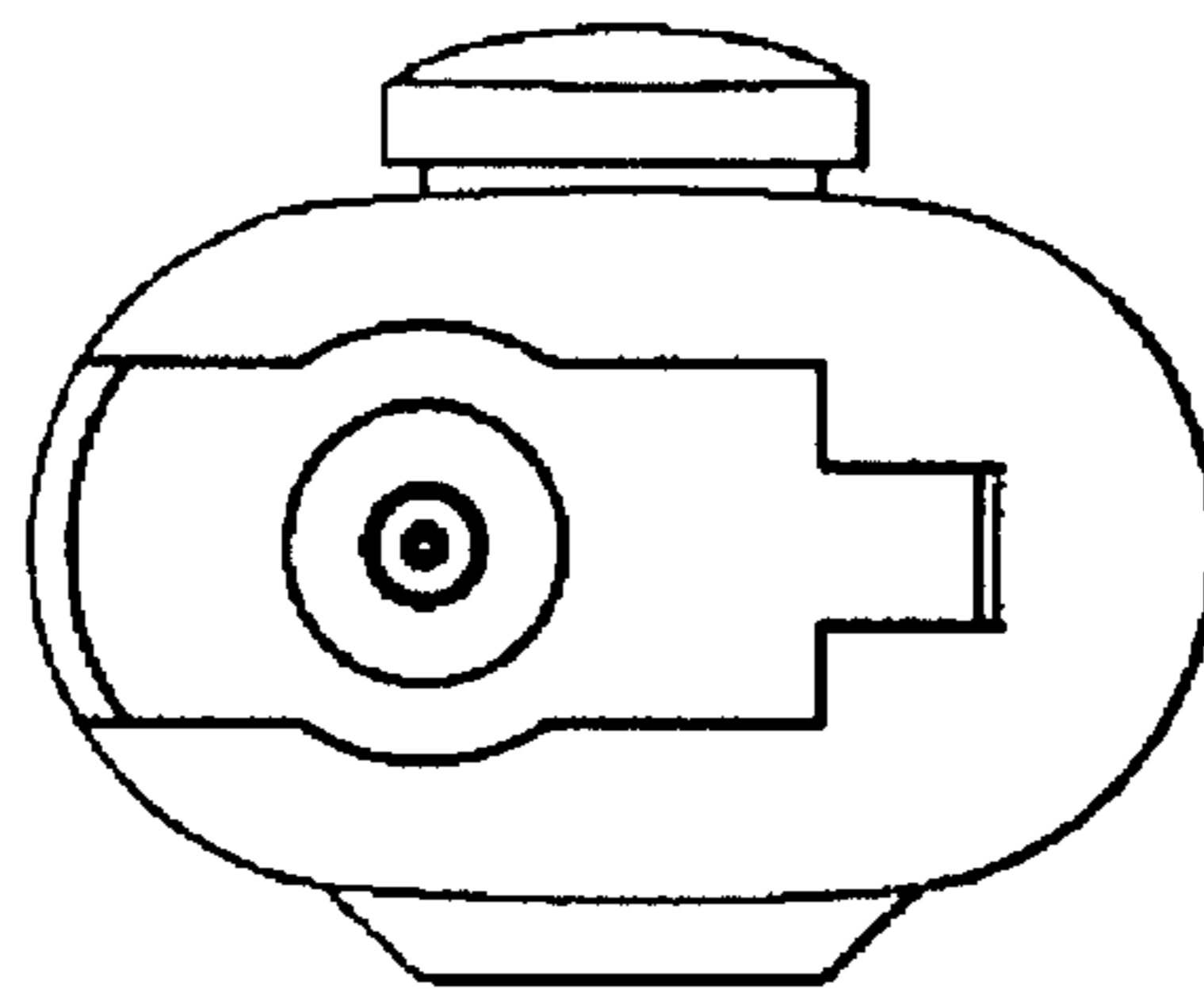

FIG. 7

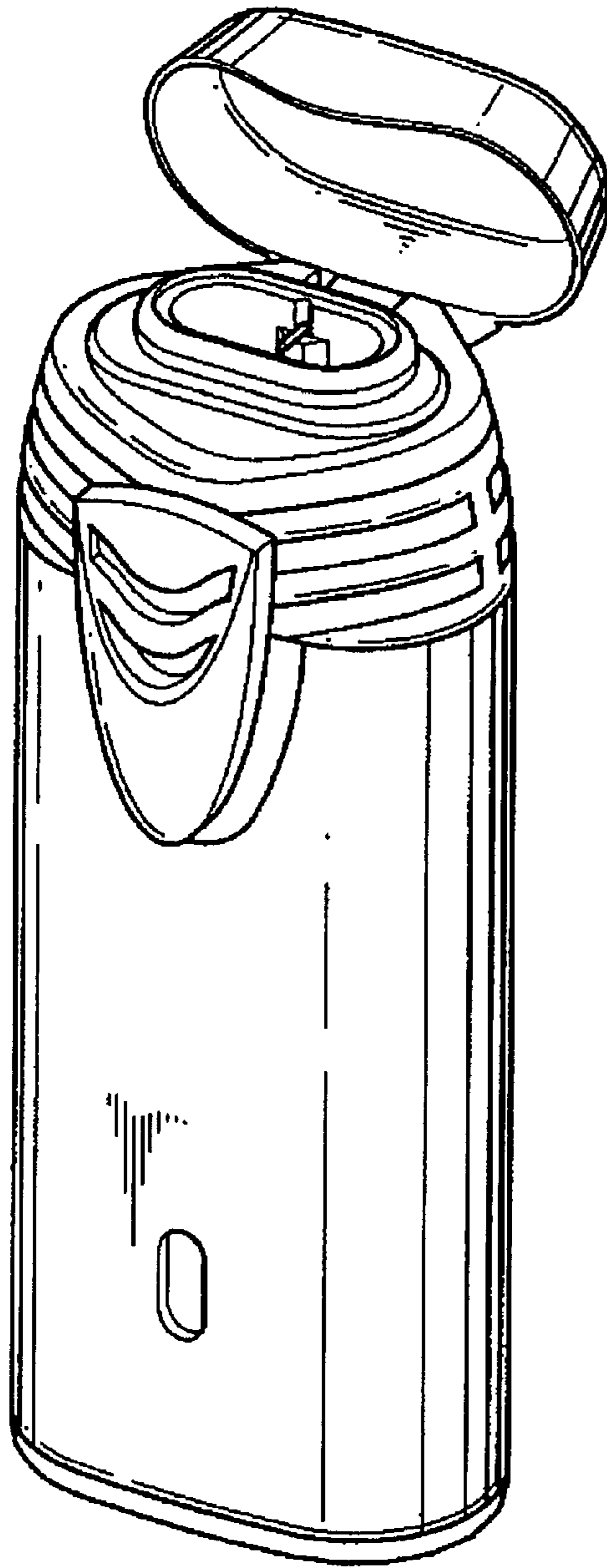

FIG. 8