



US00D537068S

(12) **United States Design Patent**
Kim et al.

(10) **Patent No.:** **US D537,068 S**

(45) **Date of Patent:** **** Feb. 20, 2007**

(54) **HEADSET**

(75) Inventors: **Young-Soo Kim**, Goyang-si (KR);
Beom-Ku Han, Seoul (KR);
Chang-Hwan Hwang, Goyang-si (KR)

(73) Assignee: **Samsung Electronics Co., Ltd.**,
Suwon-Si (KR)

(**) Term: **14 Years**

(21) Appl. No.: **29/245,733**

(22) Filed: **Dec. 29, 2005**

(30) **Foreign Application Priority Data**

Jul. 22, 2005 (KR) 30-2005-0024820

(51) **LOC (8) Cl.** **14-01**

(52) **U.S. Cl.** **D14/205**

(58) **Field of Classification Search** D14/192,
D14/205, 206, 223; D24/173, 174; 181/128,
181/129, 130, 135; 381/187, 330, 370, 374,
381/376, 377, 379, 378, 380, 381, 385; 379/430,
379/433, 446; 455/351

See application file for complete search history.

(56) **References Cited**

U.S. PATENT DOCUMENTS

1,587,643 A * 6/1926 Harman 181/135

D272,904 S * 3/1984 Kawano D14/205
4,453,050 A * 6/1984 Enokido 381/381
D284,859 S * 7/1986 Okada D14/192
D326,653 S * 6/1992 Hino D14/192
5,655,026 A * 8/1997 Peters et al. 381/385
D478,067 S * 8/2003 Kawakami et al. D14/223
6,771,790 B2 * 8/2004 Liu 381/385
D506,461 S * 6/2005 Han et al. D14/205

* cited by examiner

Primary Examiner—Paula A. Greene

(74) *Attorney, Agent, or Firm*—Staas & Halsey LLP

(57) **CLAIM**

The ornamental design for the headset, as shown and described.

DESCRIPTION

FIG. 1 is a perspective view of the headset showing our design;

FIG. 2 is a front view thereof;

FIG. 3 is a rear view thereof;

FIG. 4 is a left side view thereof;

FIG. 5 is a right side view thereof;

FIG. 6 is a top plan view thereof; and,

FIG. 7 is a bottom plan view thereof.

1 Claim, 3 Drawing Sheets

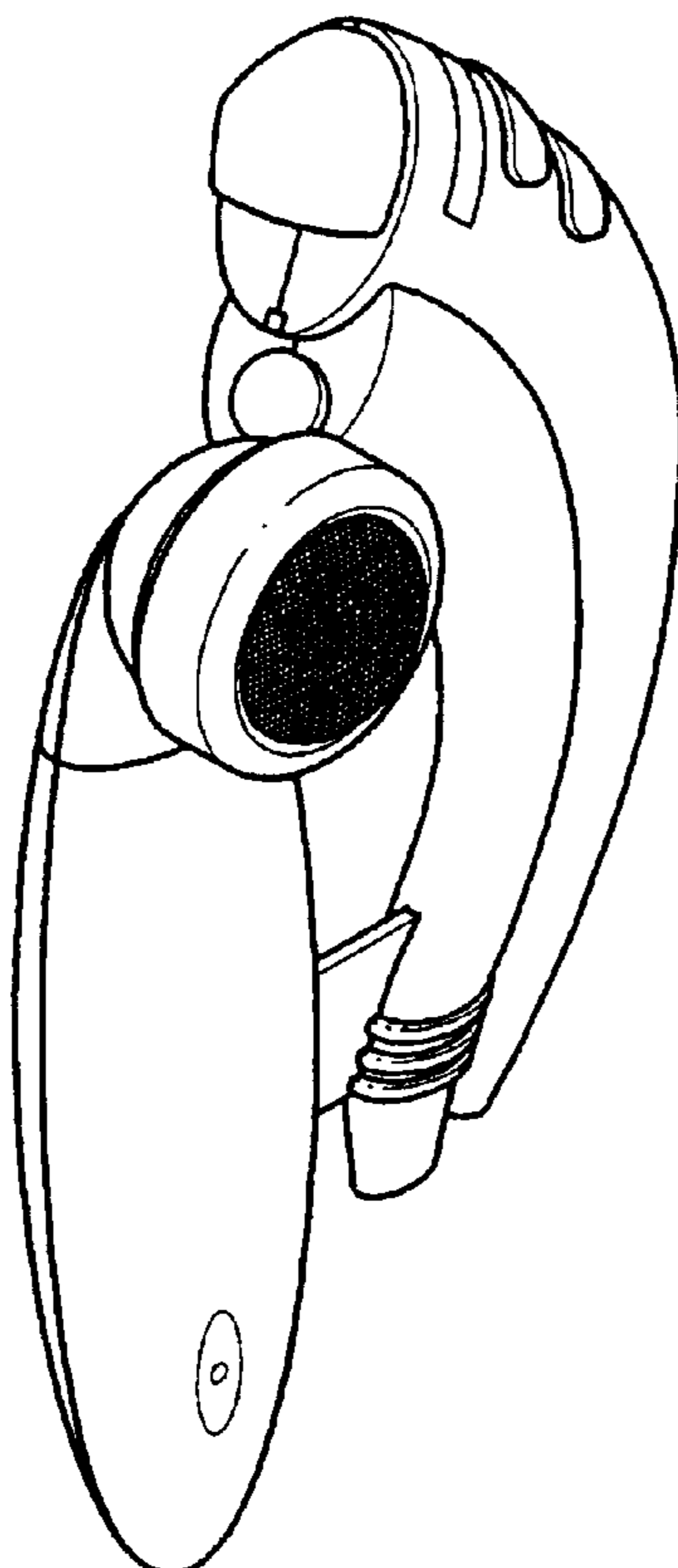

FIG. 1

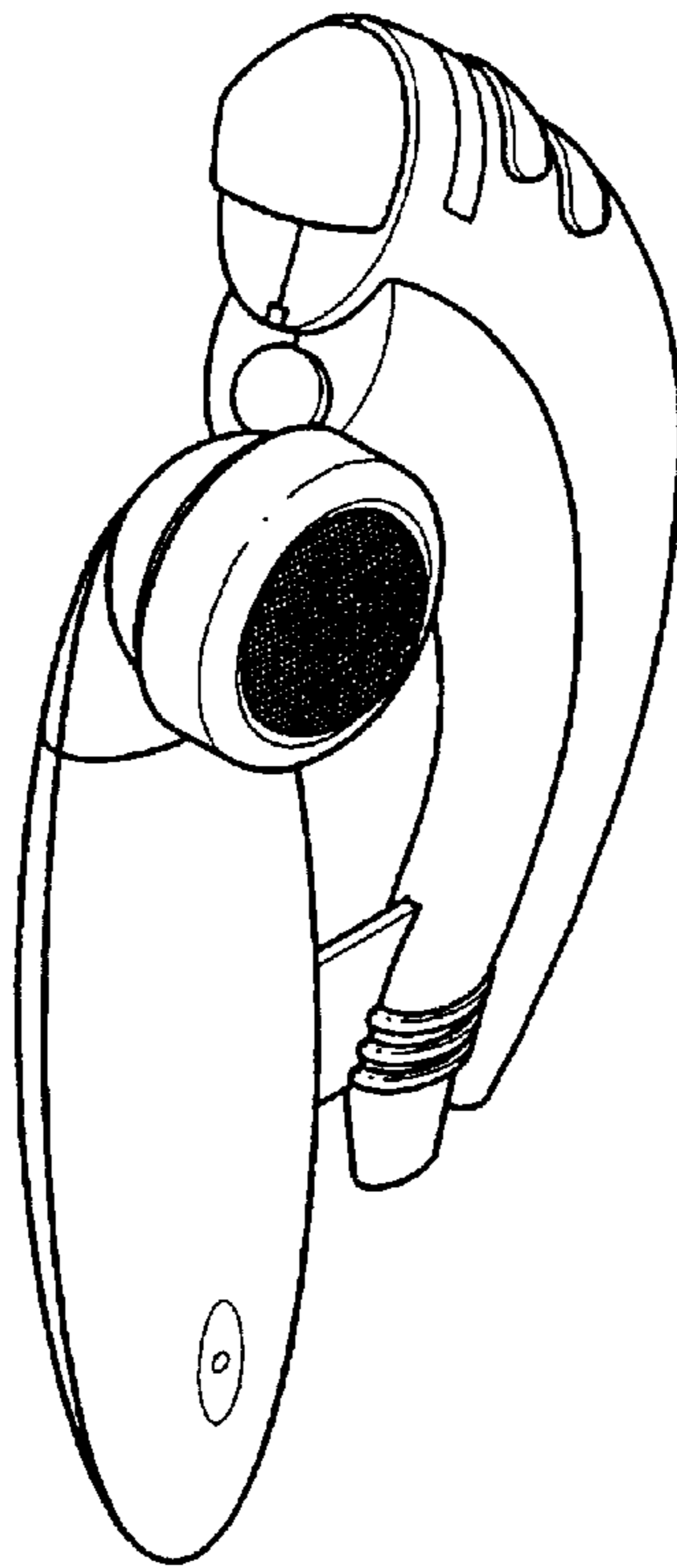

FIG. 5

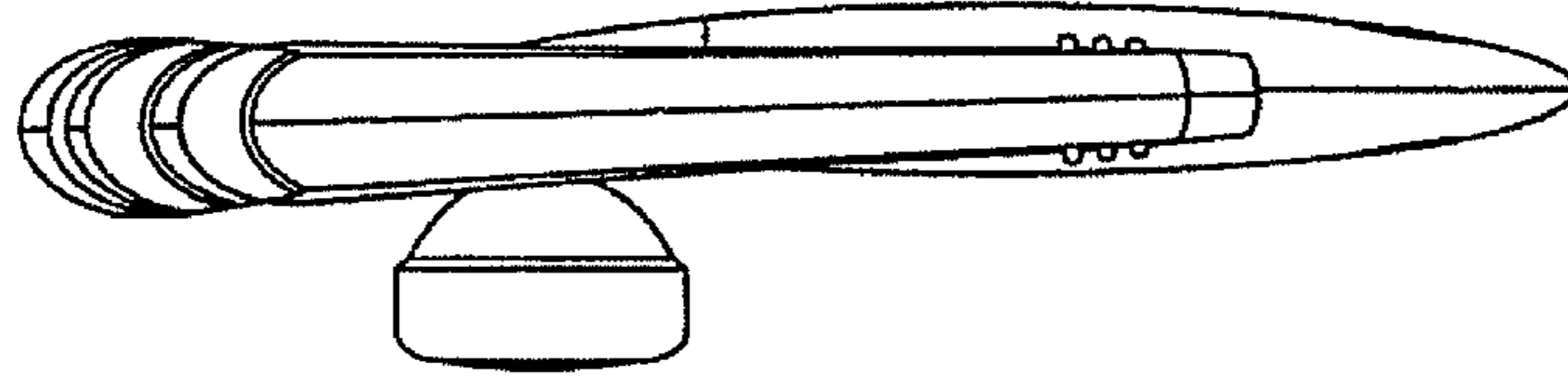

FIG. 4

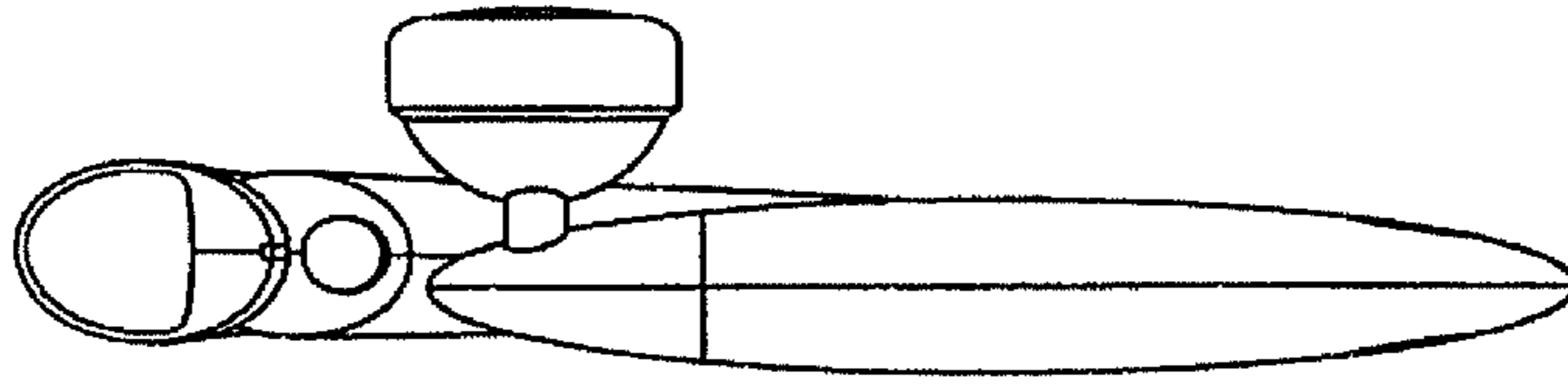

FIG. 3

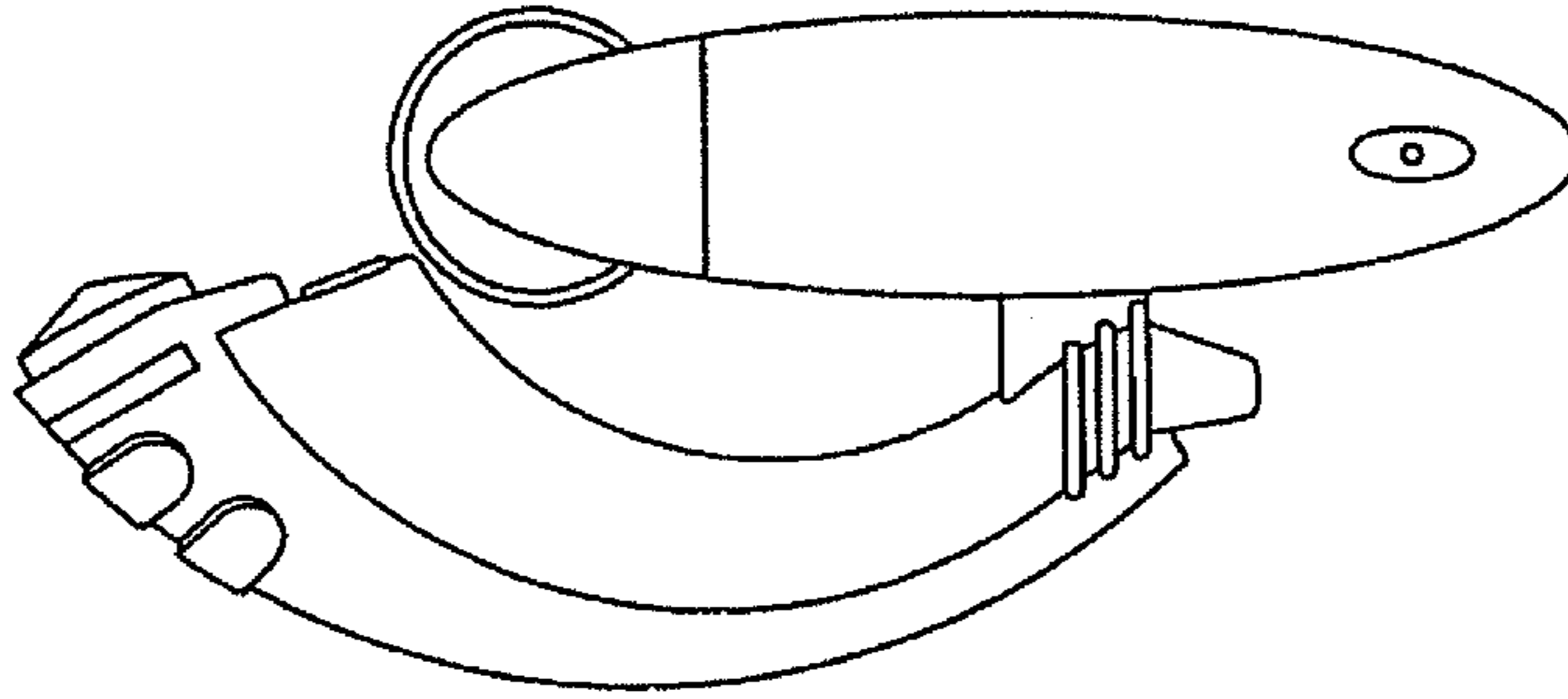

FIG. 2

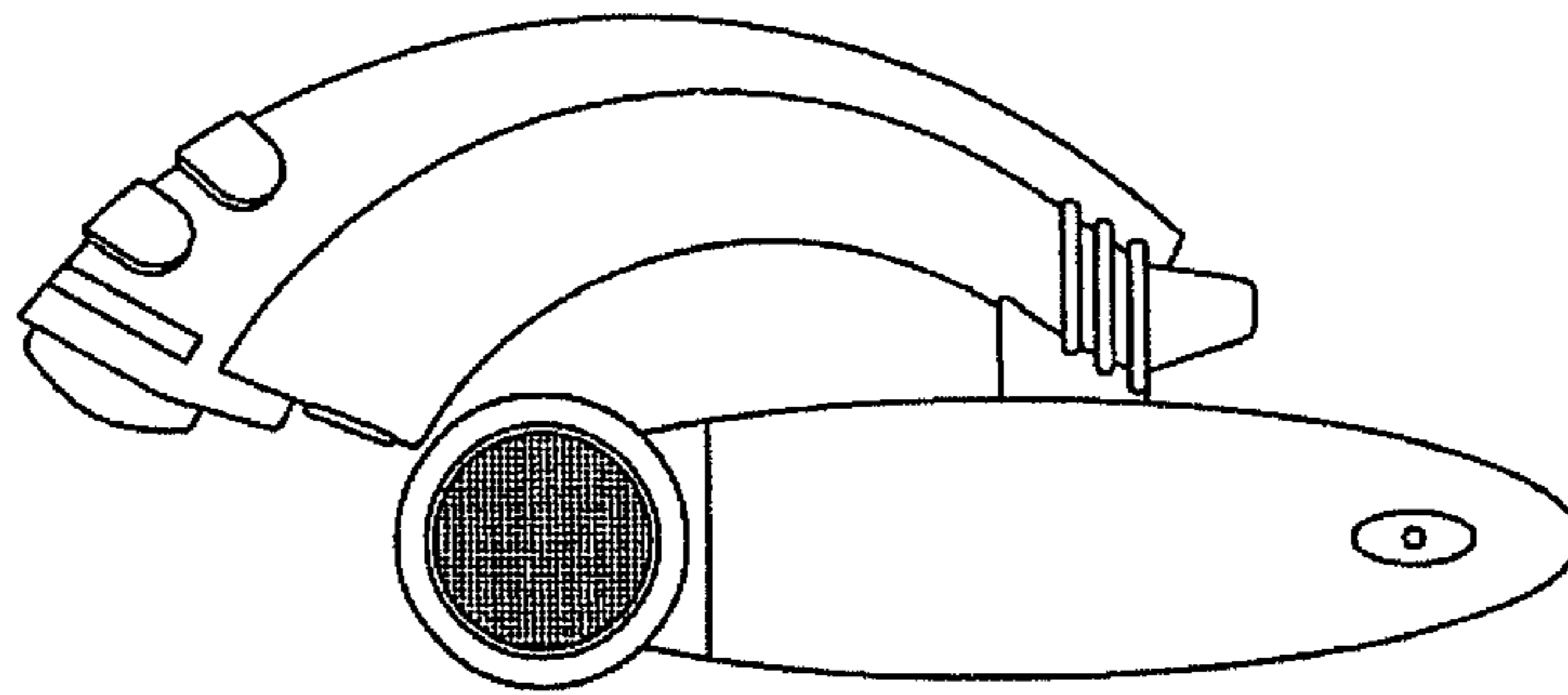

FIG. 6

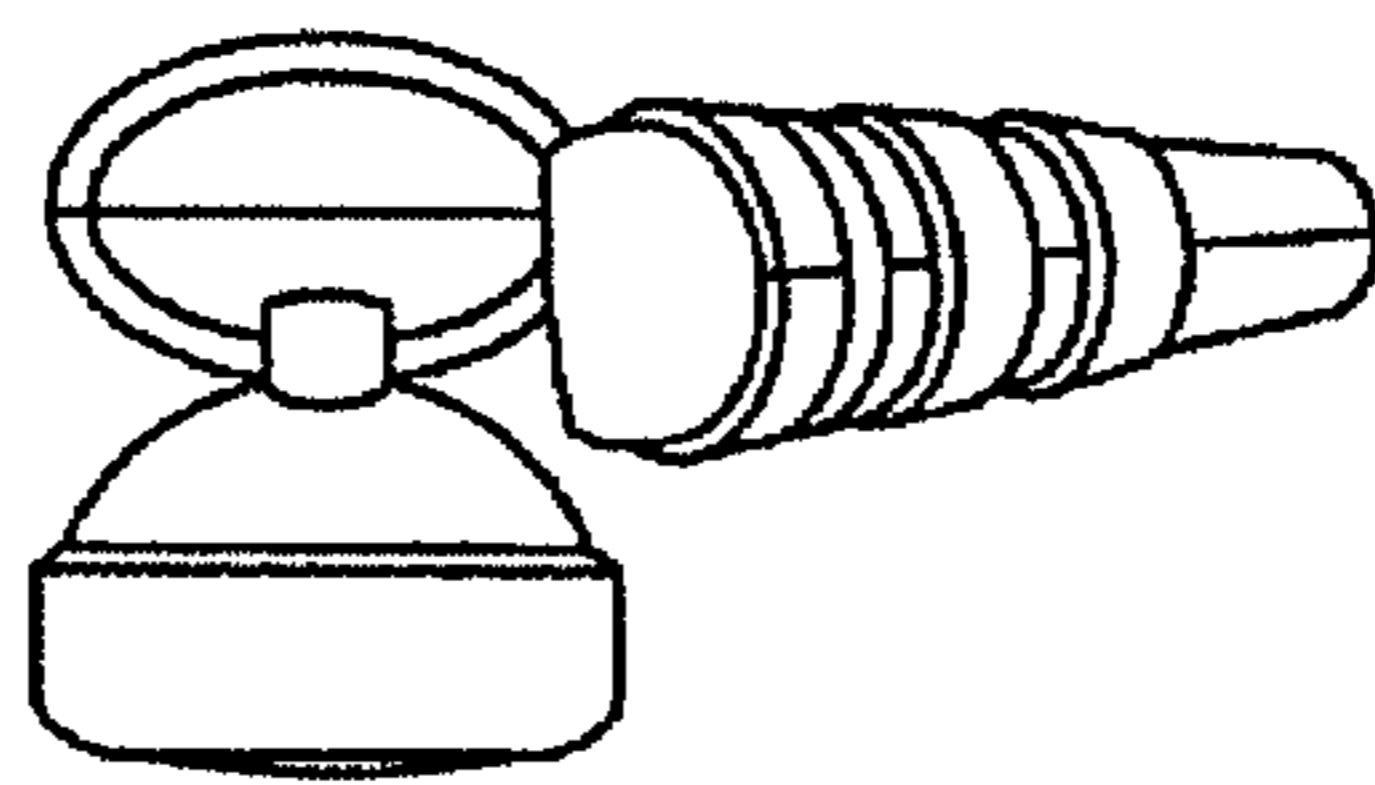

FIG. 7

