



US00D537062S

(12) **United States Design Patent** (10) **Patent No.:** **US D537,062 S**  
**Kim et al.** (45) **Date of Patent:** **\*\* Feb. 20, 2007**

(54) **PORTABLE PHONE**

(75) Inventors: **Eun-Young Kim**, Seoul (KR);  
**Jong-Seong Lee**, Seoul (KR); **Yang-Jic Lee**, Seoul (KR)

(73) Assignee: **Samsung Electronics Co., Ltd.**,  
Suwon-Si (KR)

(\*\*) **Term:** **14 Years**

(21) Appl. No.: **29/236,926**

(22) Filed: **Aug. 25, 2005**

(30) **Foreign Application Priority Data**

Feb. 25, 2005 (KR) ..... 30-2005-0006300

(51) **LOC (8) Cl.** ..... **14-03**

(52) **U.S. Cl.** ..... **D14/138**

(58) **Field of Classification Search** ..... D14/137,  
D14/138, 147-148, 247-248, 144, 496, 156,  
D14/341-347, 191, 192; 379/433.01-433.13;  
455/575.4, 566, 575.1, 556.1, 556.2, 90.3,  
455/41.2; D21/329, 331, 333; D16/208

See application file for complete search history.

(56) **References Cited**

**U.S. PATENT DOCUMENTS**

D326,452 S	*	5/1992	Roegner	.....	D14/138
D357,919 S	*	5/1995	Tsui	.....	D14/218
D445,409 S	*	7/2001	Segers	.....	D14/138
D456,805 S	*	5/2002	Ono et al.	.....	D14/342
D457,883 S	*	5/2002	Sugioka et al.	.....	D14/342
D460,448 S	*	7/2002	Matsumoto	.....	D14/346
D464,963 S	*	10/2002	Nishida	.....	D14/346
D465,219 S	*	11/2002	Tamaki et al.	.....	D14/346
D477,596 S	*	7/2003	Hayes	.....	D14/343
D479,234 S	*	9/2003	Tanaka et al.	.....	D14/346
D495,695 S	*	9/2004	Yugaya	.....	D14/346
D498,736 S	*	11/2004	Lee	.....	D14/138
D501,475 S	*	2/2005	Kim	.....	D14/346
D502,703 S	*	3/2005	Tsujimoto et al.	.....	D14/346

D511,342 S	*	11/2005	Chien	.....	D14/346
D515,060 S	*	2/2006	Lee et al.	.....	D14/138
D517,042 S	*	3/2006	Byun et al.	.....	D14/191
D519,998 S	*	5/2006	Park	.....	D14/346

(Continued)

**OTHER PUBLICATIONS**

Pantech PG-3600V telephone, announced Feb. 2006, [online], [retrieved on May 30, 2006]. Retrieved from Internet, URL: <http://www.gsmarena.com>.\*

O2 XDA Atom telephone, announced Nov. 2005, [online], [retrieved on May 5, 2006]. Retrieved from Internet, URL: <http://www.gsmerena.com>.\*

Sharp TM100 telephone, announced First Quarter 2004, [online], [retrieved on Apr. 28, 2006]. Retrieved from Internet, URL: <http://www.gsmarena.com>.\*

Virgin Player, review date Nov. 22, 2004, [online], [retrieved on Aug. 1, 2006]. Retrieved from Internet, URL: <http://www.pcmag.com>.\*

*Primary Examiner*—Jeffrey Asch

(74) *Attorney, Agent, or Firm*—Staas & Halsey LLP

(57) **CLAIM**

The ornamental design for the portable phone, as shown and described.

**DESCRIPTION**

FIG. 1 is a perspective view of the portable phone showing our design;

FIG. 2 is a front view thereof;

FIG. 3 is a rear view thereof;

FIG. 4 is a left side view thereof;

FIG. 5 is a right side view thereof;

FIG. 6 is a top plan view thereof;

FIG. 7 is a bottom plan view thereof;

FIG. 8 is a front, partially open view thereof; and,

FIG. 9 is a rear view thereof with accessory removed and shown adjacent thereto.

**1 Claim, 6 Drawing Sheets**

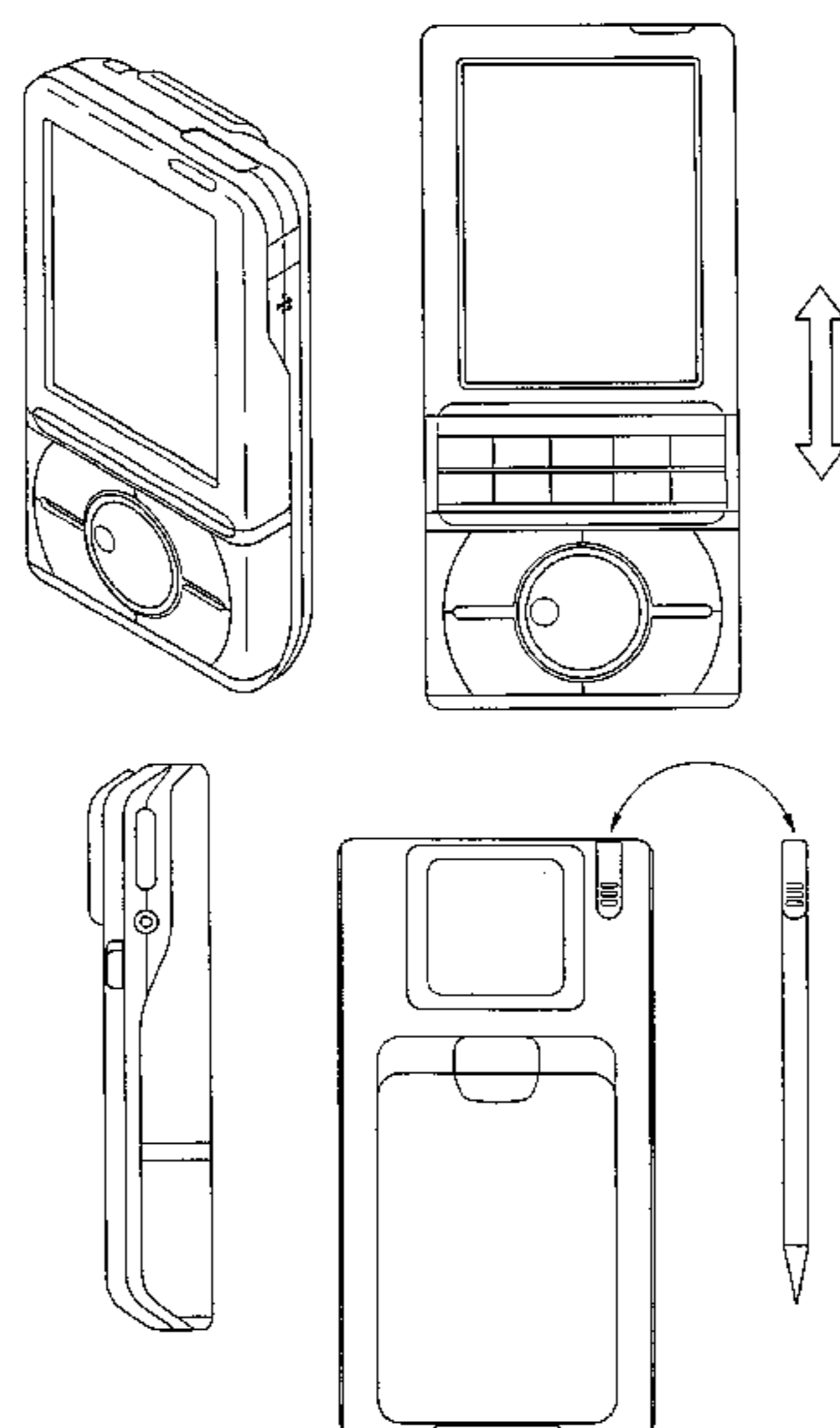

# US D537,062 S

Page 2

---

## U.S. PATENT DOCUMENTS

D525,959	S	*	8/2006	Kim et al.	.....	D14/138			
2002/0102946	A1	*	8/2002	SanGiovanni	.....	455/90			
2003/0064688	A1	*	4/2003	Mizuta et al.	.....	455/90			
2005/0070348	A1	*	3/2005	Lee et al.	.....	455/575.4			
2005/0124398	A1	*	6/2005	Lee et al.	.....	455/575.4			
2005/0190291	A1	*	9/2005	Kota et al.	.....	348/376			
2005/0245297	A1	*	11/2005	Lee et al.	.....	455/575.4			
2005/0255897	A1	*	11/2005	Lee et al.	.....	455/575.4			
2005/0266897	A1	*	12/2005	Ahn et al.	.....	455/575.1			
2006/0025184	A1	*	2/2006	Cho et al.	.....	455/575.4			
2006/0094464	A1	*	5/2006	Kyou et al.	.....	455/556.1			
2006/0142073	A1	*	6/2006	Gordecki	.....	455/575.4			
2006/0154705	A1	*	7/2006	Kim	.....	455/575.4			

\* cited by examiner

FIG. 1

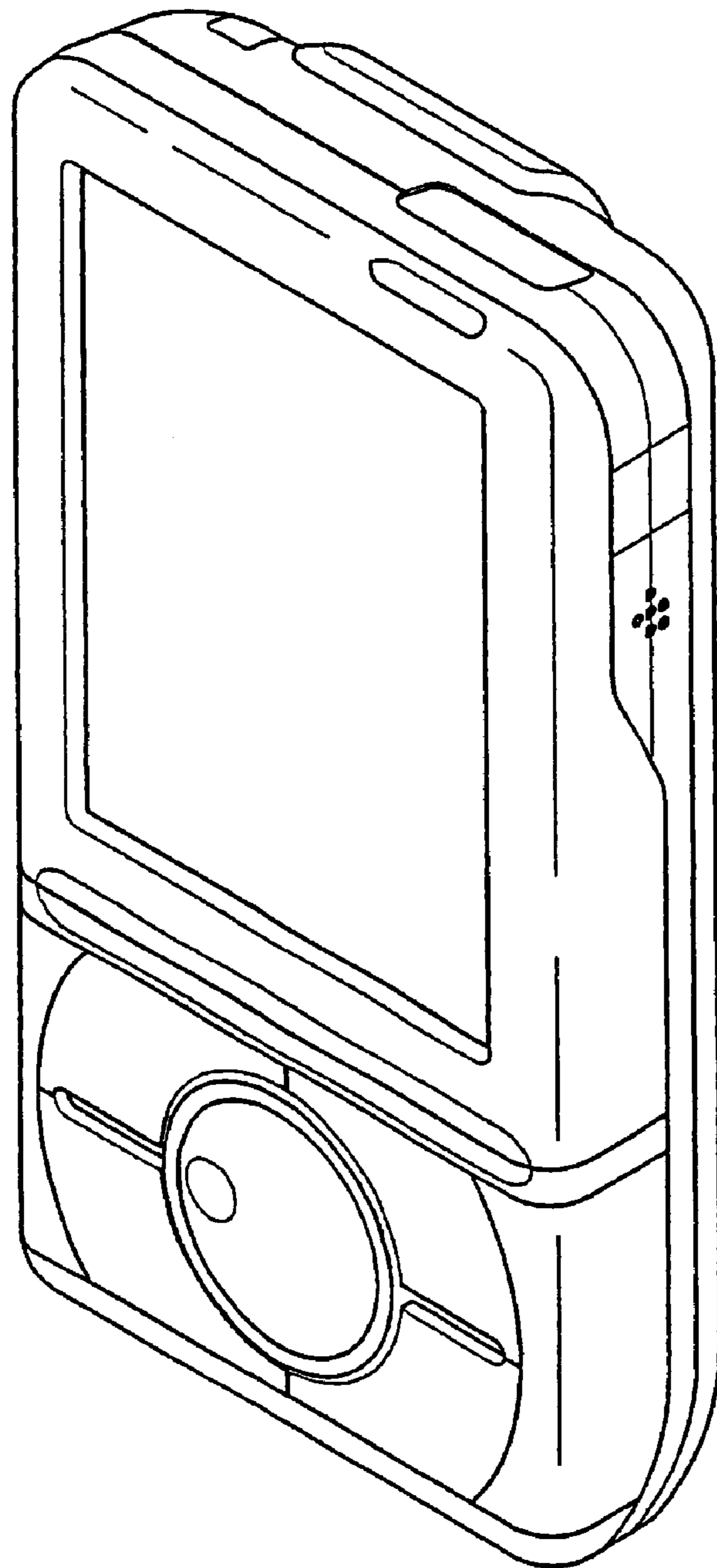

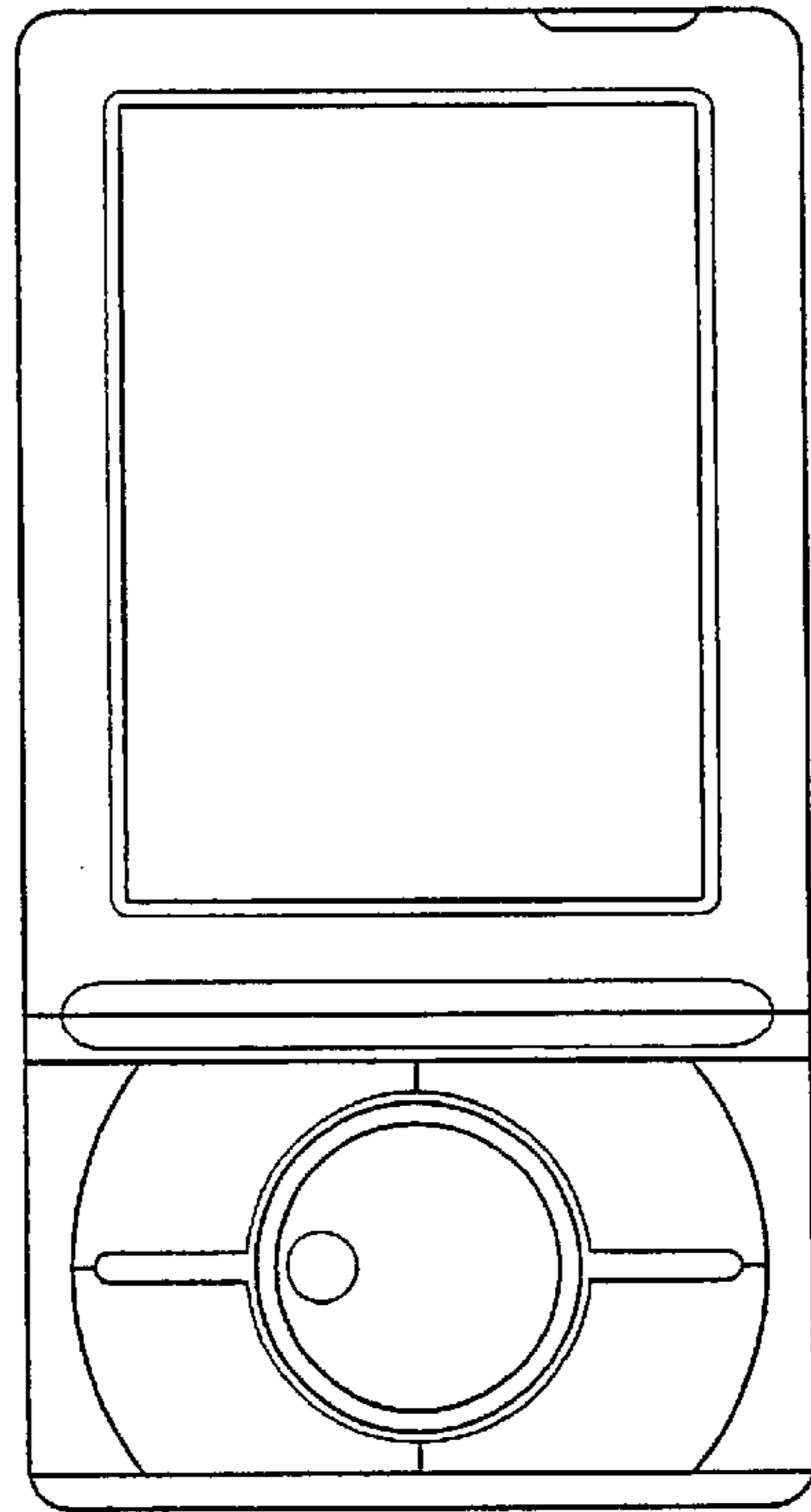

FIG. 2

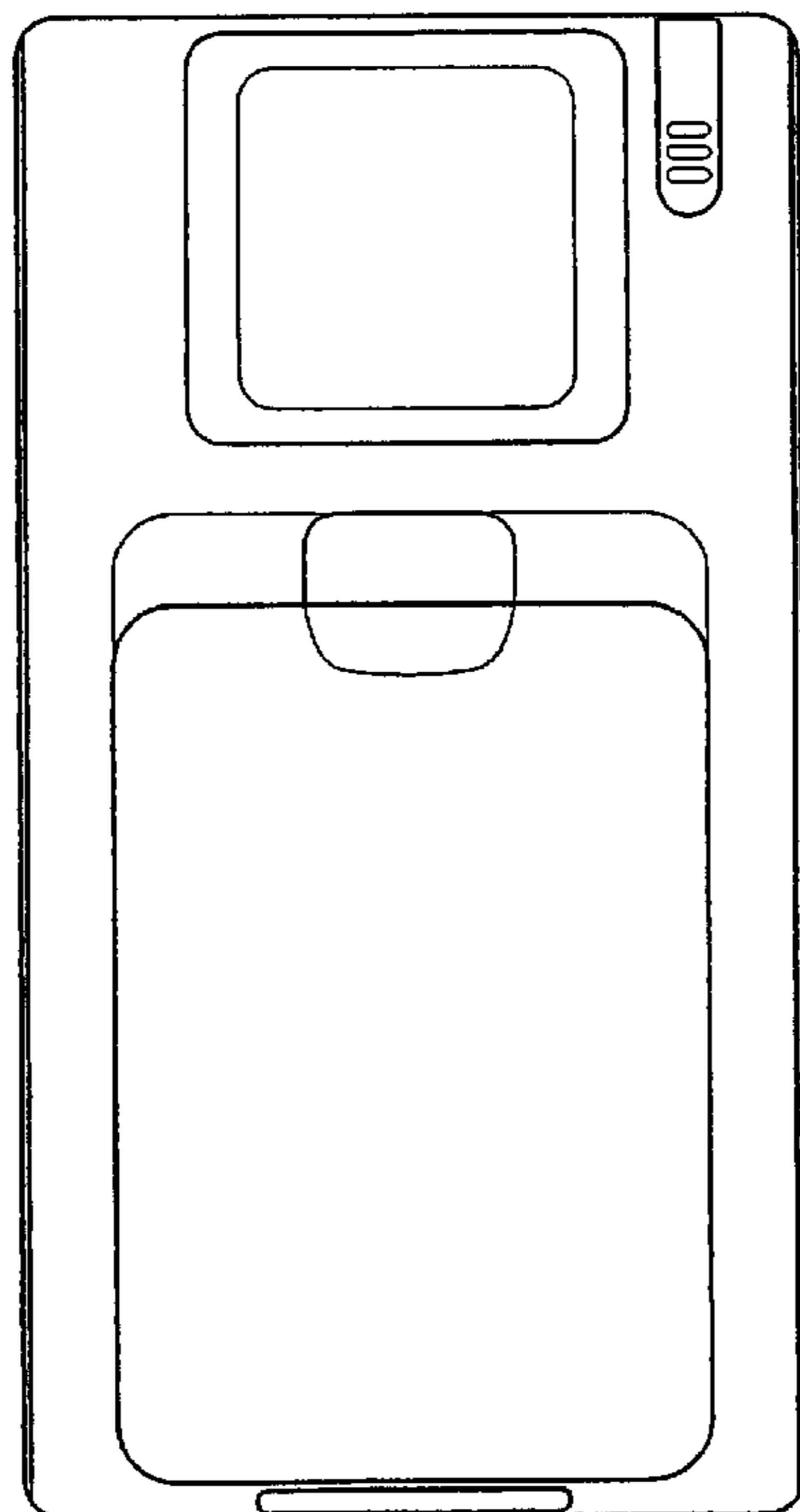

FIG. 3

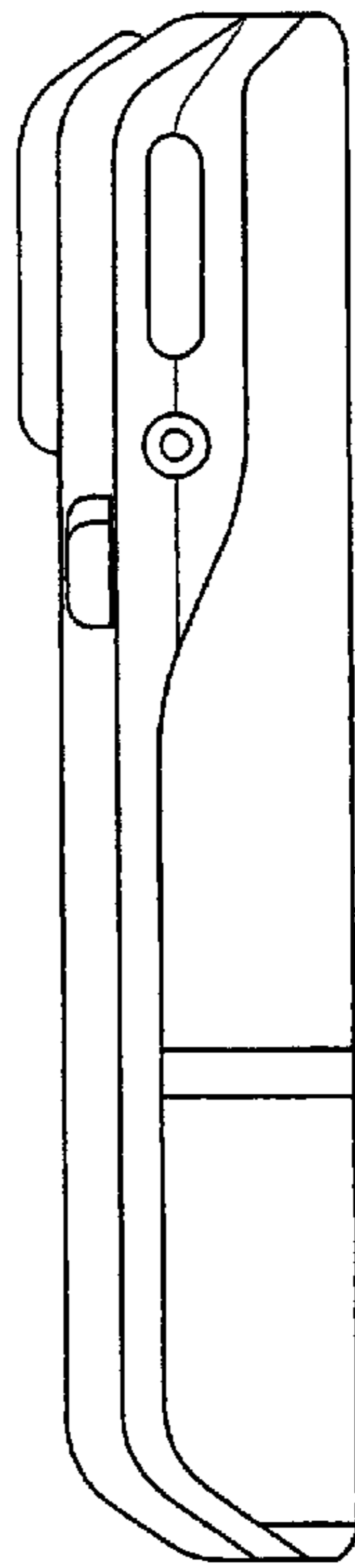

FIG. 4

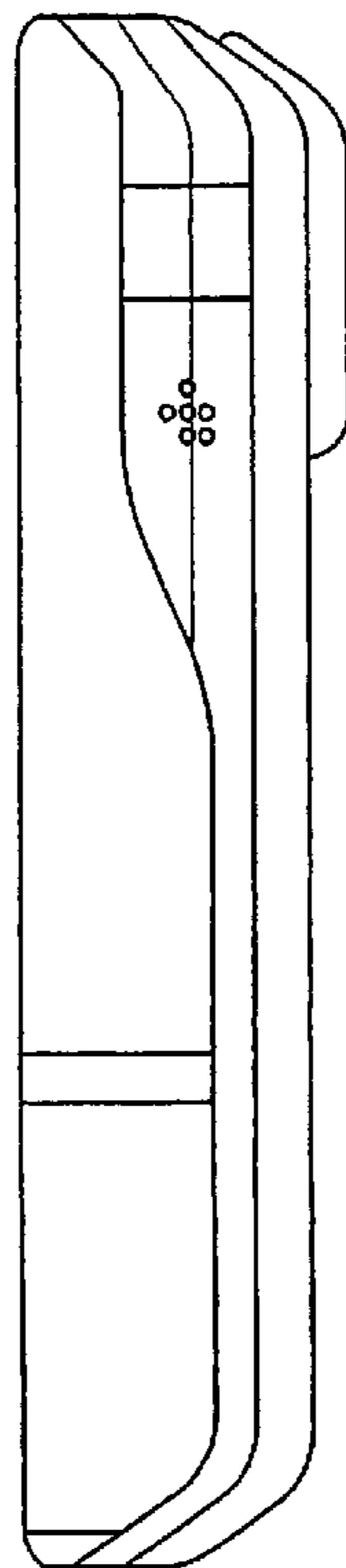

FIG. 5

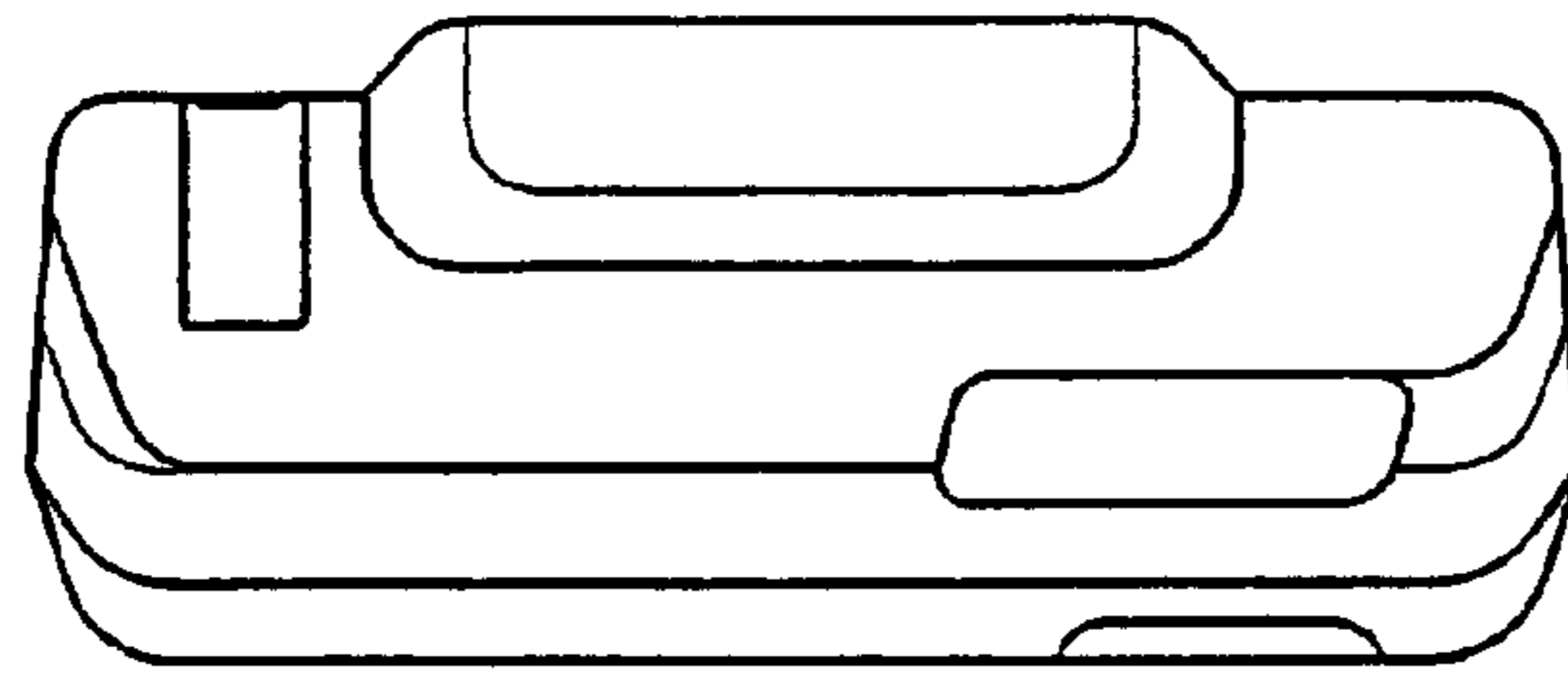

FIG. 6

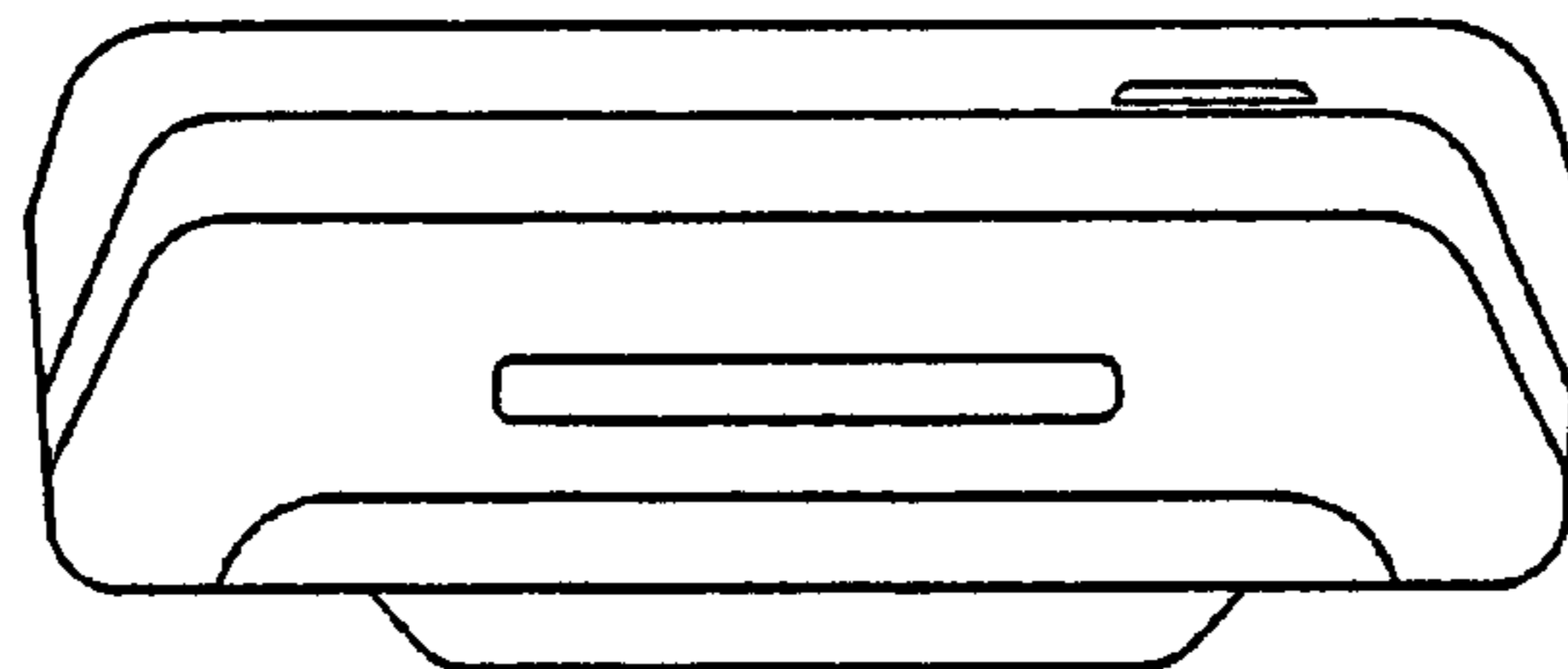

FIG. 7

FIG. 8

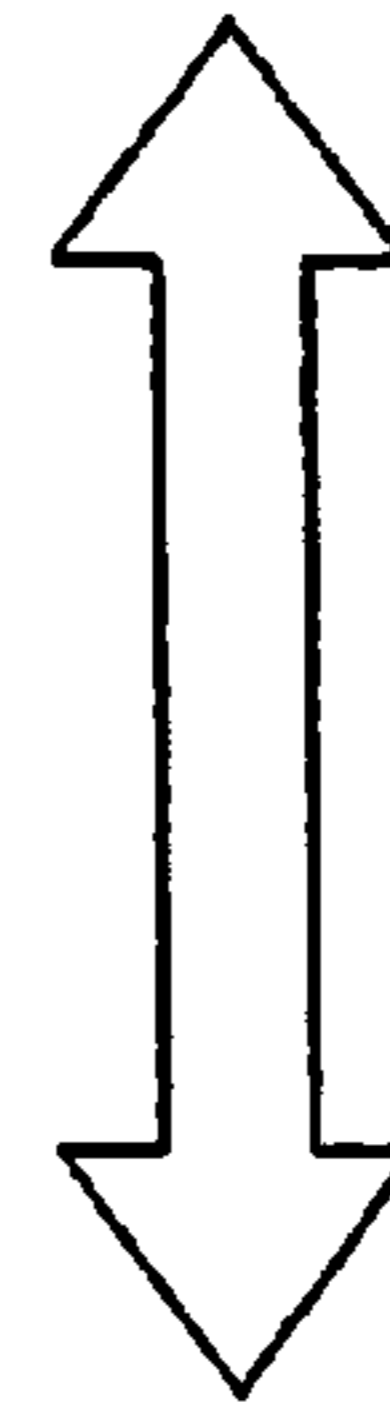
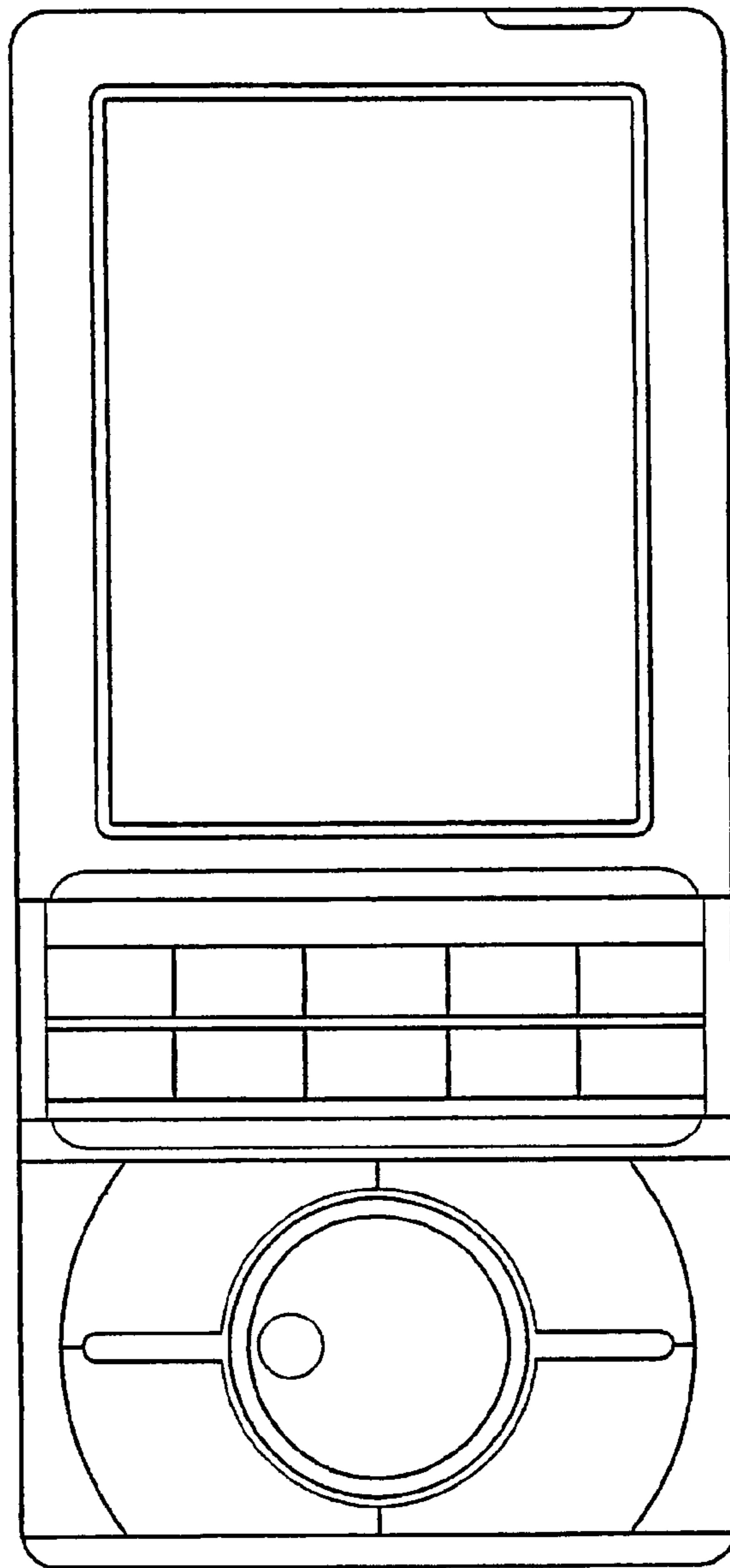

FIG. 9

