



US00D537048S

(12) **United States Design Patent**
Mitsui

(10) **Patent No.:** **US D537,048 S**

(45) **Date of Patent:** **** Feb. 20, 2007**

(54) **PHOTOMASK BLANK**
(75) Inventor: **Masaru Mitsui**, Mukawa-mura (JP)
(73) Assignee: **Hoya Corporation**, Tokyo (JP)
(**) Term: **14 Years**

(21) Appl. No.: **29/213,840**
(22) Filed: **Sep. 23, 2004**

(30) **Foreign Application Priority Data**

May 17, 2004 (JP) 2004-014506

(51) **LOC (8) Cl.** **13-03**
(52) **U.S. Cl.** **D13/182**
(58) **Field of Classification Search** D13/182;
D8/349, 354, 382; D6/300; D19/26, 32, 34;
206/453; 281/20, 42, 45; 428/430, 848.5;
430/5; 382/144, 145, 147, 181
See application file for complete search history.

(56) **References Cited**

U.S. PATENT DOCUMENTS

1,676,741 A * 7/1928 Moskowitz 281/20
2,728,451 A * 12/1955 Leander 206/453
5,112,727 A * 5/1992 Inui et al. 430/321
5,217,256 A * 6/1993 Lomas 281/20
5,234,781 A * 8/1993 Sakamoto et al. 430/5
6,122,035 A * 9/2000 Rolson 355/53
D441,730 S * 5/2001 Oba D13/182
6,285,783 B1 * 9/2001 Isomura et al. 382/147
D502,866 S * 3/2005 Woollard D8/382
2002/0187407 A1 * 12/2002 Priestley et al. 430/5
2003/0118918 A1 * 6/2003 Ohta 430/5
2003/0198873 A1 * 10/2003 Kokjohn 430/5

2004/0265708 A1 * 12/2004 Misaka 430/5
2005/0120326 A1 * 6/2005 Semmler et al. 716/19
2005/0147893 A1 * 7/2005 Ogawa et al. 430/5
2005/0269814 A1 * 12/2005 Dillavou et al. 281/20

OTHER PUBLICATIONS

U.S. Appl. No. 29/213,841, filed Sep. 23, 2004, Inventors:
Masaru Mitsui, et al., Entitled: Photomask Blank.

* cited by examiner

Primary Examiner—Selina Sikder

(74) *Attorney, Agent, or Firm*—Frishauf, Holtz, Goodman
& Chick, P.C.

(57) **CLAIM**

The ornamental design for a photomask blank, as shown and
described.

DESCRIPTION

FIG. 1 is a front elevational view of a photomask blank
showing my new design;
FIG. 2 is a rear elevational view thereof;
FIG. 3 is a left side view thereof;
FIG. 4 is a right side view thereof;
FIG. 5 is a top plan view thereof;
FIG. 6 is a bottom plan view thereof;
FIG. 7 is an enlarged partial front view along line 7—7 in
FIG. 1;
FIG. 8 is a reduced scale front, left side, top perspective view
of the portion shown in FIG. 7; and,
FIG. 9 is a sectional view along line 9—9 in FIG. 7.
The broken line showing is for illustrative purposes only and
forms no part of the claimed design.

1 Claim, 6 Drawing Sheets

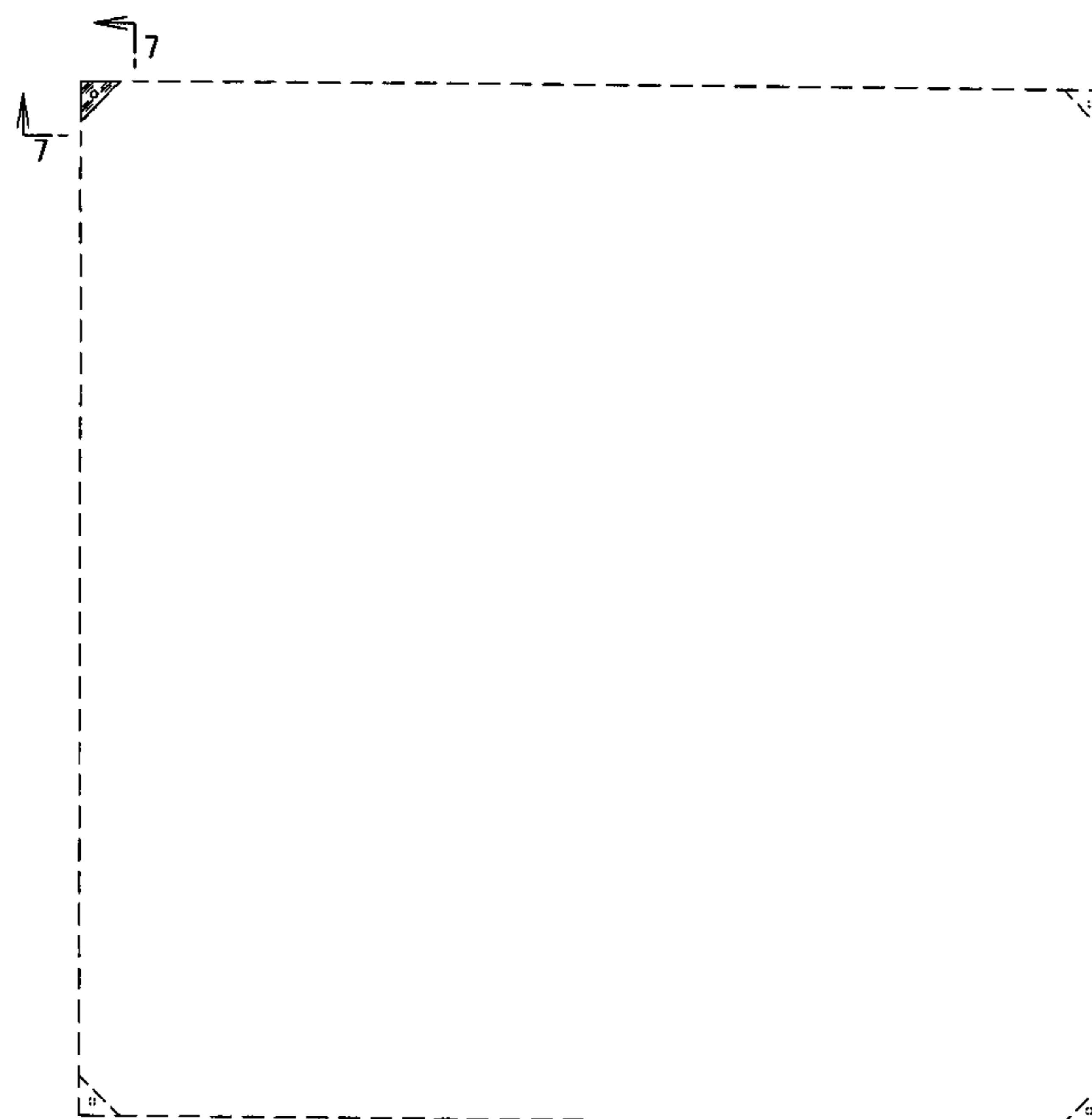

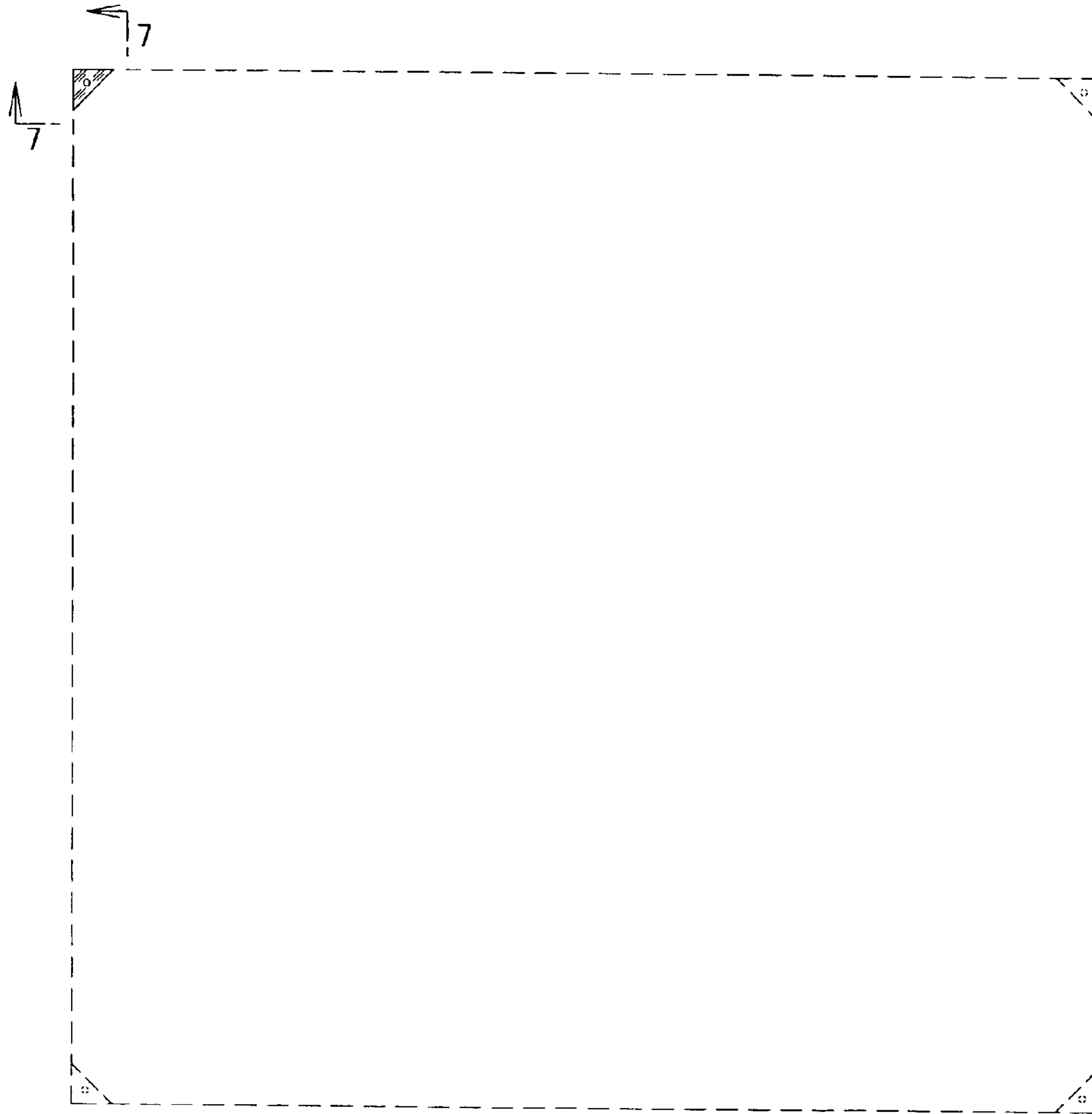

FIG. 1



FIG. 2



FIG. 3



FIG. 4

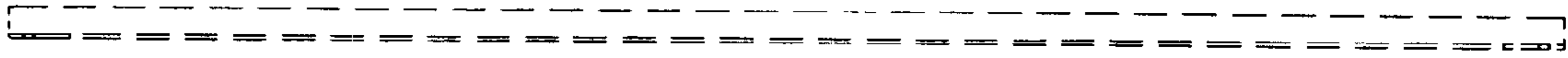

FIG. 5

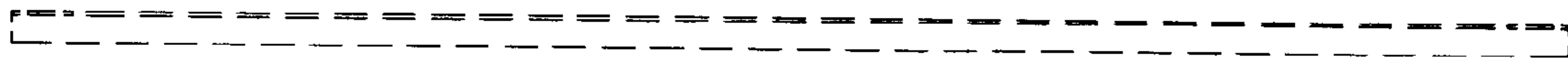

FIG. 6

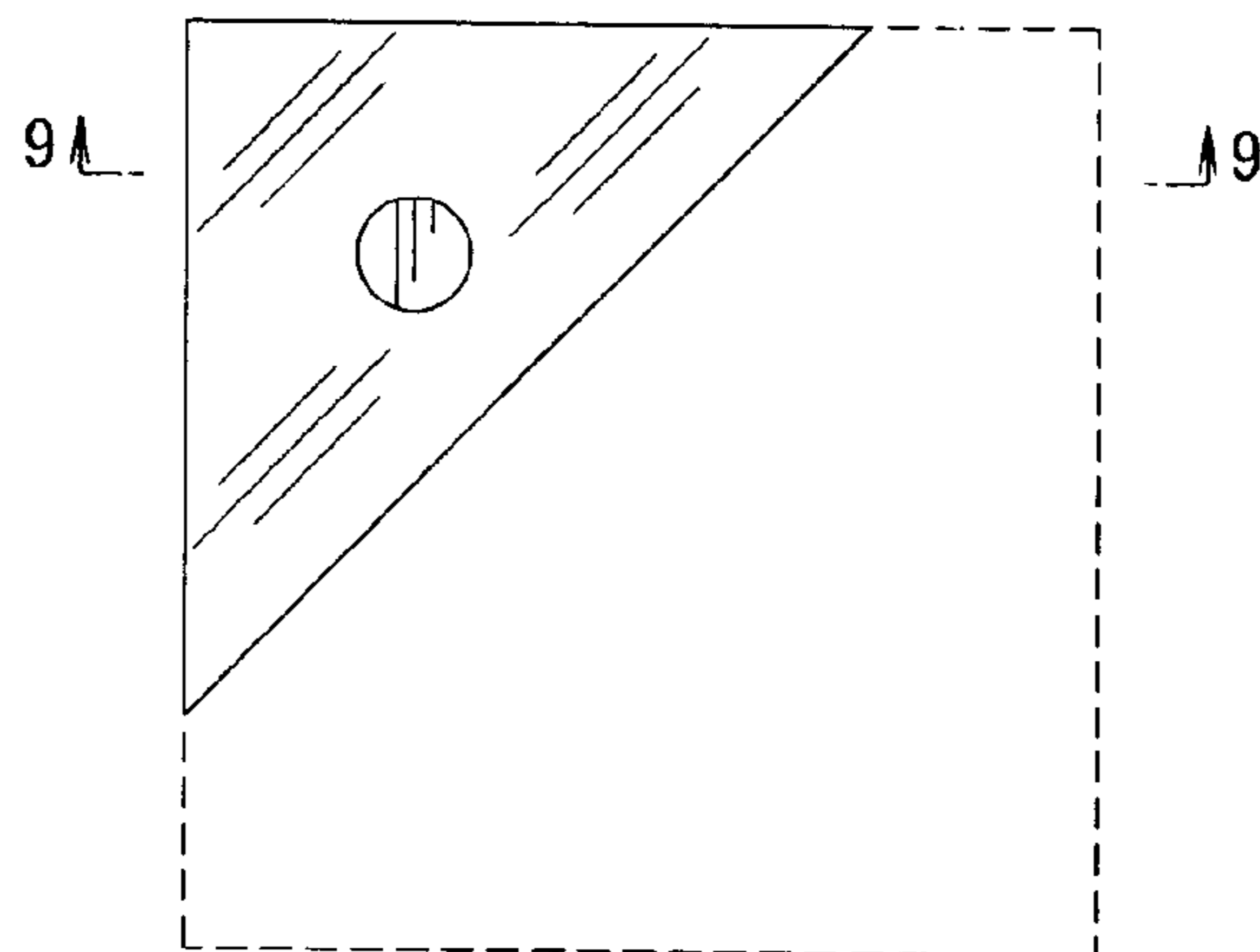

FIG. 7

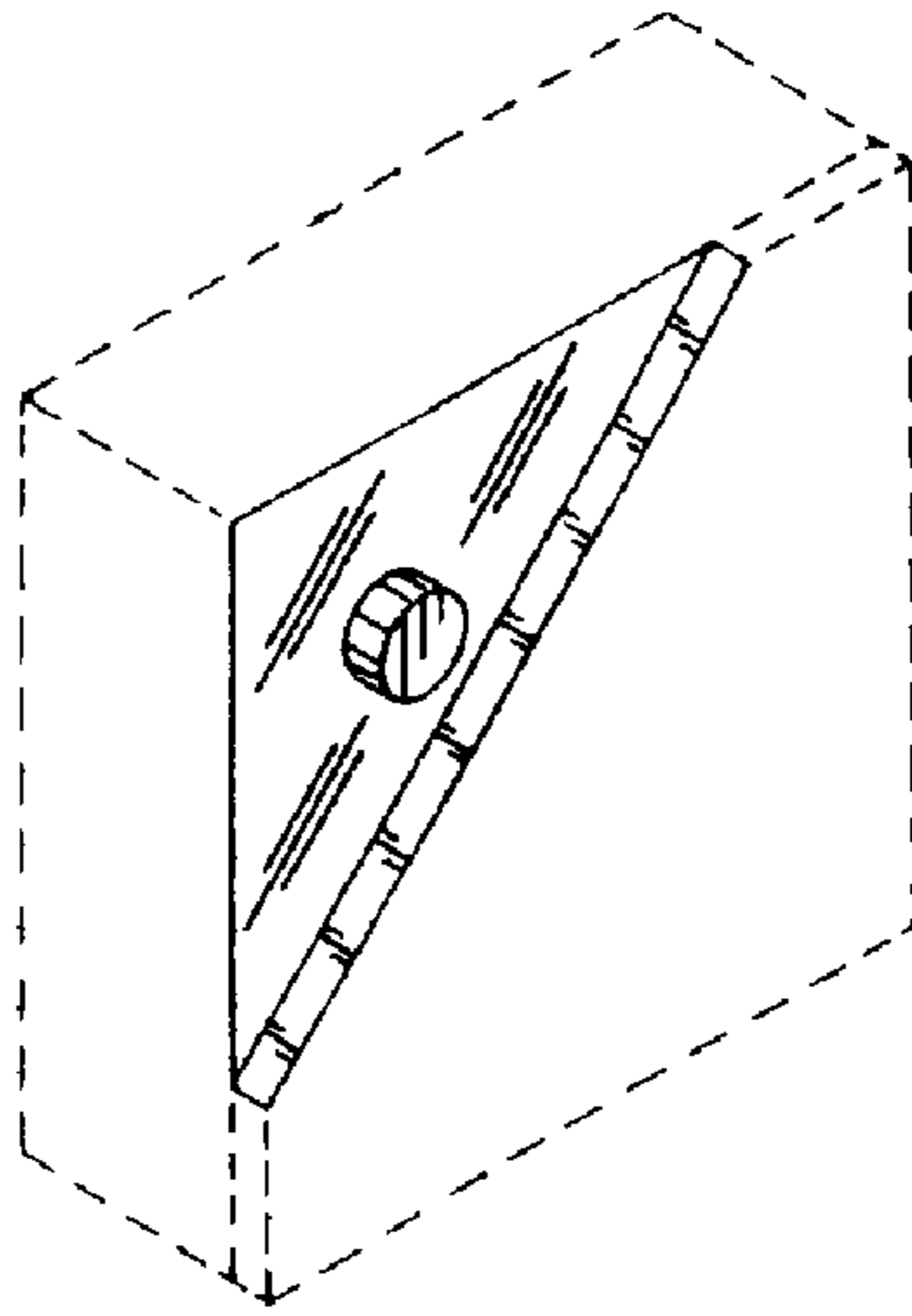

FIG. 8

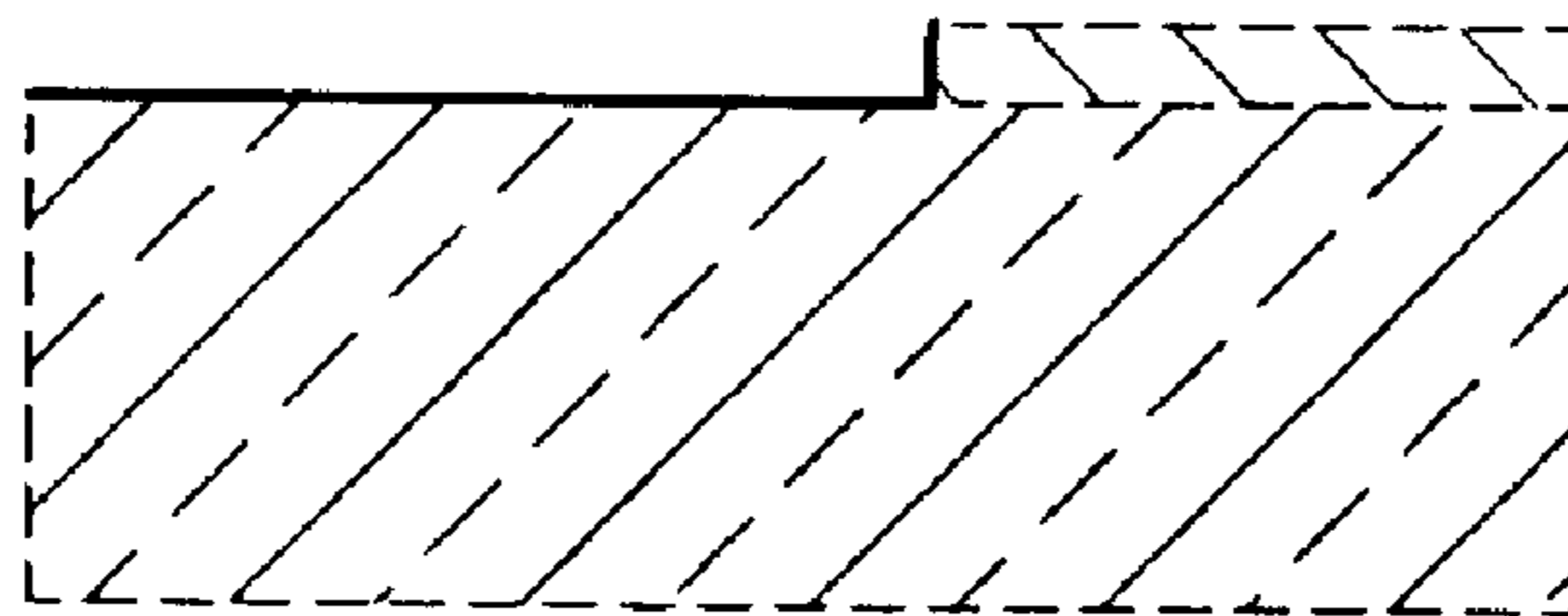

FIG. 9