



US00D536986S

(12) **United States Design Patent** (10) **Patent No.:** **US D536,986 S**
Nix et al. (45) **Date of Patent:** **** Feb. 20, 2007**

(54) **COMBINED BOTTLE AND CAP**

(57) **CLAIM**

(75) Inventors: **Ronald Dale Nix**, Seattle, WA (US); **Sam Ciulla**, Wilmette, IL (US); **Lori Cerwin**, Gurnee, IL (US); **Scott Hardy**, Evanston, IL (US); **Peter Chun**, Evanston, IL (US); **Vincent H. Bowman**, Highland Park, IL (US); **George Nukuto**, Des Plaines, IL (US)

The ornamental designs for a combined bottle and cap, as shown and described.

DESCRIPTION

(73) Assignees: **Jim Beam Brands Company**, Deerfield, IL (US); **Starbucks Corporation**, Seattle, WA (US)

FIG. 1 is a front elevational view of the bottle portion shown in FIG. 8 with the cap removed;
FIG. 2 is a bottom, rear perspective view thereof;
FIG. 3 is a rear elevational view thereof;
FIG. 4 is a left side elevational view thereof;
FIG. 5 is a right side elevational view thereof;
FIG. 6 is a bottom plan view thereof;
FIG. 7 is a top plan view thereof;
FIG. 8 is a top, front elevational view of a combined bottle and cap showing our new design;
FIG. 9 is a bottom, rear perspective view thereof;
FIG. 10 is a rear elevational view thereof;
FIG. 11 is a left side elevational view thereof;
FIG. 12 is a right side elevational view thereof;
FIG. 13 is a bottom plan view thereof;
FIG. 14 is a top plan view thereof;
FIG. 15 is a front elevational view of a second embodiment of a combined bottle and cap showing our new design;
FIG. 16 is a bottom, rear perspective view thereof;
FIG. 17 is a rear elevational view thereof;
FIG. 18 is a left side elevational view thereof;
FIG. 19 is a right side elevational view thereof;
FIG. 20 is a bottom plan view thereof;
FIG. 21 is a top plan view thereof;
FIG. 22 is a front elevational view of the cap portion of the bottle shown in FIG. 8 with the bottle portion removed;
FIG. 23 is a rear elevational view thereof;
FIG. 24 is a left side elevational view thereof;
FIG. 25 is a right side elevational view thereof;
FIG. 26 is a top plan view thereof; and,
FIG. 27 is a bottom plan view thereof.
The broken lines shown in the drawings are for illustrative purposes only and form no part of the claimed design.

(**) Term: **14 Years**

(21) Appl. No.: **29/210,383**

(22) Filed: **Jul. 30, 2004**

(51) **LOC (8) Cl.** **09-01**

(52) **U.S. Cl.** **D9/551; D9/669**

(58) **Field of Classification Search** D9/454,
D9/451, 500, 503, 516, 549, 551, 558, 669,
D9/716; 215/370, 371, 379, 381-384; 220/660;
D7/300.1, 510-511

See application file for complete search history.

(56) **References Cited**

U.S. PATENT DOCUMENTS

213,606 A 3/1879 Atwater

(Continued)

FOREIGN PATENT DOCUMENTS

RU 49650 12/2001

Primary Examiner—Ian Simmons

Assistant Examiner—Dana Sipos

(74) *Attorney, Agent, or Firm*—Leydig, Voit & Mayer, Ltd.

1 Claim, 20 Drawing Sheets

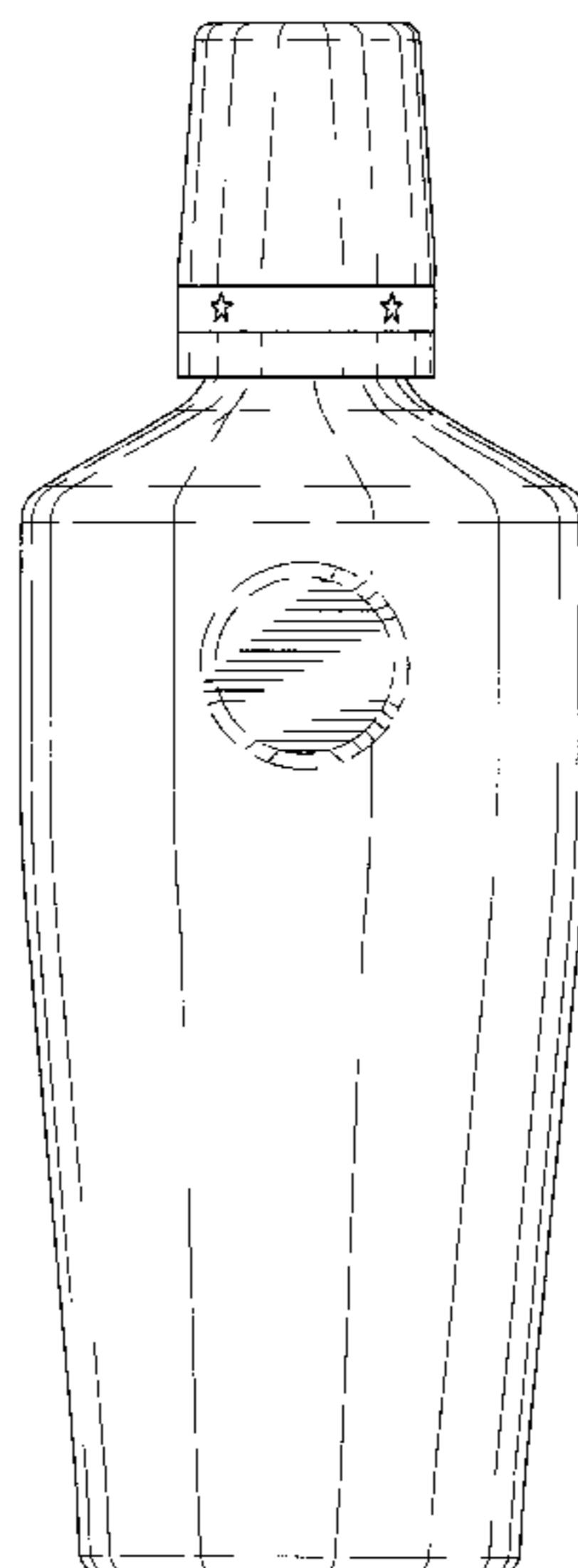

US D536,986 S

Page 2

U.S. PATENT DOCUMENTS

D18,021 S	1/1888	Atwater		D353,324 S	* 12/1994	Rice, III	D9/661
D18,220 S	4/1888	Atterbury		D355,601 S	2/1995	Buettner et al.		
D20,527 S	2/1891	Nicholson		D366,214 S	1/1996	Cooper		
D21,495 S	4/1892	Richter		D366,618 S	1/1996	Brillet et al.		
739,616 A	* 9/1903	Oxley 215/379	D400,797 S	11/1998	de Mourgues		
D56,029 S	8/1920	Quigg		D402,893 S	* 12/1998	Monaghan	D9/500
D77,052 S	12/1928	Bramble		D414,427 S	9/1999	Maddy		
1,765,129 A	* 6/1930	Cooke 220/568	D433,339 S	11/2000	Colonna de Giovellina		
D93,704 S	* 10/1934	Conner D9/454	D452,442 S	* 12/2001	Bowen	D9/503
D96,966 S	* 9/1935	Fuerst D7/397	D466,371 S	* 12/2002	Parker	D7/510
D120,769 S	5/1940	Wilmet		D467,181 S	12/2002	Versace		
D184,611 S	3/1959	Du Pree		D470,057 S	* 2/2003	Bowen	D9/551
D195,532 S	* 6/1963	Otto D9/529	D473,460 S	4/2003	Whitworth		
D198,054 S	4/1964	Lowry		D476,193 S	* 6/2003	Janky	D7/510
D242,125 S	11/1976	de Torres		D483,982 S	* 12/2003	Irvine	D7/300.1
4,003,555 A	* 1/1977	Swartz 366/130	D488,673 S	* 4/2004	Farce	D7/523
D250,248 S	* 11/1978	Grip D9/726	D489,627 S	5/2004	Klitsner et al.		
D323,113 S	1/1992	Middleton		D495,186 S	* 8/2004	Poupel et al.	D7/300.1
D336,035 S	* 6/1993	Baker D9/669	D509,707 S	* 9/2005	Tien	D7/510
D345,921 S	* 4/1994	Frank et al. D9/574	D522,366 S	* 6/2006	Scott	D9/500

* cited by examiner

FIG. 1

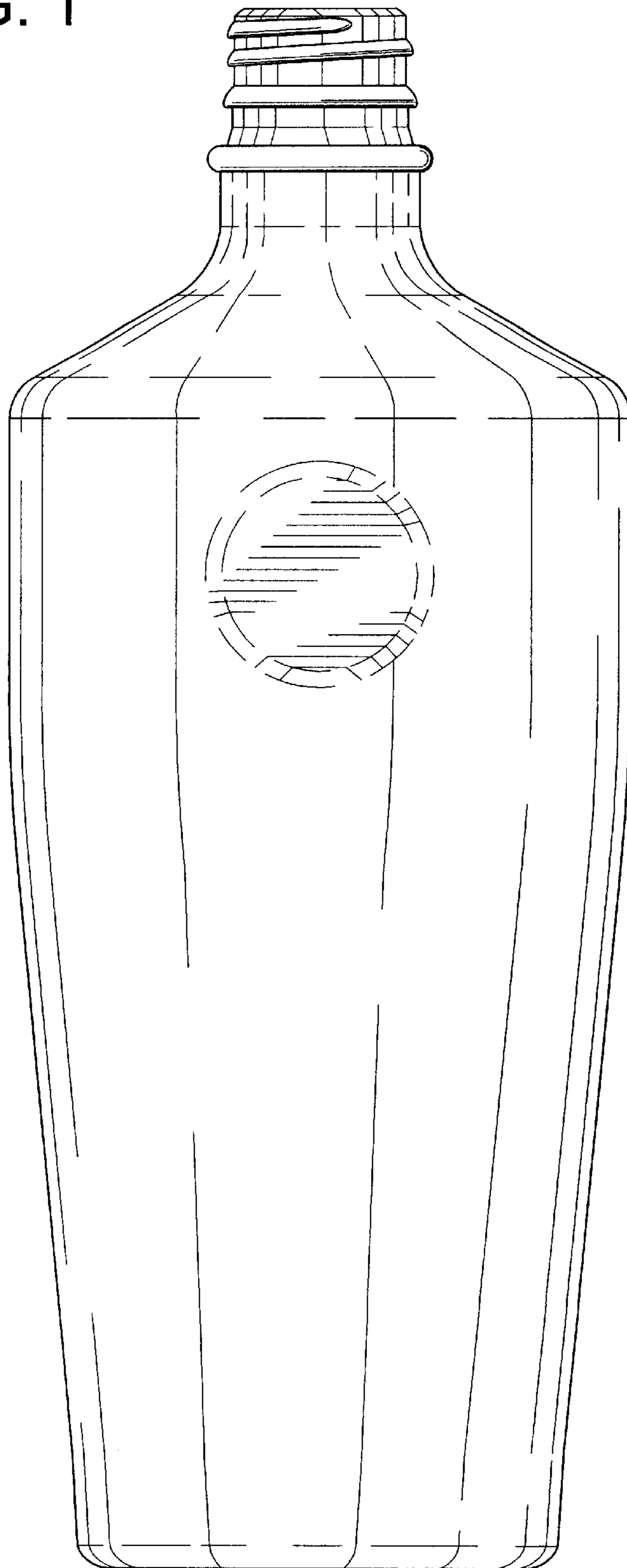

FIG. 2

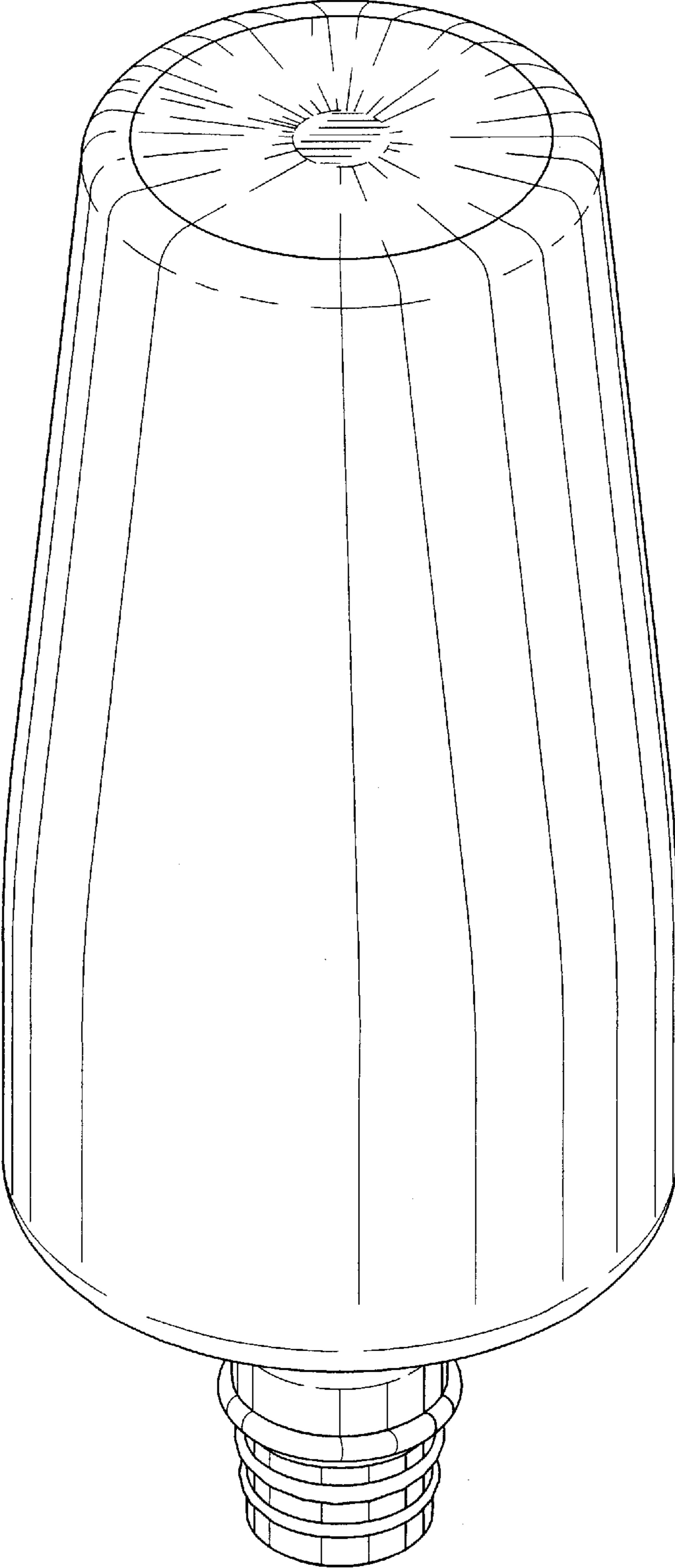

FIG. 3

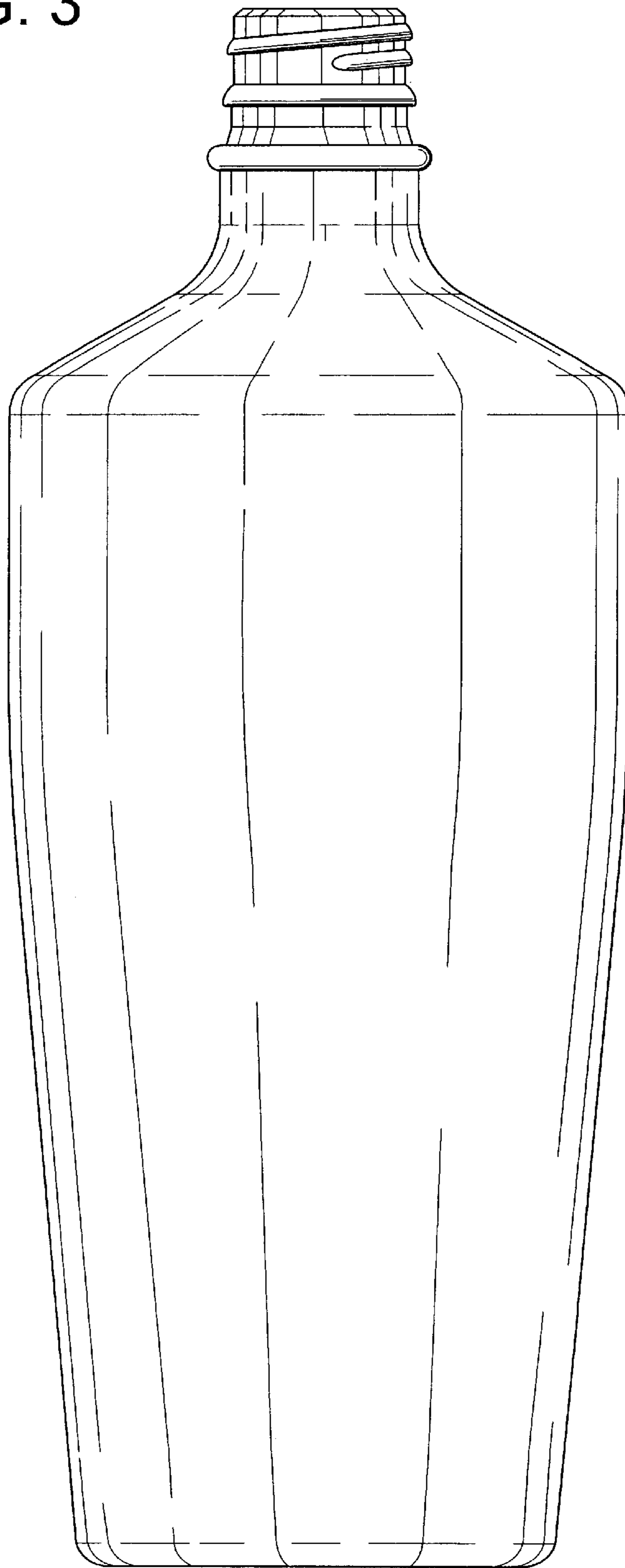

FIG. 4

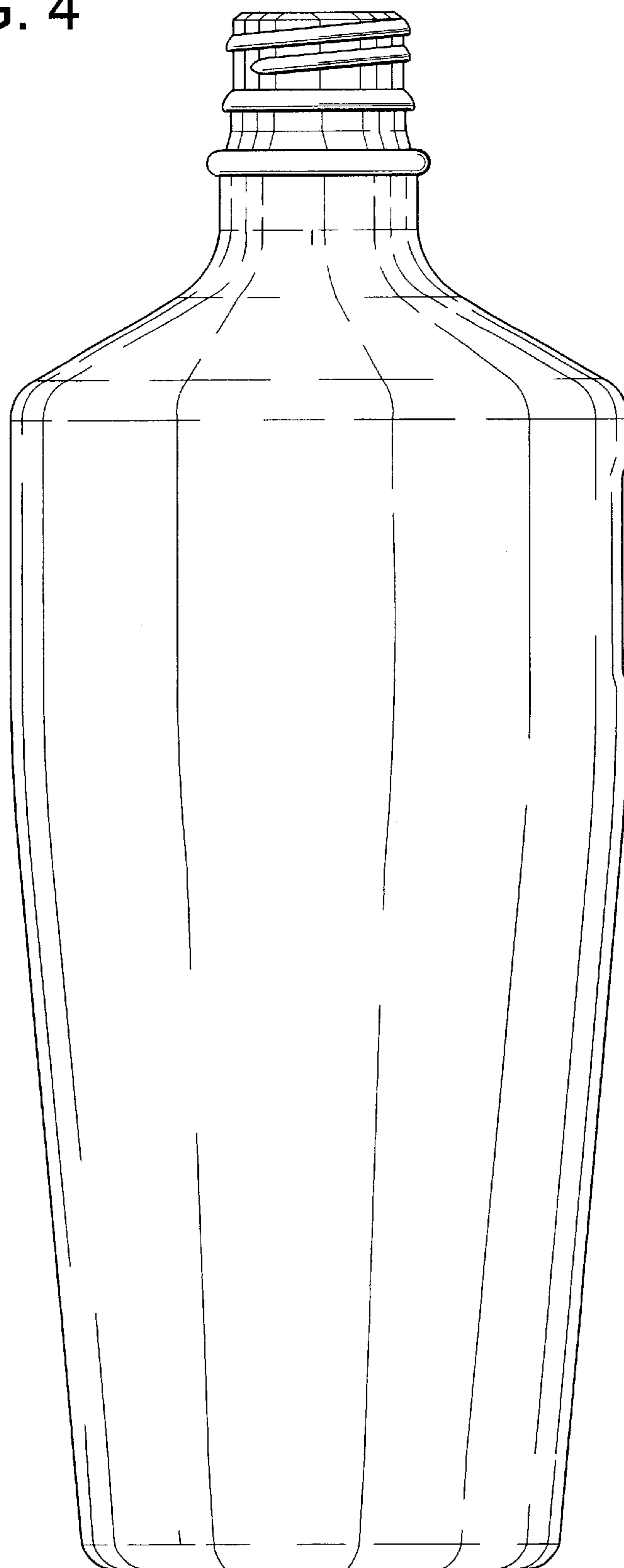

FIG. 5

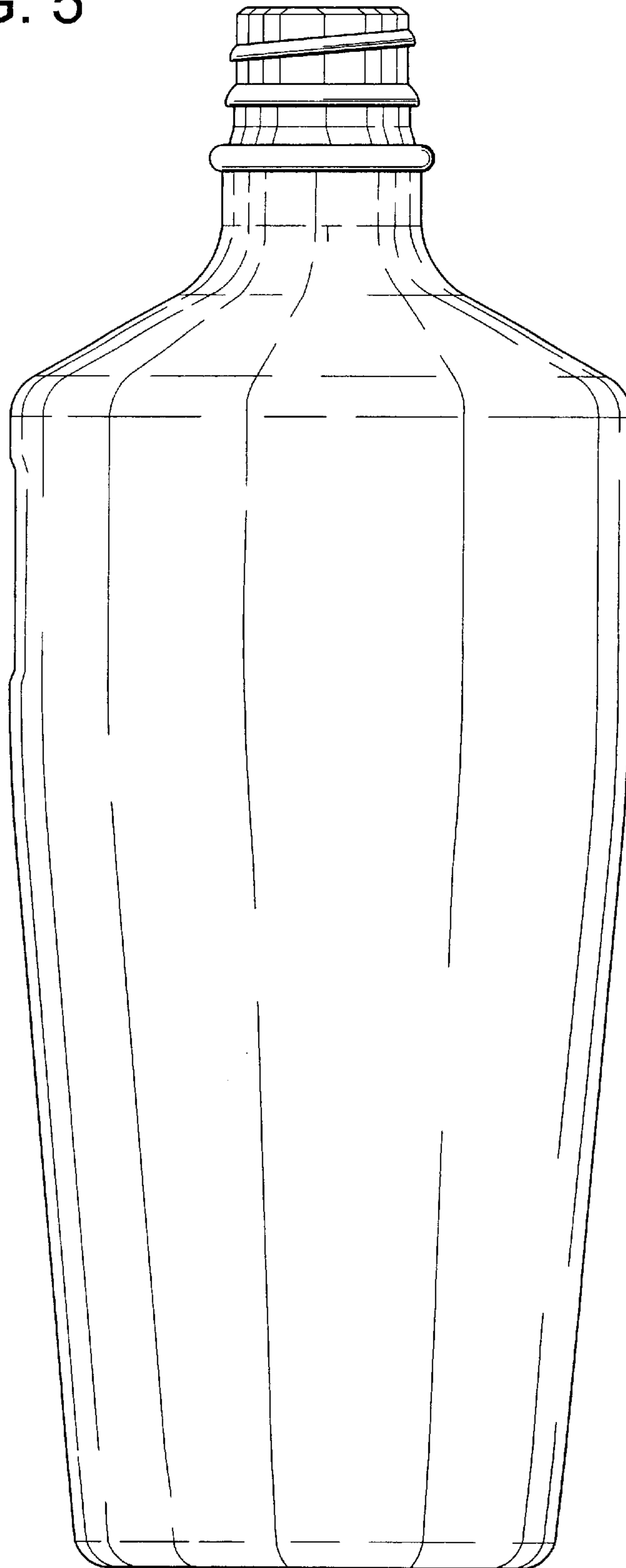

FIG. 6

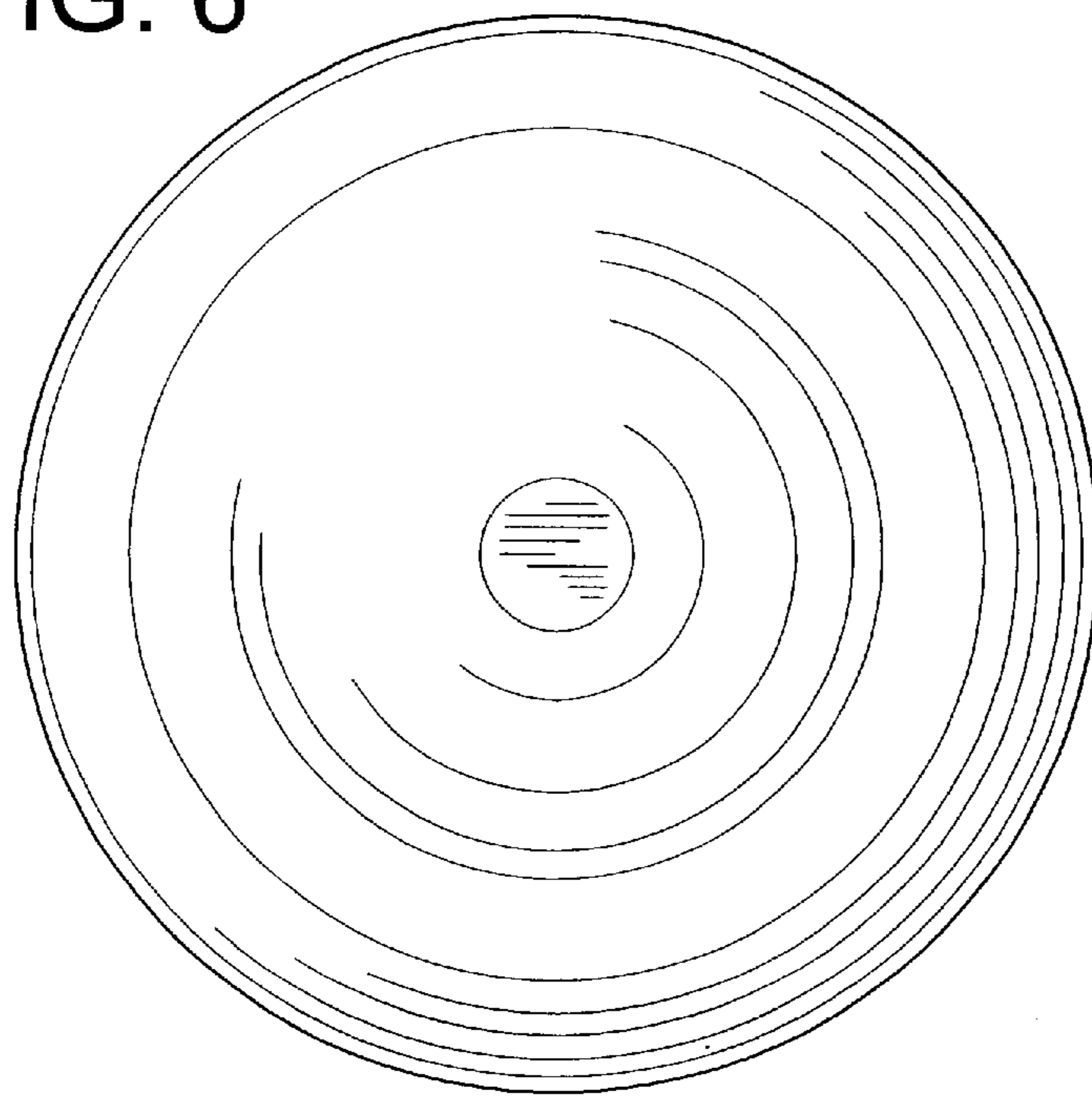

FIG. 7

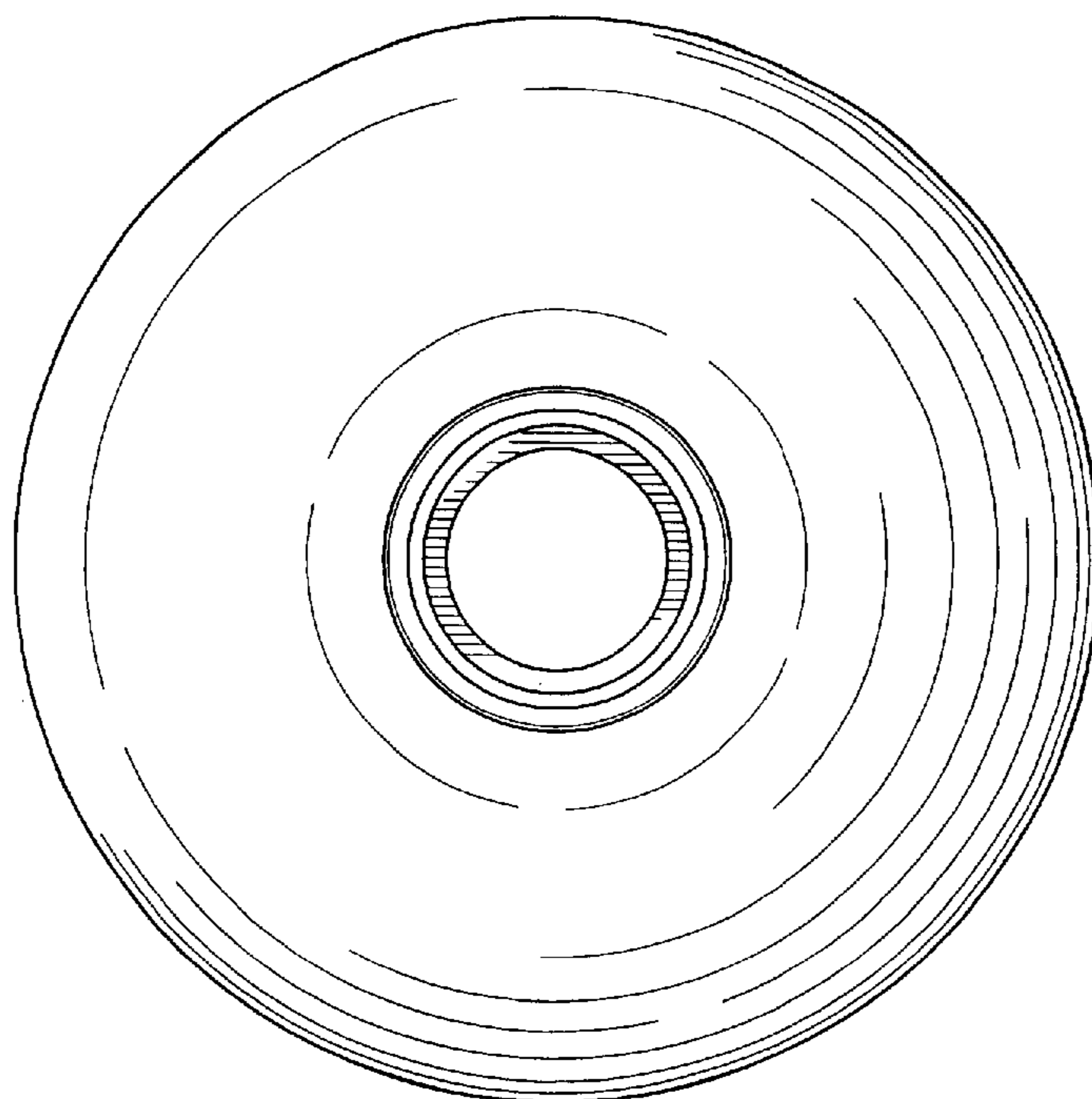

FIG. 8

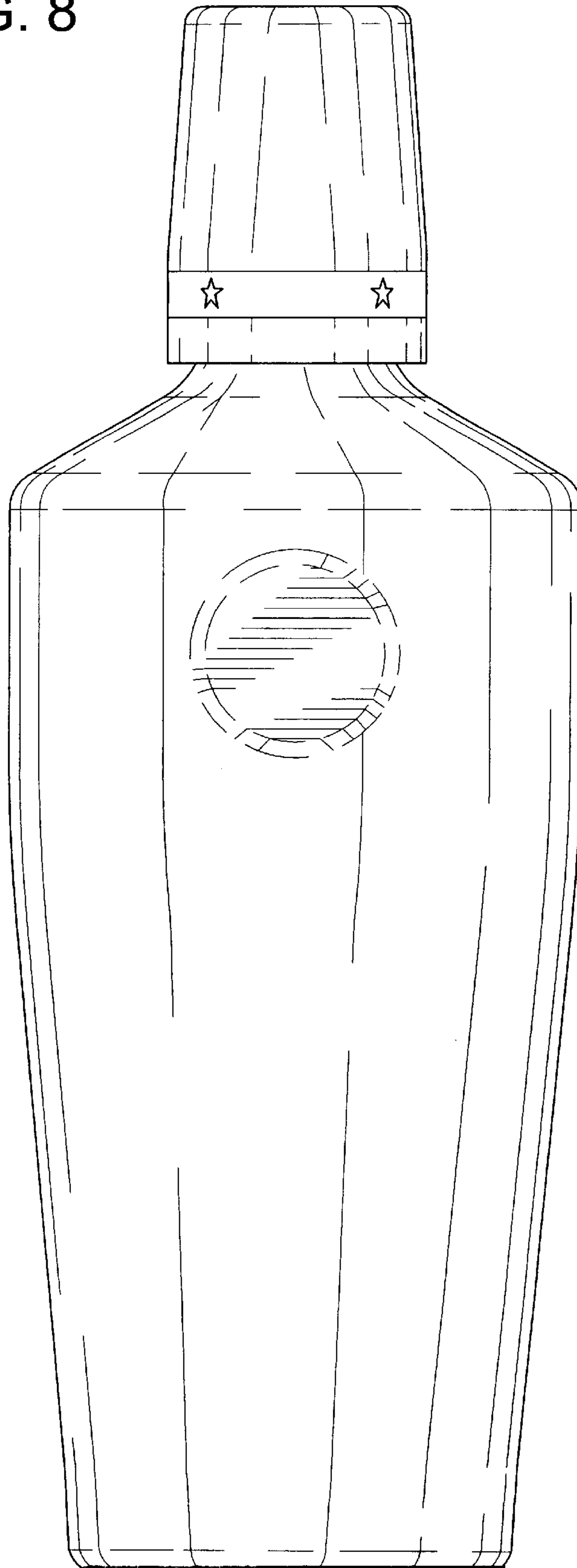

FIG. 9

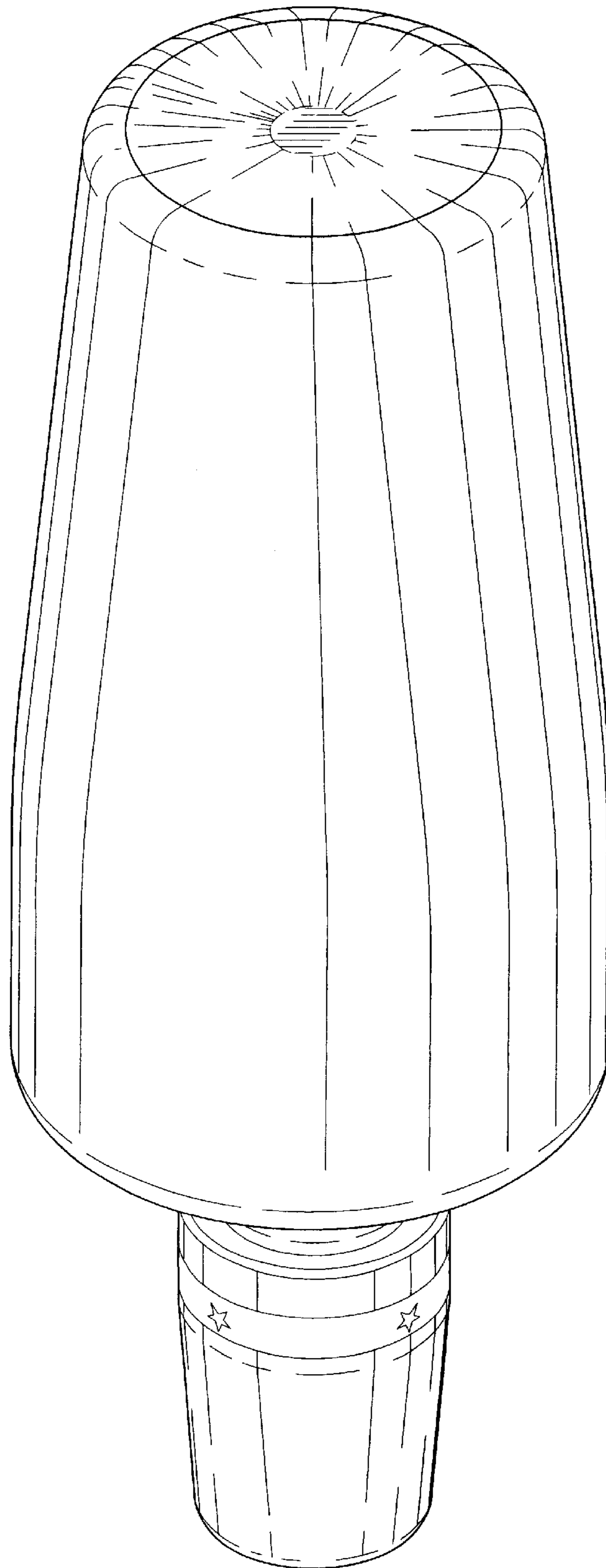

FIG. 10

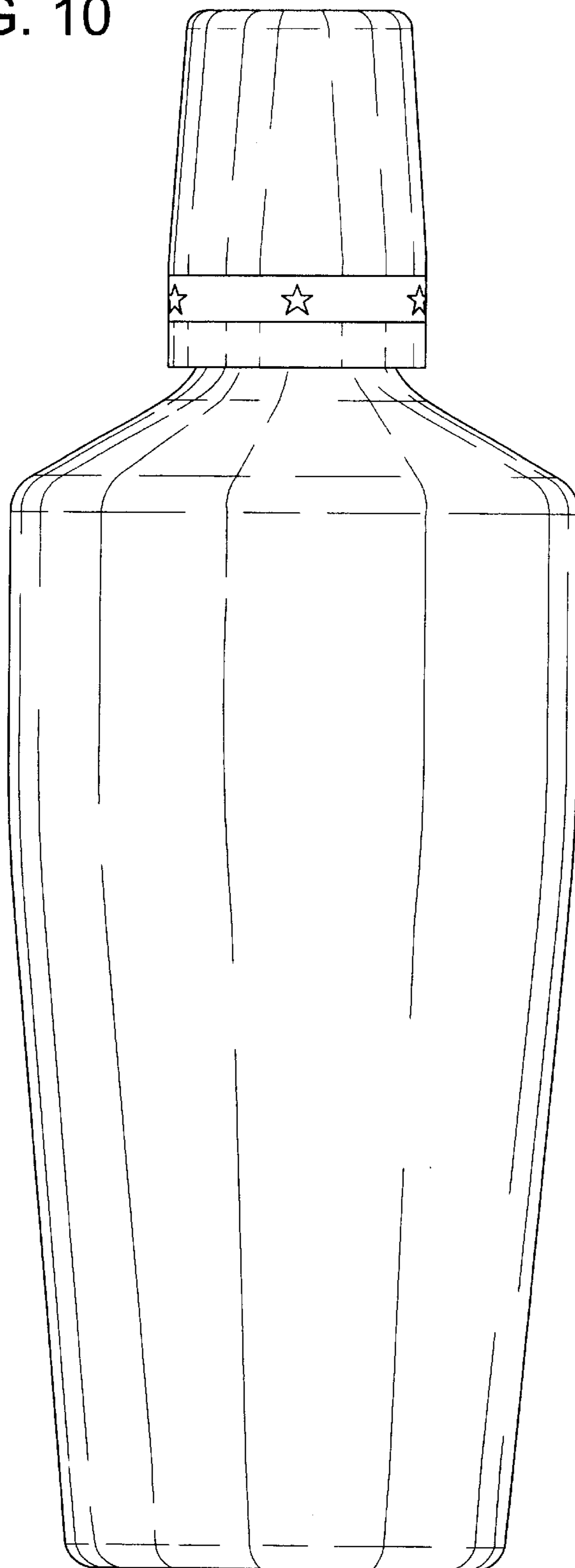

FIG. 11

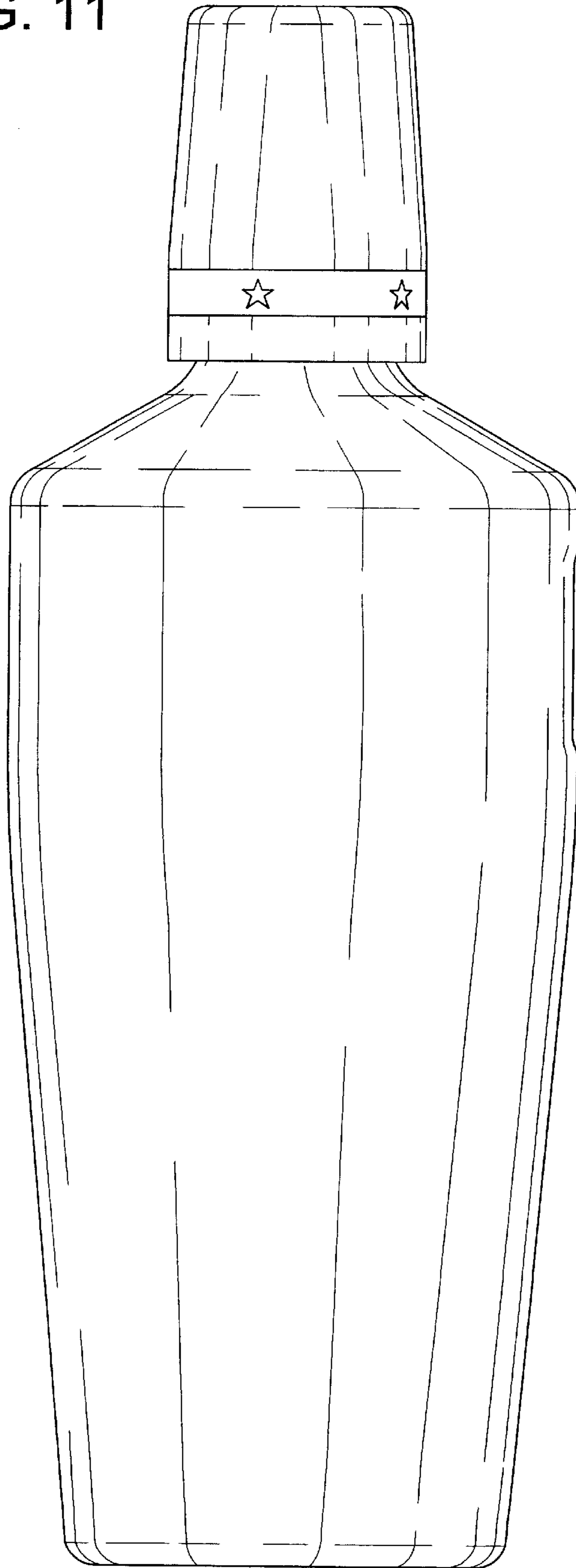

FIG. 12

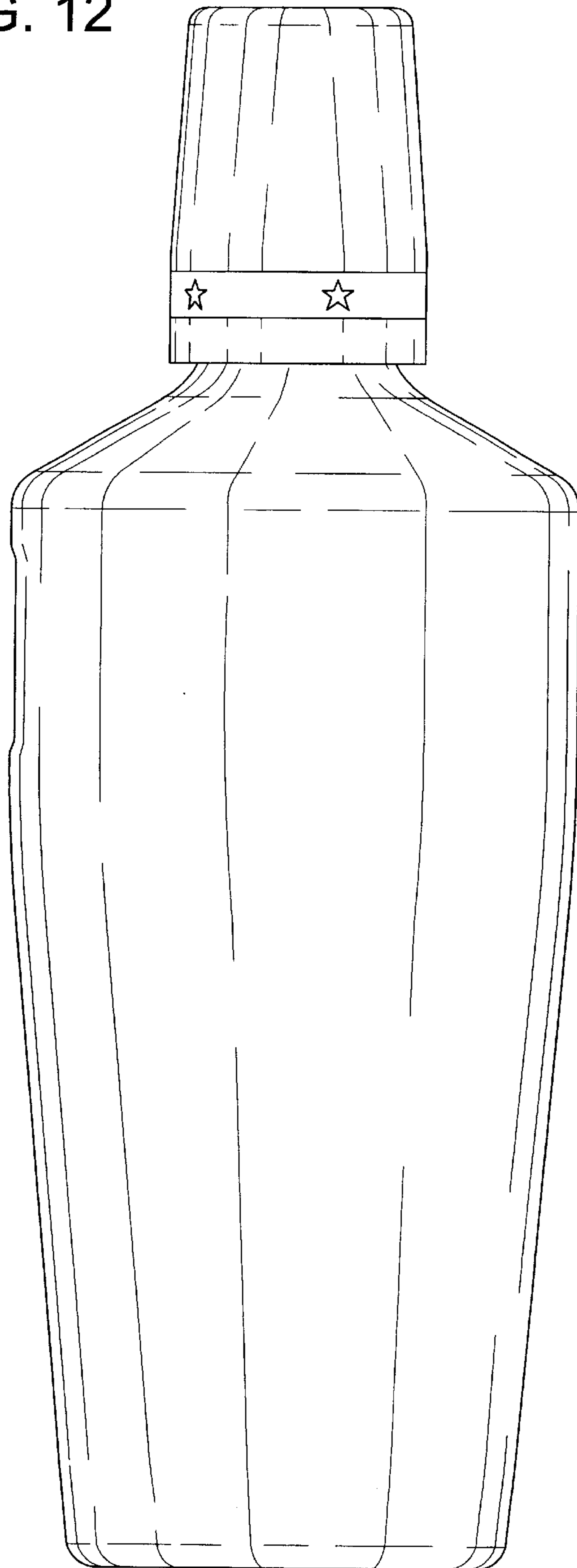

FIG. 13

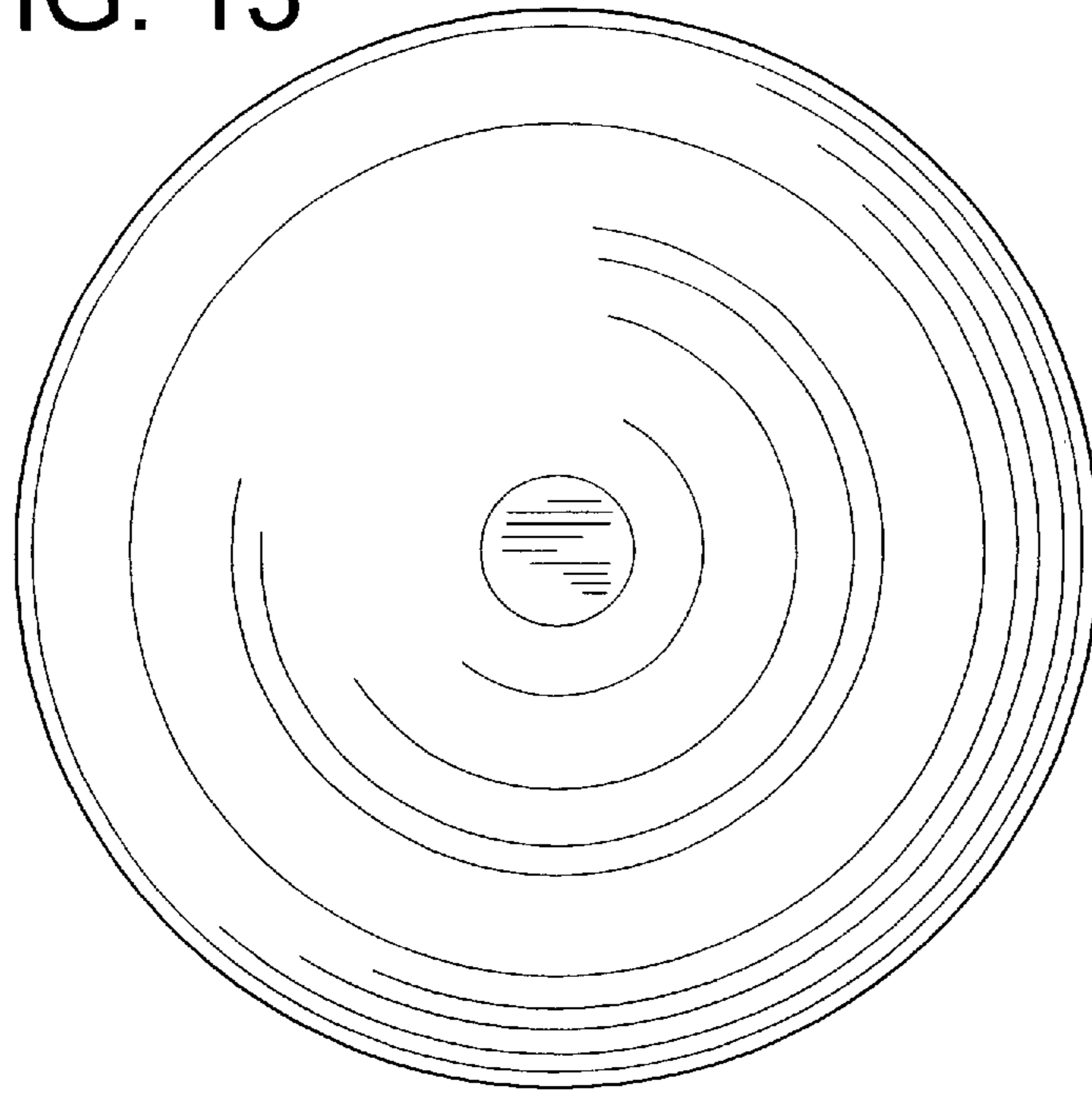

FIG. 14

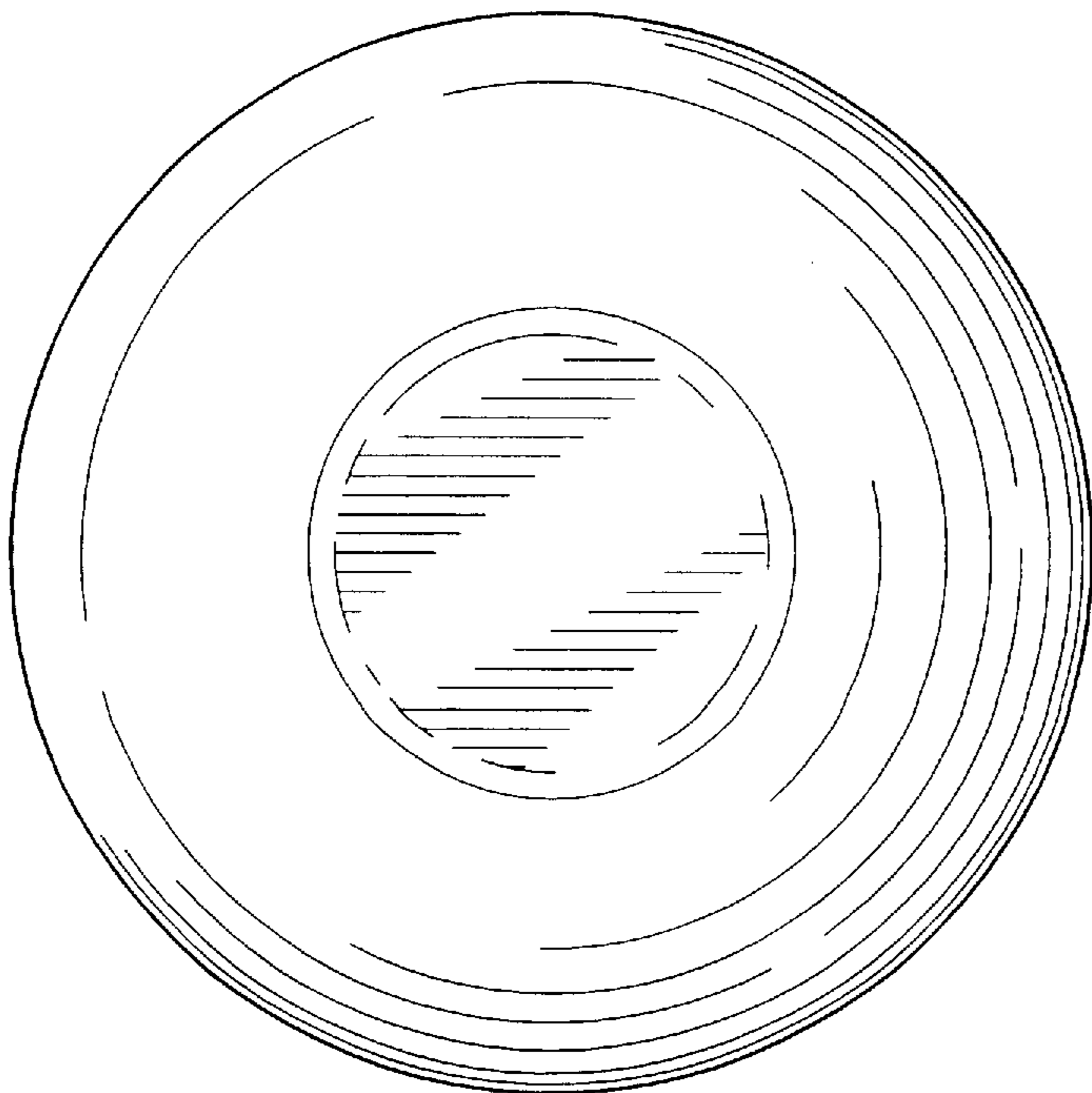

FIG. 15

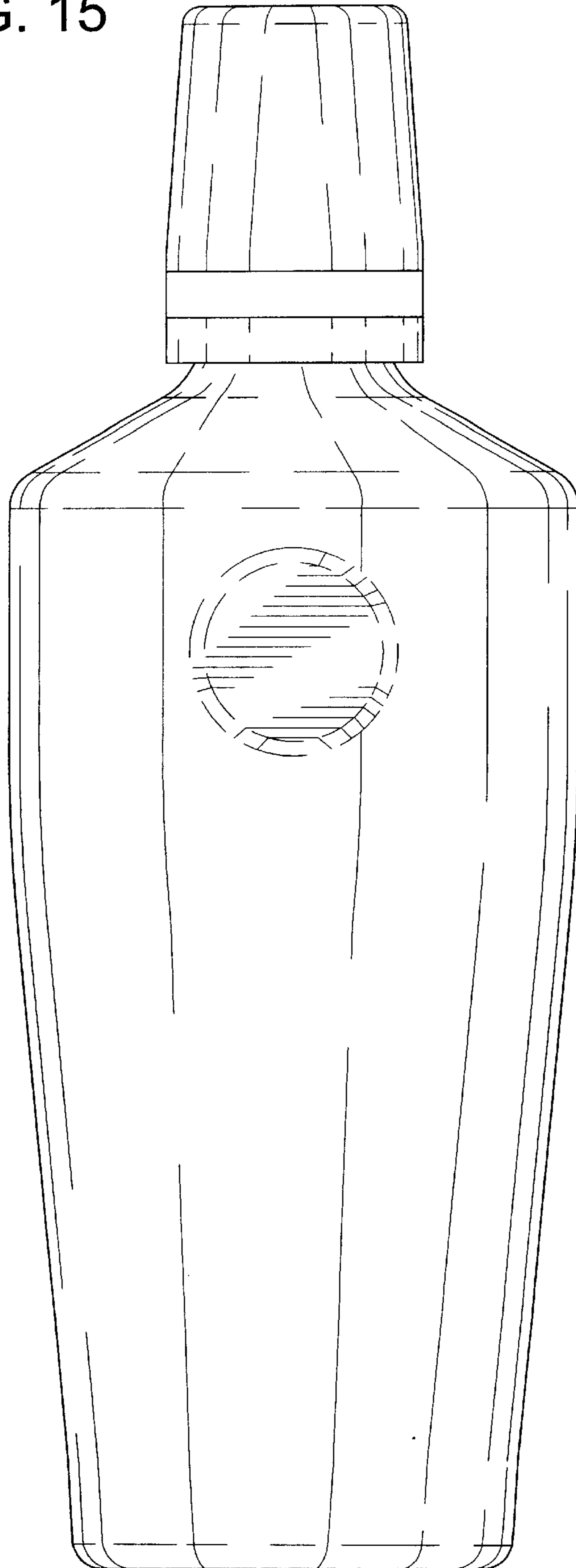

FIG. 16

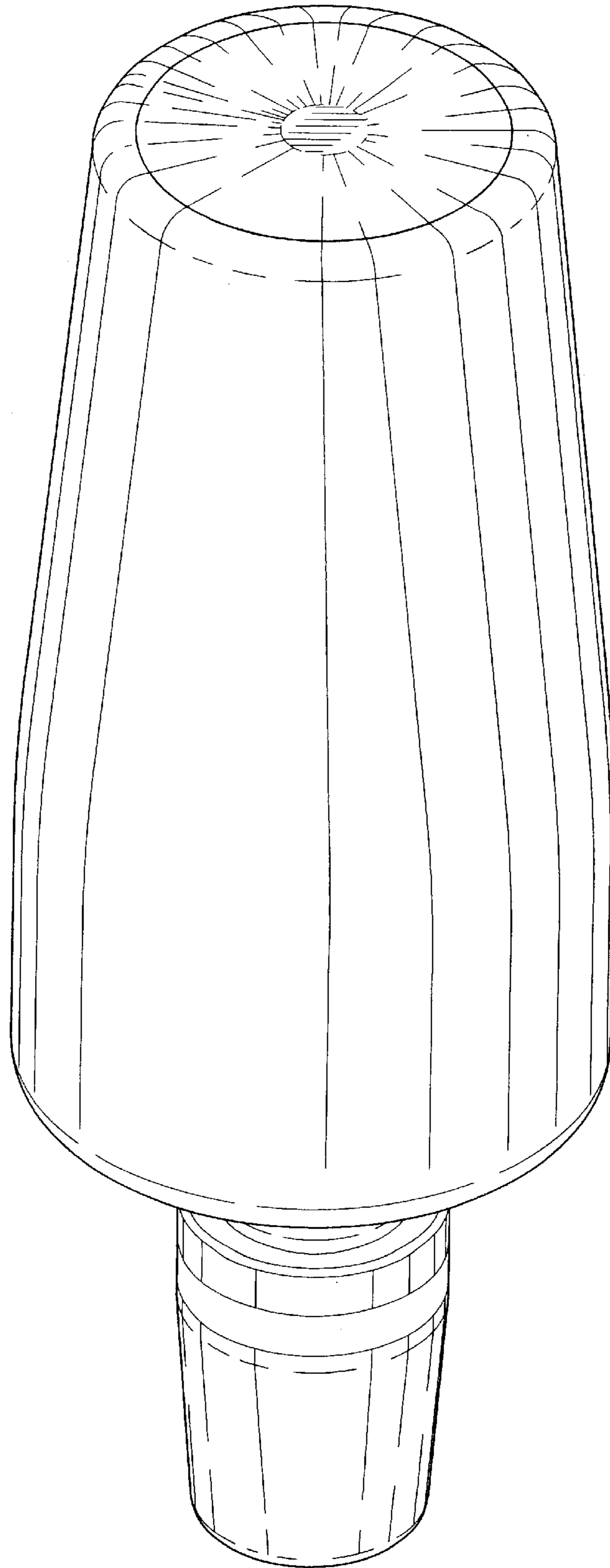

FIG. 17

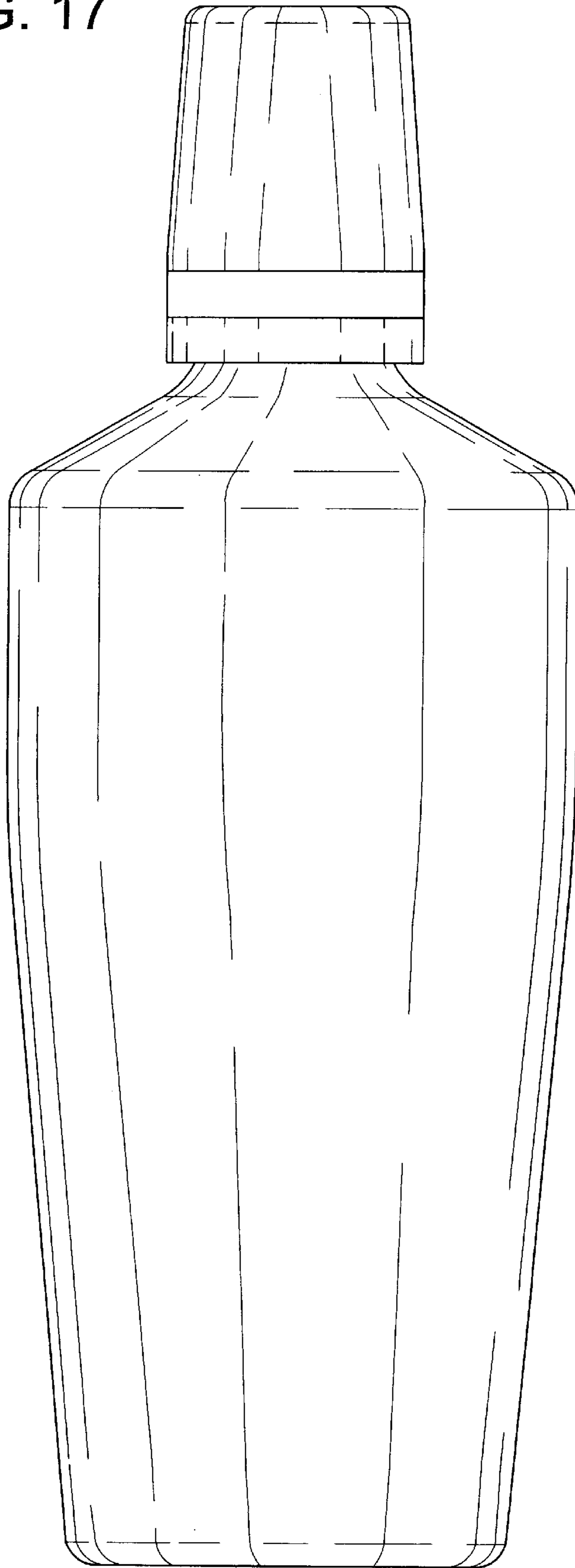

FIG. 18

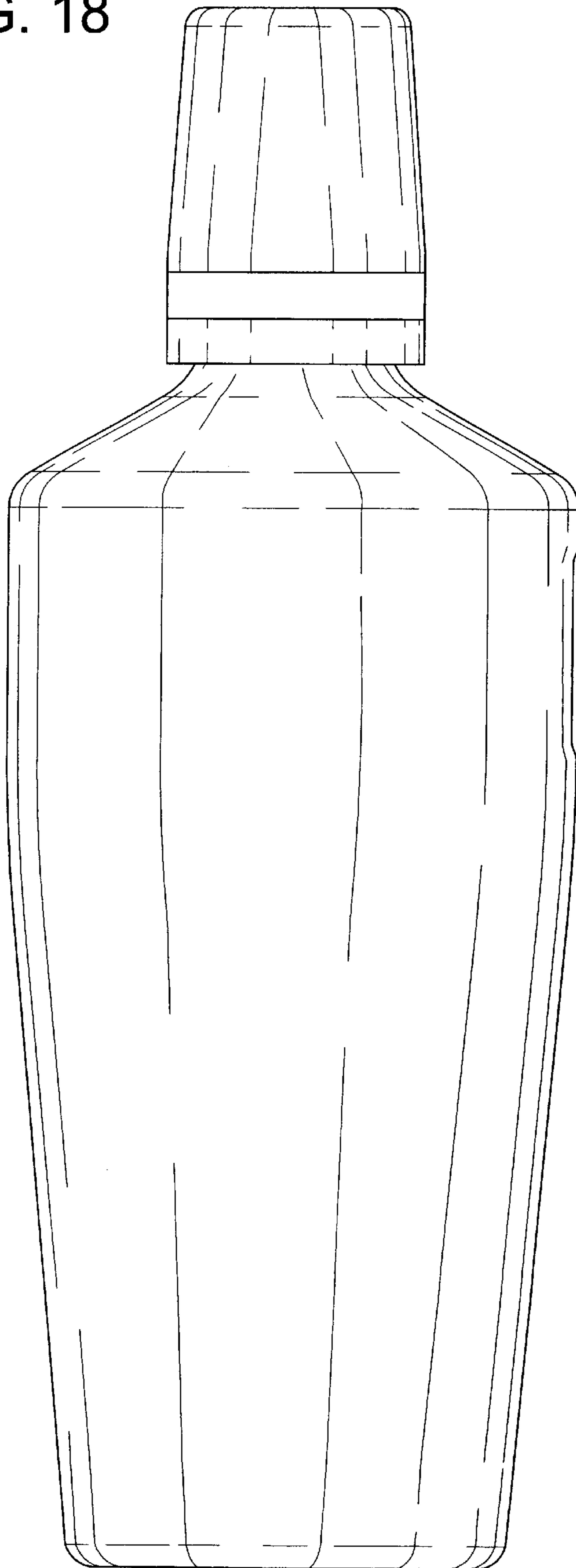

FIG. 19

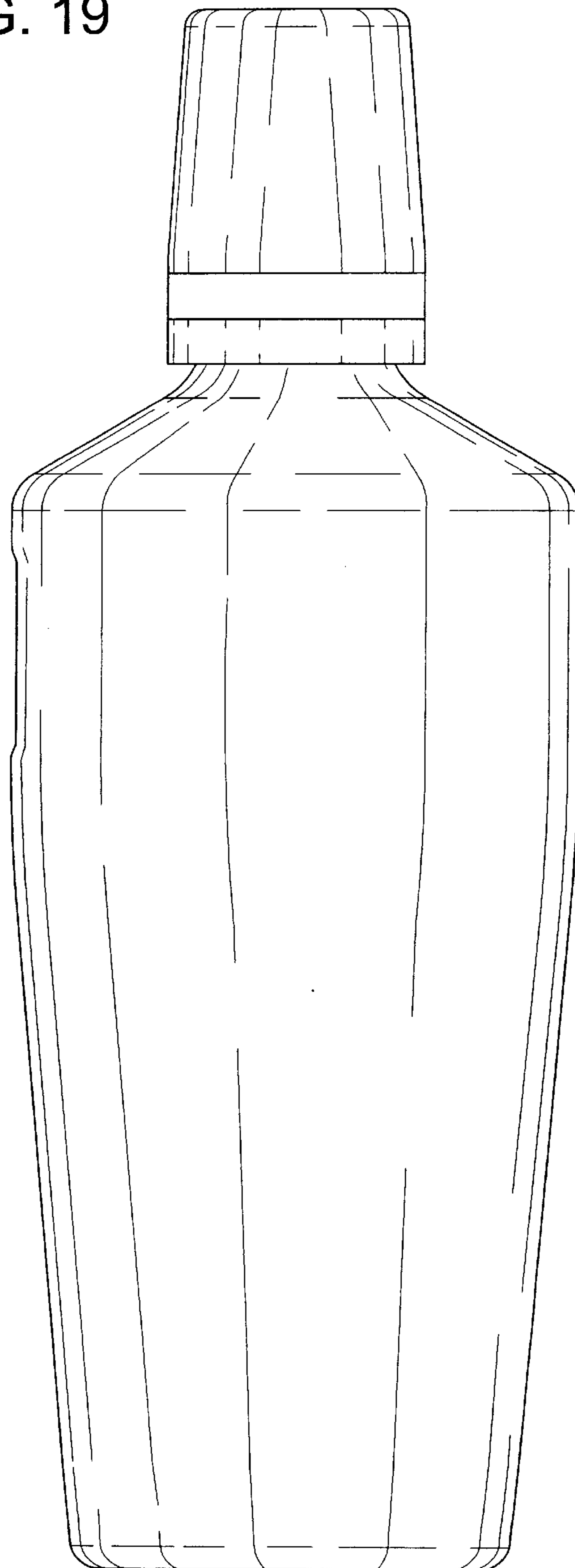

FIG. 20

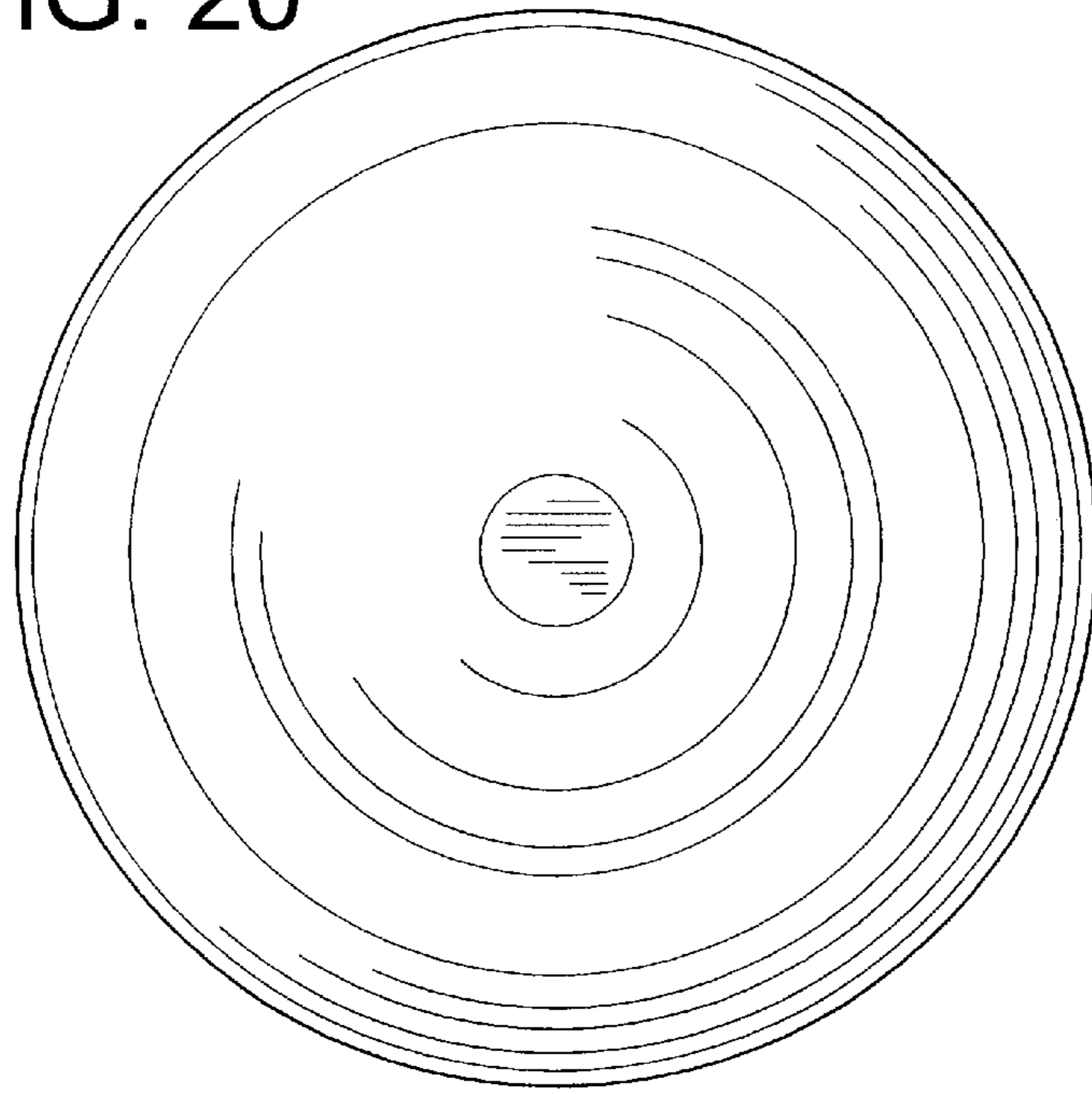

FIG. 21

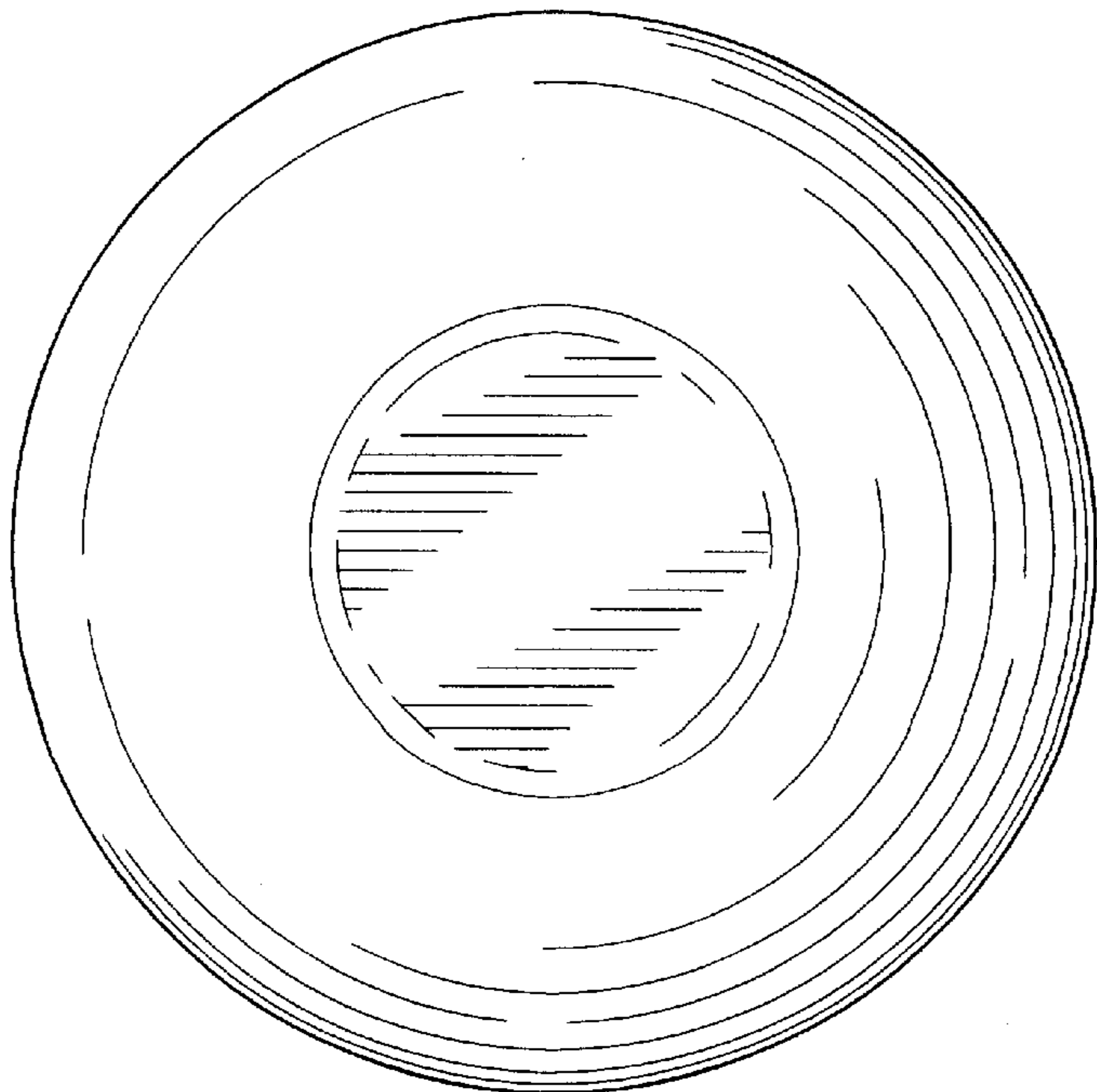

FIG. 22

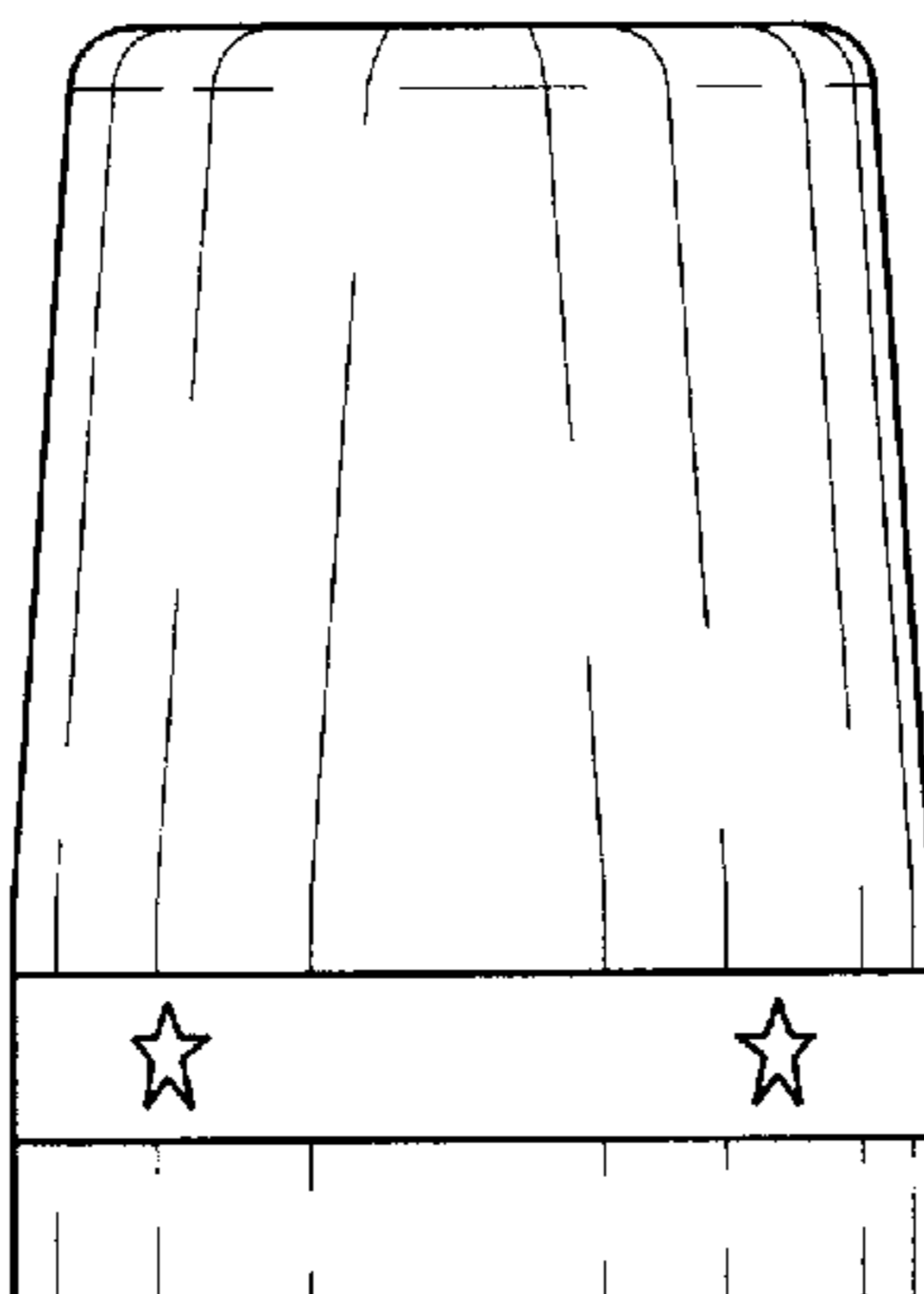

FIG. 23

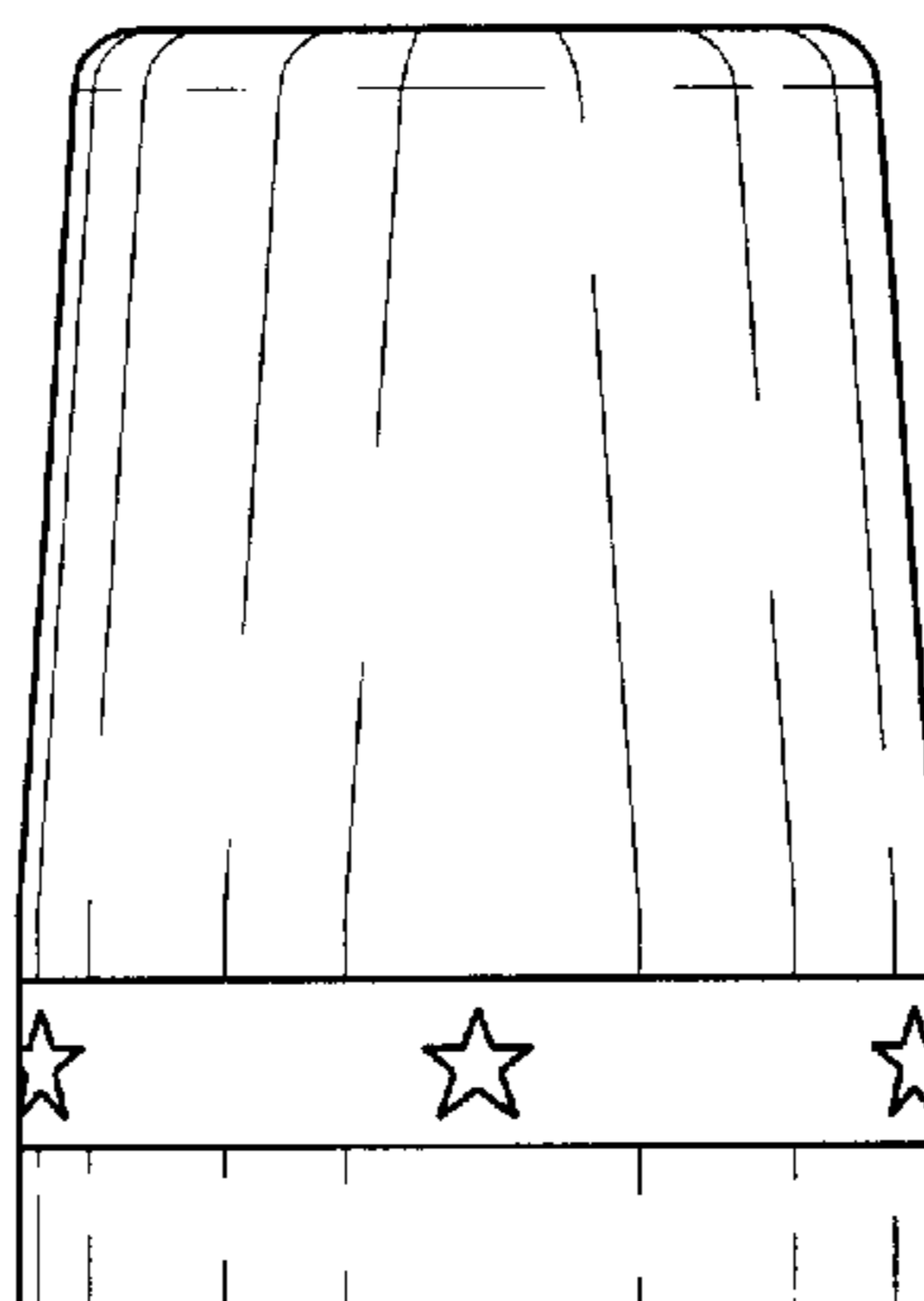

FIG. 24

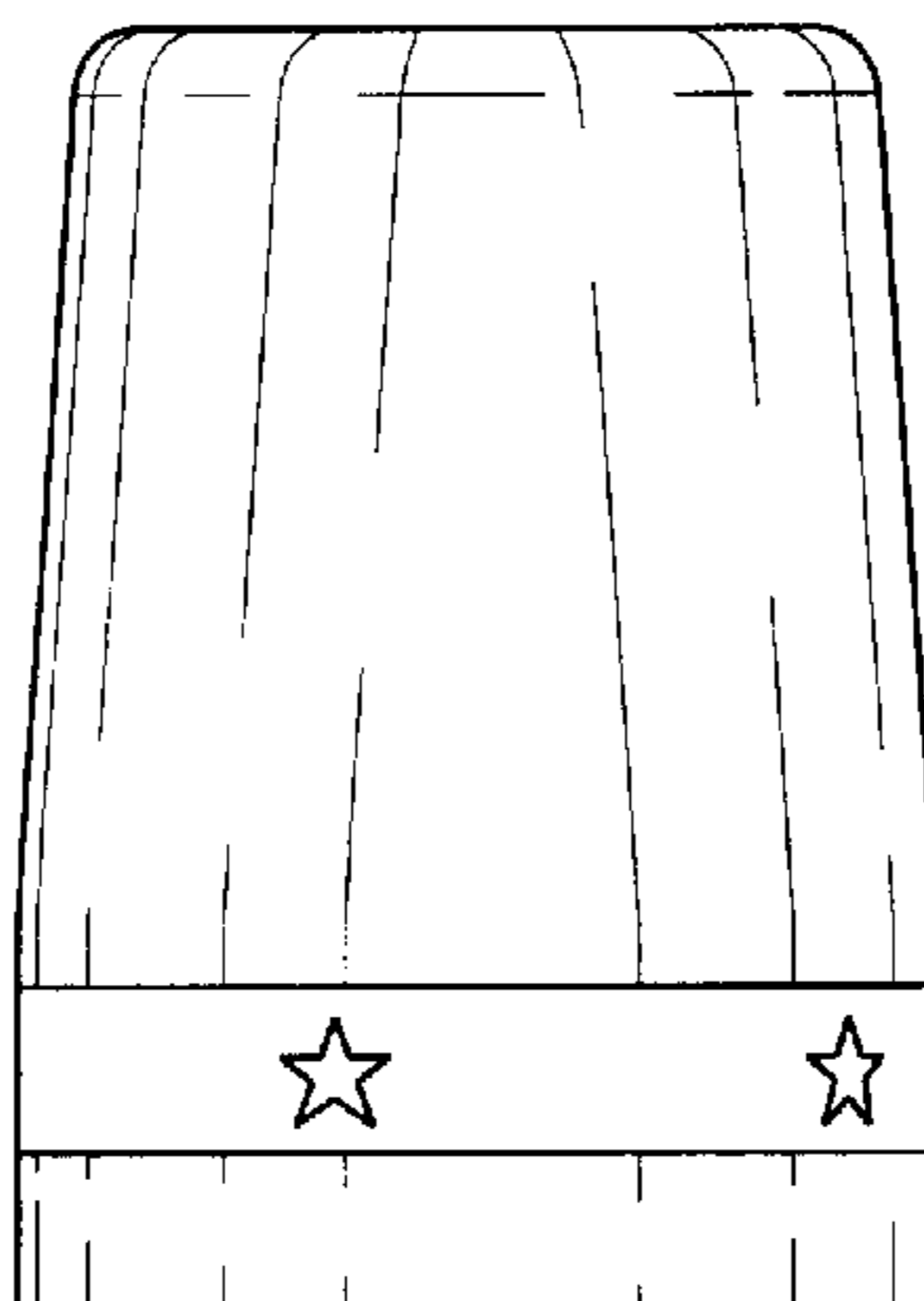

FIG. 25

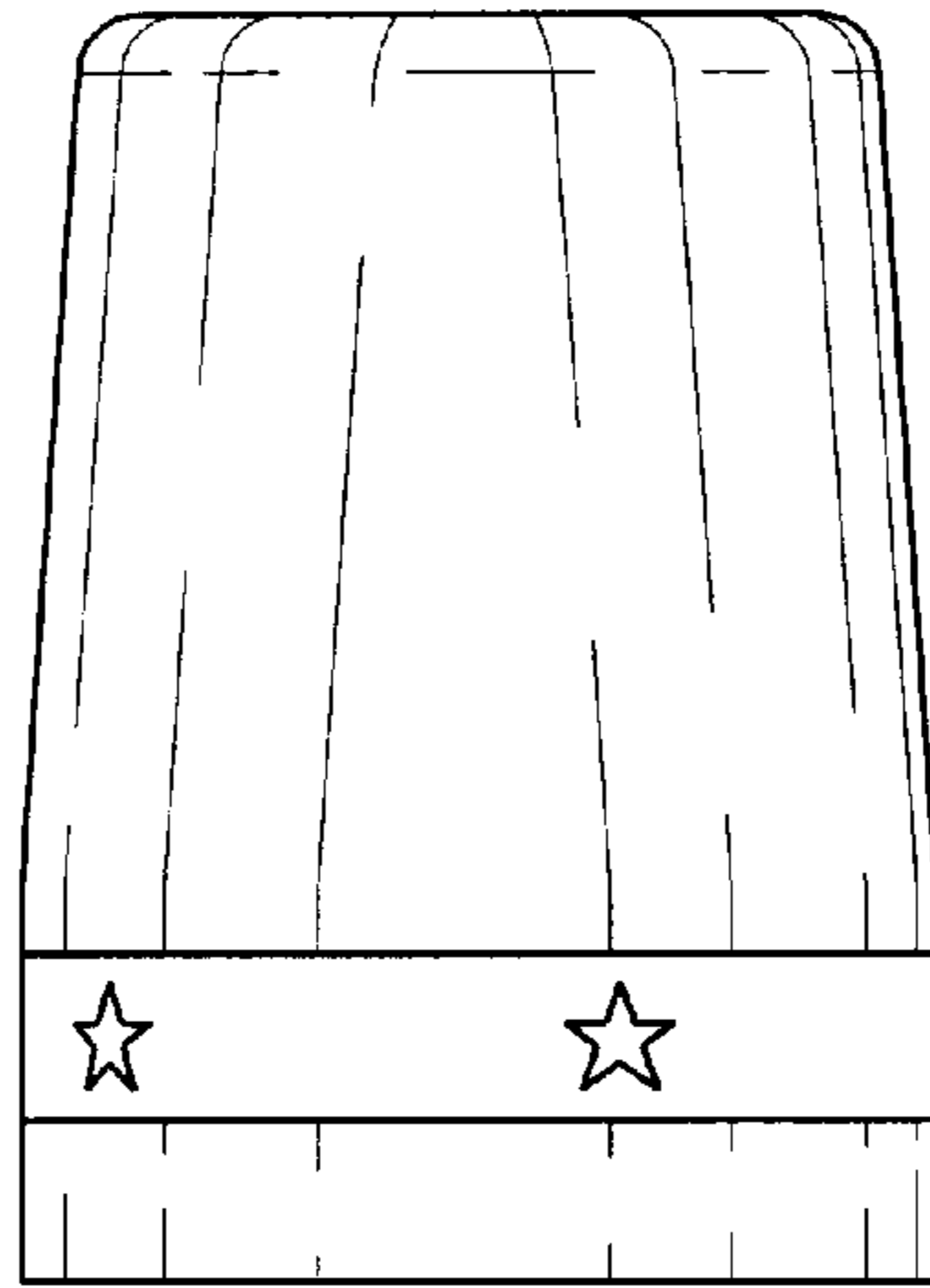

FIG. 26

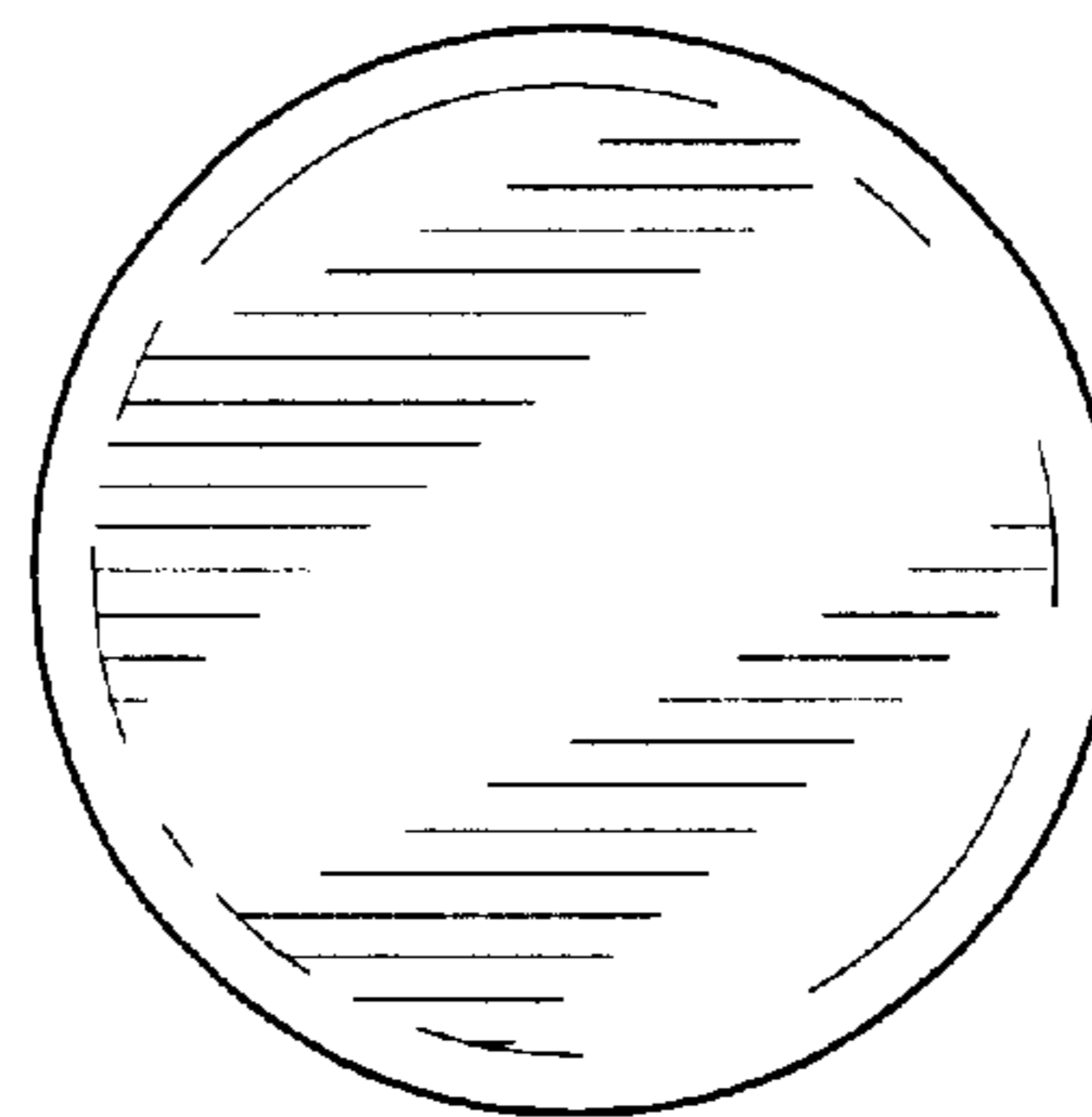

FIG. 27

